

# Vega Administration Guide

## Configuration and Management of Vega 50 Europa, Vega 400 and Vega 5000 Telephony Gateways



This admin guide covers firmware release 8.5  
for both SIP and H.323 protocols.

## Contents

<b>1</b>	<b>INTRODUCTION.....</b>	<b>8</b>
<b>2</b>	<b>POWER ON SELF TEST .....</b>	<b>9</b>
2.1	POWER ON SELF TEST (POST).....	9
2.2	RESULTS.....	9
2.3	STATUS LED FLASH PATTERNS.....	9
<b>3</b>	<b>VEGA IP ADDRESS.....</b>	<b>10</b>
3.1	DHCP BEHAVIOUR AND CONFIGURATION .....	10
3.1.1	<i>DHCP Enabled.....</i>	<i>10</i>
3.1.2	<i>DHCP Disabled.....</i>	<i>13</i>
3.2	FINDING OUT THE VEGA'S IP ADDRESS ON AN FXS GATEWAY .....	14
<b>4</b>	<b>DUAL BOOT H.323 / SIP .....</b>	<b>15</b>
4.1	DUAL BOOT INTRODUCTION .....	15
4.2	BOOT MANAGER AND AUTOEXEC INTERACTION .....	15
<b>5</b>	<b>USER INTERFACES .....</b>	<b>16</b>
5.1	COMMAND LINE INTERFACE (CLI).....	16
5.1.1	<i>Serial Connection.....</i>	<i>16</i>
5.1.2	<i>Telnet Connection .....</i>	<i>17</i>
5.1.3	<i>Web Interface .....</i>	<i>17</i>
5.2	CONFIGURATION/MANAGEMENT COMMAND SUMMARY .....	18
5.3	WEB BROWSER INTERFACE .....	26
5.4	DISABLING REMOTE USER INTERFACE ACCESS .....	26
5.5	TFTP AND FTP .....	27
5.5.1	<i>Choosing the protocol.....</i>	<i>27</i>
5.5.2	<i>Configuring TFTP.....</i>	<i>28</i>
5.5.3	<i>Configuring FTP .....</i>	<i>28</i>
<b>6</b>	<b>SYSTEM CONFIGURATION DATABASE .....</b>	<b>30</b>
6.1	CONFIGURATION STORAGE AND LAYOUT .....	30
6.2	SAVING AND RESETTING CONFIGURATION DATA.....	31
6.3	DISPLAYING CONFIGURATION VALUES .....	31
6.3.1	<i>Displaying Values Using The Command Line Interface.....</i>	<i>31</i>
6.4	CHANGING CONFIGURATION VALUES .....	36
6.4.1	<i>Changing Configuration Values Using The Web Browser .....</i>	<i>36</i>
6.4.2	<i>Changing Configuration Values Using The Command Line Interface.....</i>	<i>36</i>
6.5	MANIPULATING LIST SECTIONS .....	37
6.5.1	<i>Manipulating List Sections using the web browser.....</i>	<i>37</i>
6.5.2	<i>Manipulating List sections using the Command Line Interface .....</i>	<i>37</i>
6.6	ACTIVATING CONFIGURATION CHANGES .....	38
6.7	CONFIGURATION ENTRIES .....	38
6.8	ADVANCED CONFIGURATION ENTRIES .....	104
6.9	EXPORTING / IMPORTING CONFIGURATION DATA.....	138
<b>7</b>	<b>USER ADMINISTRATION.....</b>	<b>139</b>
7.1	DEFAULT USERS .....	139
7.1.1	<i>User Configuration .....</i>	<i>140</i>
7.2	CONFIGURABLE USERS .....	141
7.3	CHANGING USER PASSWORDS .....	142
7.4	RADIUS LOGIN AUTHENTICATION.....	142
7.4.1	<i>Configuration .....</i>	<i>142</i>
7.4.2	<i>Test Command.....</i>	<i>143</i>

7.5	LOGGED ON USERS .....	144
<b>8</b>	<b>THE DIAL PLANNER.....</b>	<b>146</b>
8.1	INTERFACES .....	147
8.2	DIAL PLAN TOKENS .....	148
8.3	DIAL PLANNER STRUCTURE.....	152
8.3.1	<i>Show Plan</i> .....	152
8.3.2	<i>Adding Plan Entries</i> .....	153
8.3.3	<i>Moving to a specific Dial Plan entry</i> .....	153
8.3.4	<i>Creating a Source Expression</i> .....	154
8.3.5	<i>Creating a Destination Expression</i> .....	154
8.3.6	<i>Regular Expressions</i> .....	155
8.3.7	<i>Adding a Cost Index</i> .....	156
8.4	FIXED LENGTH VS VARIABLE LENGTH.....	156
8.5	LONGEST MATCH AND COST MATCHING .....	156
8.5.1	<i>Cost Matching</i> .....	156
8.5.2	<i>Longest Matching</i> .....	156
8.5.3	<i>Show Paths Command</i> .....	157
8.5.4	<i>Try Command</i> .....	157
8.6	DIAL PLANNER GROUPS.....	157
8.6.1	<i>Groups And Redundancy (Call re-presentation)</i> .....	158
8.6.2	<i>Cause Codes For Re-Presentation</i> .....	159
8.6.3	<i>Groups enabling and disabling dial plans</i> .....	160
8.7	CALL PRESENTATION GROUPS.....	161
8.7.1	<i>Configuring a Call Presentation Group</i> .....	162
8.7.2	<i>Interaction of Call Presentation Groups and Call re-presentation</i> .....	162
8.8	HOT-LINE FACILITY (LONG-LINE EXTENSION) .....	163
8.8.1	<i>Vega FXS Port Hot-Line</i> .....	163
8.8.2	<i>Vega FXO Port Hot-Line</i> .....	163
8.8.3	<i>Vega 50 BRI and Vega 400 Hot-Line</i> .....	164
8.9	OVERLAP DIALLING.....	165
8.9.1	<i>Configuration</i> .....	165
8.9.2	<i>Example Usage</i> .....	165
8.9.3	<i>Sample Call Flow for SIP Overlap Dialling</i> .....	166
8.10	LOCALDNS NAME TABLE OR DNS-BASED INDIRECTION.....	167
8.11	NATIONAL / INTERNATIONAL DIALLING – TYPE OF NUMBER.....	168
8.11.1	<i>_advanced.setup_mapping</i> .....	168
8.11.2	<i>planner.post_profile</i> .....	169
8.11.3	<i>Calling Party Telephone number prefix based on TON</i> .....	171
8.12	TESTING PLAN ENTRIES .....	172
8.13	CALL SECURITY – WHITELIST ACCESS LISTS.....	172
<b>9</b>	<b>LOGGING AND STATISTICS.....</b>	<b>173</b>
9.1	SYSTEM EVENT LOG .....	173
9.1.1	<i>Call Tracing using the Event Log</i> .....	175
9.1.2	<i>Reboot cause codes</i> .....	177
9.2	STATISTICS .....	178
9.2.1	<i>Show Calls</i> .....	178
9.2.2	<i>Show Ports</i> .....	180
9.2.3	<i>Configuration</i> .....	181
9.2.4	<i>Test Command</i> .....	181
9.2.5	<i>Status Sockets</i> .....	183
9.2.6	<i>Show lan routes</i> .....	183
9.2.7	<i>Show Lancfg</i> .....	184
9.2.8	<i>Show Version</i> .....	185
9.2.9	<i>Show Trace</i> .....	185
9.2.10	<i>Show Stats</i> .....	185
9.2.11	<i>Show Syslog</i> .....	187
9.2.12	<i>Showdsp</i> .....	188
9.2.13	<i>Dspdiag</i> .....	189

9.3	SHOW SUPPORT.....	190
9.4	CDRs – CALL DETAIL RECORDS.....	191
9.4.1	CDR Billing via serial / telnet.....	191
9.4.2	CDR Billing via Radius accounting records.....	192
9.4.3	QoS (Quality of Service) CDRs.....	193
<b>10</b>	<b>CONFIGURATION FOR E1T1 AND BRI VEGAS.....</b>	<b>194</b>
10.1	SYSTEM VARIANTS.....	194
10.2	GENERAL CONFIGURATION FOR E1T1 AND BRI VEGAS.....	194
10.2.1	Network Type, Topology and Line Encoding.....	194
10.2.2	Companding Type.....	194
10.2.3	B-channel Grouping.....	195
10.2.4	B-channel Allocation Strategies.....	195
10.2.5	Inband progress tones.....	196
10.2.6	Cause code mapping.....	196
10.2.7	Bus master.....	197
10.2.8	Vega 400 Bypass Relays.....	197
10.2.9	Specific T1 configuration.....	198
10.2.10	Specific E1 configuration.....	199
10.3	ISDN SPECIFIC CONFIGURATION.....	199
10.3.1	Introduction.....	199
10.3.2	ISDN Network Type, Topology and Line Encoding.....	200
10.3.3	NT/TE Configuration.....	200
10.3.4	Specific BRI configuration.....	201
10.3.5	Verifying ISDN IEs (Information Elements).....	203
10.3.6	Call Hold.....	203
10.4	QSIG SPECIFIC CONFIGURATION.....	203
10.4.1	Introduction.....	203
10.4.2	QSIG Network Type, Topology and Line Encoding.....	203
10.4.3	NT/TE or Master/Slave Configuration.....	204
10.4.4	Overlap Dialling.....	205
10.4.5	Type of Number configuration.....	205
10.4.6	Message Waiting Indication.....	205
10.4.7	QSIG Un-Tromboning.....	206
10.5	TUNNELLING SIGNALLING DATA.....	208
10.5.1	QSIG Tunneling (H323 Only).....	208
10.5.2	Tunnelling Non-QSIG Signaling Messages (H323 Only).....	209
10.5.3	Tunnelling full signalling messages and IEs in ISDN (ETSI, ATT, DMS, DMS-M1, NI, VN 3/4) and QSIG.....	211
10.6	CAS T1 SPECIFIC CONFIGURATION.....	212
10.6.1	RBS CAS Network Type, Topology, Signal type and Line Encoding.....	212
10.6.2	Configuring dial_format.....	213
10.6.3	NT/TE Configuration.....	214
10.7	CAS E1 SPECIFIC CONFIGURATION.....	214
10.7.1	E1 CAS R2MFC.....	214
<b>11</b>	<b>POTS CONFIGURATION.....</b>	<b>215</b>
11.1	FXS SUPPLEMENTARY SERVICES.....	215
11.1.1	Call Transfer.....	215
11.1.2	Three Way Calling.....	216
11.1.3	Call Forwarding.....	219
11.1.4	Do Not Disturb.....	223
11.1.5	Call Waiting.....	225
11.2	POTS PHONE FACING (FXS) PORTS.....	225
11.2.1	DTMF digit detection.....	225
11.2.2	Hook Flash detection.....	225
11.2.3	Ring Cadence Generation.....	225
11.2.4	Line supervision – Answer and disconnect.....	226
11.2.5	DTMF digits after answer.....	227
11.3	POTS NETWORK FACING (FXO) PORTS.....	227

11.3.1	Line voltage detection .....	227
11.3.2	Impedance configuration .....	227
11.3.3	DTMF digit generation .....	228
11.3.4	Hook Flash generation.....	228
11.3.5	Ring Cadence Detection.....	228
11.3.6	Line Supervision – Answer and Disconnect .....	229
11.3.7	Tone Detection .....	230
11.3.8	FXO – Slow network clear-down .....	232
11.3.9	FXO – Secondary dial tone .....	232
11.4	ANALOGUE CALLER-ID (CLID) .....	233
11.4.1	FXS – Outbound Analogue Caller ID (CLID) – H.323 and SIP.....	234
11.4.2	FXO – Analogue Caller ID detection (CLID) – H.323 and SIP .....	234
11.5	POWER FAIL FALLBACK OPERATION .....	235
<b>12</b>	<b>H.323 CONFIGURATION.....</b>	<b>236</b>
12.1	STANDALONE MODE .....	237
12.2	GATEKEEPER MODE.....	237
12.3	GATEKEEPER REGISTRATION STATUS COMMAND AND MESSAGES .....	238
12.4	GATEKEEPER REGISTRATION COMMANDS .....	238
12.5	FAST START .....	239
12.6	EARLY H.245 .....	239
12.7	H.245 TUNNELLING .....	240
12.8	ROUND TRIP DELAY .....	240
12.8.1	Round trip delay (RTD) operation.....	240
12.9	H.450 – FOR CALL TRANSFER / DIVERT .....	241
12.9.1	Introduction.....	241
12.9.2	H.450.2 – Call Transfer.....	241
12.9.3	H.450.3 – Call Diversion (For test purposes only).....	242
12.9.4	H.450 Configuration .....	243
<b>13</b>	<b>MEDIA .....</b>	<b>244</b>
13.1	MEDIA CHANNELS AND CODECS .....	244
13.1.1	H.323 Media Channels and CODECS.....	244
13.1.2	SIP Media Channels and CODECS.....	246
13.1.3	CAPDESC – Capability descriptors list.....	247
13.1.4	Defining Fax capabilities.....	248
13.2	SIP MEDIA CHANNELS AND CODECS.....	249
13.3	SIP AND H.323 - CONFIGURING CODEC PARAMETERS.....	249
13.4	G.729 / G.729 ANNEX A/B CODECS .....	251
13.5	OUT OF BAND DTMF (OOB DTMF).....	252
13.5.1	H.323 out of band DTMF.....	252
13.5.2	SIP out of band DTMF .....	252
13.6	TONES .....	252
13.6.1	Configuring Local Call Progress Tones.....	252
13.6.2	Fixed Tone Table.....	254
13.6.3	Selecting Generation of Progress Tones vs Media Pass Through.....	255
13.7	SYMMETRIC RTP / DYNAMIC RTP .....	262
<b>14</b>	<b>FAX, MODEM AND DATA CALLS.....</b>	<b>263</b>
14.1	FAX AND MODEM OPERATION.....	263
14.1.1	SIP handling of Fax and modem calls.....	264
14.1.2	H.323 handling of Fax and modem calls.....	264
14.2	CONFIGURATION PARAMETERS FOR FAX / MODEM HANDLING.....	265
14.2.1	Recommended Values For SIP FAX / Modem Connectivity.....	267
14.3	ISDN UNRESTRICTED DIGITAL INFORMATION BEARER CAPABILITY AND CLEAR MODE .....	268
<b>15</b>	<b>SIP GATEWAYS .....</b>	<b>269</b>
15.1	INTRODUCTION.....	269
15.2	MONITOR COMMANDS .....	269
15.3	REGISTRATION STATUS COMMANDS .....	270

15.3.1	<i>SIP SHOW REG</i> .....	270
15.3.2	<i>SIP SHOW REG [user]</i> .....	270
15.3.3	<i>SIP REG user</i> .....	271
15.3.4	<i>SIP REG ALL</i> .....	271
15.3.5	<i>SIP CANCEL REG user</i> .....	271
15.3.6	<i>SIP CANCEL REG ALL</i> .....	271
15.3.7	<i>SIP RESET REG</i> .....	271
15.4	<b>SIP CONFIGURATION</b> .....	271
15.4.1	<i>TCP / UDP SIP</i> .....	272
15.4.2	<i>Proxy</i> .....	272
15.4.3	<i>SIP SDP 'a=' ptime and direction attributes</i> .....	276
15.4.4	<i>Registration – Vega 400, Vega BRI, Vega FXS, Vega FXO</i> .....	282
15.4.5	<i>Authentication – Vega 400, Vega BRI, Vega FXS, Vega FXO</i> .....	284
15.4.6	<i>Incoming INVITEs</i> .....	284
15.4.7	<i>Local and Remote Rx Ports</i> .....	284
15.4.8	<i>PRACK Support</i> .....	285
15.4.9	<i>REFER/REPLACES</i> .....	285
15.4.10	<i>RPID – Remote Party ID header</i> .....	286
15.4.11	<i>RFC 3323 Privacy header and RFC 3325 extensions</i> .....	288
15.4.12	<i>Session Timers</i> .....	291
15.4.13	<i>Phone Context Headers</i> .....	292
15.4.14	<i>User Defined String in SIP To / From Headers</i> .....	294
15.5	<b>RFC2833</b> .....	295
15.5.1	<i>RFC2833 Configuration</i> .....	295
15.6	<b>EXECUTIVE INTERRUPT</b> .....	296
15.6.1	<i>Configuring NameSpace for Resource-Priority Headers</i> .....	297
15.6.2	<i>Resource-Priority for SIP calls initiated by Vega gateways</i> .....	298
15.7	<b>SIP MUSIC ON HOLD (MOH)</b> .....	299
15.8	<b>MULTIPLE SIP SIGNALLING PORTS</b> .....	299
15.9	<b>TDM CHANNEL INFORMATION</b> .....	300
15.10	<b>SIP STATUS CODES</b> .....	301
15.10.1	<i>1xx - SIP Provisional Responses Supported</i> .....	301
15.10.2	<i>2xx - SIP Success Codes Supported</i> .....	301
15.10.3	<i>3xx - SIP Redirection Codes Supported (Responded To)</i> .....	301
15.10.4	<i>4xx - SIP Request Failure Codes Supported</i> .....	302
15.10.5	<i>5xx - SIP Server Failure Codes Supported</i> .....	303
15.10.6	<i>6xx - SIP Global Failure Codes Supported (Generated and Responded To)</i> .....	304
<b>16</b>	<b>ENHANCED NETWORK PROXY</b> .....	<b>305</b>
16.1	<b>DESCRIPTION</b> .....	305
16.2	<b>ENP'S MODES OF OPERATION</b> .....	305
16.2.1	<i>Standalone Proxy Mode</i> .....	305
16.2.2	<i>Forward To ITSP Mode</i> .....	306
16.2.3	<i>ITSP Trunking Mode</i> .....	306
16.3	<b>ENP CONFIGURATION DETAILS</b> .....	306
<b>17</b>	<b>SNMP MANAGEMENT</b> .....	<b>319</b>
17.1	<b>SNMP CONFIGURATION</b> .....	319
17.2	<b>SNMP ENTERPRISE OBJECT-ID</b> .....	319
17.3	<b>TRAP SUPPORT</b> .....	319
<b>18</b>	<b>UPGRADES AND MAINTENANCE</b> .....	<b>320</b>
18.1	<b>UPGRADING THE VEGA FIRMWARE</b> .....	320
18.2	<b>THE BOOT-TIME RECOVERY MENU</b> .....	320
18.2.1	<i>Reset System configuration and Clear Passwords</i> .....	320
18.2.2	<i>Switch Active Boot Partition (- Reverting to a Previous Firmware Image)</i> .....	320
<b>19</b>	<b>AUTOEXEC SCRIPT</b> .....	<b>322</b>
19.1	<b>THE SCRIPT FILE</b> .....	322
19.2	<b>A TYPICAL SCRIPT FILE</b> .....	322

19.3	SCRIPT FILE - PERMITTED COMMAND SET .....	323
19.4	CLI COMMAND EXTENSIONS .....	323
19.5	CONFIGURING AUTOEXEC PARAMETERS.....	326
19.6	SCRIPTFILE NAME – EXPANDABLE CHARACTERS .....	326
19.7	STATUS REPORTING .....	327
19.8	EXAMPLE SEQUENCE OF EVENTS.....	327
19.9	SIP NOTIFY TRIGGERED AUTOEXEC.....	328
<b>20</b>	<b>WORKING WITH FIREWALLS.....</b>	<b>330</b>
20.1	NAT.....	330
<b>21</b>	<b>QUALITY OF SERVICE (QOS) .....</b>	<b>332</b>
21.1	QOS MARKING OF LAN PACKETS.....	332
21.1.1	Layer 3 (IP header) – Type Of Service bits.....	332
21.1.2	Layer 2 (Ethernet Header) – 802.1p Class of Service tagging and 802.1q VLAN tagging .....	334
21.1.3	Configuring QOS Profiles.....	335
21.2	QOS EVENT MONITORING .....	338
21.3	QOS STATISTICS REPORTS .....	338
	<b>APPENDIX A: SYSTEM EVENT LOG MESSAGES .....</b>	<b>339</b>
	<b>APPENDIX B: SIP SIGNALLING MESSAGES .....</b>	<b>343</b>
	<b>APPENDIX C: DTMF TONE FREQUENCIES .....</b>	<b>348</b>
	<b>APPENDIX D: HEXADECIMAL TO DECIMAL CONVERSION.....</b>	<b>349</b>

## 1 INTRODUCTION

This Vega administration guide provides detailed information about the features available on Vega platforms and how to configure them. It is very useful as a technical reference document, but also provides a good overview of the capabilities of the Vega platforms.

Vega gateways may be loaded with either H.323 or SIP runtime firmware. Some of the features documented in this primer are only available in SIP units, others available only on H.323 products – but most are available on both.

Release R8.5 is available for the following hardware platforms:

- Vega 400
- Vega 50 Europa BRI / FXS / FXO
- Vega 5000

VegaStream strives for constant improvement; if you have any comments about this document please forward them to [support@vegastream.com](mailto:support@vegastream.com).



## 2 POWER ON SELF TEST

### 2.1 Power On Self Test (POST)

Every time a Vega is powered on or rebooted it goes through a power on self test. The success or failure of the POST is indicated on the bank of LEDs.

### 2.2 Results

On power up and re-boot the Vega illuminates all the E1T1/ BRI / channel LEDs. After POST testing completes, either all LEDs are extinguished and the Vega continues to boot as usual, or if a problem is found then the LEDs flash indefinitely in alternating banks of 4 LEDs (every half second).

NOTE
------

The alternating bank of 4 LEDs flashing is used to indicate POST problems to distinguish it from the all on / all flashing scenarios that can be seen if a Vega 50 FXS or FXO has the wrong configuration for the NT (Network Termination) parameter.

### 2.3 STATUS LED flash Patterns

If the Vega finds itself in a condition where it cannot take calls it will flash its Status LED (labeled 'RDY' on older gateways).

Usually the LED will be off until either there is a status to report, in which case it will flash, or until the Vega is ready to take calls in which case the LED will be on permanently.

The flash pattern indicates the status; the flash pattern used starts with a Dot followed by a Dash and terminated with a pause where the LED is off, i.e.:

Dot, Dash, 4 Dot/Dash status values, pause, repeat.

The status values are:

Flash Pattern				Status	Priority
Dot	Dot	Dot	Dot	No IP address received from DHCP server ... Fixed Apipa-compatible IP address configured on LAN 1	2
Dot	Dot	Dot	Dash	Firmware update attempted and failed (autoexec / cron)	6
Dot	Dot	Dash	Dot	Config update attempted and failed (autoexec / cron)	4
Dot	Dot	Dash	Dash	Vega is in factory reset configuration	5
Dot	Dash	Dot	Dot	Vega in Bypass mode	7
Dot	Dash	Dot	Dash		
Dot	Dash	Dash	Dot	Calls blocked	3
Dot	Dash	Dash	Dash	Duplicate IP address found	1

If the Vega is in more than one of the above states at the same time, the priority indication indicates which message will be displayed Priority 1 is shown in preference to priority 2 etc.

### 3 VEGA IP ADDRESS

Vega gateways are capable of using a dynamic, DHCP delivered IP address or a static, user configured IP address.

#### 3.1 DHCP Behaviour and Configuration

By default the Vega will try and pick up an IP address on each of its connected LAN interfaces from any DHCP server attached to that interface. Use this IP address to communicate with the Vega.

Vegas can be configured either to pick up certain IP parameters from a DHCP (Dynamic Host Configuration Protocol) server, or they can be configured with static values.

`lan.if.x.use_dhcp` controls whether the Vega makes use of DHCP to collect the values.

##### 3.1.1 DHCP Enabled

With `lan.if.x.use_dhcp=1`, the Vega's IP address and the LAN subnet mask are obtained using DHCP.

Additionally, if any of the following are set to 1, the corresponding IP parameter is also obtained from the DHCP server:

```
[lan.if.1.dhcp]
  get_dns
  get_gateway
  get_ntp
  get_tftp
```

If any of the `[lan.if.1.dhcp]` values are set to 0, or DHCP fails to obtain a requested value (including ip address and subnet mask), the Vega will use the locally configured parameter value configured as per DHCP Disabled (Section [3.1.2 "DHCP Disabled"](#)).

NOTE
------

1. If a SAVE is carried out on a Vega which has collected IP values using DHCP it will update the saved versions of those parameters with these latest values (including `lan.if.x.ip` and `lan.if.x.subnet`).
2. If DHCP is enabled but the Vega cannot reach a DHCP server for any reason, the LCD display on the front panel may go blank for 1 minute after performing the Power On Self Test before completing initialisation and reporting "No IP Address"
3. Vegas request a permanent lease on the IP address.
4. If there is a saved `lan.if.x.ip` address – the Vega will request lease of this IP address when it makes the DHCP request.

5. An IP address value 255.255.255.255 is used to indicate that the Vega has requested an IP address from the DHCP server, has not received a reply yet, but that the DHCP timeout has not been exceeded. A displayed IP address 0.0.0.0 when `use_dhcp=1`, indicates that the DHCP server did not respond with an IP address within the DHCP protocol timeout. (The Vega will at regular intervals request the DHCP server to lease an IP address – in case it comes back on line).

6. If the DHCP server disappears (does not respond to the Vega requesting an extension of a DHCP IP address lease), the Vega will continue to use the old IP address (so that existing and future calls to the gateway do not fail), but it will keep polling the DHCP server until it gets a response. When the DHCP server does respond, if the lease is renewed, then the Vega continues operation, if however the DHCP server will not renew that IP address the Vega re-boots to allow a new IP address to be activated.

7. If the DHCP server does not respond at Vega boot time, but then does start responding, the Vega will initiate a re-boot to allow a new IP address to be activated.

### 3.1.1.1 Default IP Address When DHCP Enabled

If the Vega is connected to a network which does not have a DHCP server, after the DHCP protocol times out the Vega will start up with a default IP address.

The default IP address that the Vega sets itself to is 169.254.xxx.yyy

- xxx and yyy are defined by the MAC address of the Vega
- xxx and yyy are both one to three digit decimal values.

The MAC address of the Vega LAN interface can be found on the rear of the Vega, on the barcode label above the LAN interfaces; it will be 00:50:58:WW:XX:YY

- where WW, XX and YY are each 2 hexadecimal digits.
- the LAN 1 MAC address is the same value as the serial number of the Vega and is always even.
- the LAN 2 MAC address – if there is a LAN 2 – is LAN 1 MAC address plus 1, and so is always odd.

The xxx value in the IP address is the decimal value of the XX hex value from the MAC address.

The yyy value in the IP address is the decimal value of the YY hex value from the MAC address.

*A hexadecimal to decimal conversion table may be found in Appendix D at the end of this document.*

*An IP calculator is available on [www.VegaAssist.com](http://www.VegaAssist.com), choose Vega Tools > IP Address Calculator. This will provide the required IP address based on a typed in MAC address.*

If a PC is configured to use DHCP and it does not receive an IP address from the DHCP server it too will default its IP address; using the APIPA (Automatic Public IP Addressing) standard PCs' default their IP addresses to 169.254.aaa.bbb with a subnet mask of 255.255.0.0

If your PC does not configure itself with an IP address of this form then manually configure the PC to that IP address and subnet. aaa and bbb can both be any value between 1 and 254, but bbb must be different to the Vega's yyy.

The Vega can now be contacted (using telnet or the web browser) using the IP address 169.254.xxx.yyy

You can set a new IP address for the Vega once you have initially connected to it.

The Vega will create and use a default IP address rather than waiting for ever for a DHCP address if:

```
[lan]
  use_apipa=1
```

and either

```
[lan]
  use_dhcp=1
```

and no DHCP address was received when it was requested

or

```
[lan]
  use_dhcp=0
```

and

```
[lan.if.x]
  ip=0.0.0.0 or ip=255.255.255.255
```

Note:

If neither LAN port is able to get a DHCP address, only the 1st LAN will be given a 169.254.xxx.yyy address. (Vega gateways do not allow Both LAN 1 and Lan 2 on the same IP subnet).

#### **3.1.1.1.1 Practical aspects of using APIPA compatible operation**

When using APIPA deliberately, remember that there are a number of things that must be configured correctly to allow your PC to communicate with the Vega:

1. Ensure that the Vega and the PC are connected via a crossover cable or via a standalone hub
  - so that neither the Vega nor the PC are served an IP address by a DHCP server
2. Ensure that the PC you are using has an APIPA address
  - from a DOS command prompt type 'ipconfig'
  - if the PC is configured for DHCP, ensure that it is powered up or rebooted whilst connected directly to the Vega – without access to a DHCP server (as per item 1) otherwise it may retain a previously acquired IP address.
3. The PC and the Vega only get APIPA interoperable IP addresses after timeouts indicate that the DHCP server is not available
  - it will take around 1 minute to decide that the DHCP server is not going to respond ... you need to wait at least this time before PC and Vega will set themselves up with APIPA interoperable IP addresses.
4. As the Vega must not have LAN 1 and LAN 2 interfaces in the same subnet, the Vega will only provide an APIPA interoperable IP address to LAN 1 – so use LAN 1 for initial connection
  - LAN 2 will get an APIPA interoperable IP only if LAN 1 has a valid, non APIPA interoperable, IP address.

### 3.1.2 DHCP Disabled

With `lan.if.x.use_dhcp=0`, the Vega uses the following locally configured items:

```
[lan.if.x]
  ip          The Vega's IP address
  subnet     LAN subnet mask

[dns.server.x]
  ip          Domain Name Server IP address

[lan.gateway]
  ip          Gateway (LAN router) IP address

[ntp]
  ip          Network Time Protocol server IP address

[tftp]
  ip          Trivial File Transfer Protocol server IP address
```

The `[lan.if.1.dhcp]` settings are ignored.

### 3.2 Finding Out The Vega's IP Address On An FXS Gateway

Vega FXS gateways allow you to determine the values of a number of IP parameters by lifting the handset of a telephone attached to the Vega and dialling #1#1.

Once #1#1 has been dialled a prompt will tell you that the Vega is waiting for a 3 digit command code to tell it which value you wish to listen to.

Valid command codes are:

- 101 to hear the IP address of the LAN gateway
- 111 to hear the IP address of LAN 1
- 112 to hear the subnet mask for LAN 1
- 121 to hear the IP address of LAN 2
- 122 to hear the subnet mask for LAN 2
- 131 to hear the IP address of the tftp server

The following parameters are relevant to configuring this feature:

New parameter added:

`voice_prompt.mode`

Possible values:

`read_only` - Default - Readback IP parameters when requested  
`off` - Disable readback of IP parameters

## 4 DUAL BOOT H.323 / SIP

### 4.1 Dual Boot Introduction

When the Vega is first powered up after delivery from VegaStream, the user is asked to select either H.323 or SIP operation. The choice made will select the code to be run at all subsequent boots (no further prompts will be made to select the code to run). If a change is subsequently desired then both the CLI and www interfaces allow the code to be changed.

The first time the *admin* user logs into either a Telnet or RS-232 serial interface or the www browser interface they will be presented with the choice of SIP or H.323 code. (Before this choice has been made the Vega will not respond to calls on either the LAN or telephony interfaces).

***For full details on selection of H.323 or SIP at initial boot time and afterwards, see Information Note "IN 05 – SIP\_H323 Dual boot operation"***

### 4.2 Boot manager and Autoexec interaction

If the autoexec feature (see section 19) is used to load firmware and configuration parameters then this will be used in preference to the boot manager for selecting the required code – no manual intervention will be required.

## 5 USER INTERFACES

Vega products support both a web browser interface and a command line interface. The web browser interface allows the user to configure and manage the Vega in most situations. The command line interface supports all the functionality of the web browser interface plus some additional functionality – though typically the extensions are only required for advanced configuration.

Default username and passwords are as follows:

Username: admin

Password: admin

### 5.1 Command Line Interface (CLI)

There are three mechanisms for accessing the CLI on the Vega:

- Serial Connection
- Telnet Connection
- Via Web Interface

After successful entry of the username and password, the Vega provides a command prompt. Each command can be typed directly into the interface and edited using the backspace (^H) key. The other control characters supported are carriage return (^M) and line feed (^J). The command history can be reviewed and executed by using the Up and Down arrows.

#### 5.1.1 Serial Connection

This uses the the built-in Serial (RS-232) port. Plug a serial cable from the RJ-45 connector labelled “Console” on the rear of the Vega to your computer’s serial port. Configure a serial terminal emulator program (like Microsoft’s HyperTerminal) with the following parameters, these are the default values used by Vega gateways:

```
Baud Rate: 115200 bps
Data: 8 bits
Parity: None
Stop: 1 bit
```

Press the enter key to see the login screen.

It’s also possible to change the characteristics of the serial connection using the following parameters:

Parameter:

```
rs232.x.baud_rate
```

Possible Values:

```
115200 - Default - Use baud rate of 115200bps
9600 / 19200 / 38400 / 57600 - Use specified baud rate
```

Parameter:

```
rs232.x.data_bits=8
```

Possible Value:

```
8 - Default - Fixed at 8 data bits
```

Parameter:

```
rs232.x.flow_control=xonxoff
```

Possible Values:

```
none - Default - Do not use flow control
xonxoff - use xon, xoff control characters for flow control
hardware - use hardware based flow control
```

Parameter:



```
rs232.x.parity=none
```

**Possible Values:**

```
none - Default - Do not use parity bit  
odd / even / mark / space - Use the specified parity check
```

**Parameter:**

```
rs232.x.stop_bits=1
```

**Possible Values:**

```
1 - Default - Use time equal to 1 bit for stop bit  
1.5 / 2 - Use specified time
```

### 5.1.2 Telnet Connection

Connect the PC and Vega to a LAN and then using a telnet program connect to the Vega's IP address `lan.if.x.ip` (see Chapter 3). Immediately the connection is made the login screen will be displayed.

By default telnet sessions connect via the standard well known telnet IP port number 23. If required, this value can be changed in parameter:

```
telnet.port=x
```

### 5.1.3 Web Interface

To access the command line interface via the web browser, log on to the web browser interface and type the CLI command in the CLI window which can be found on the [Advanced](#) page, then select push the "Submit" button:



The image shows a web interface element for entering CLI commands. It consists of a blue header bar with the text "CLI Command" in white. Below the header is a white text input field with a thin border. To the right of the input field is a grey button with the word "Submit" in black text.

## 5.2 Configuration/Management command summary

All commands are available through the CLI interface and they are listed in **Table 1**.

In the table, UPPER CASE is a convention used to mean literal text to be typed (but all commands and parameters are not case sensitive), lower case text refers to a tag or parameter.

The H.323 and SIP columns indicate whether the command is applicable to H.323 and / or SIP code.

Table 1 - Regular Commands					
H 3 2 3	S I P	Command	Parameter 1	Parameter 2	Comments
✓	✓	<b>APPLY</b>			activate all changed parameters that are "APPLY-able"
✓	✓	<b>BILL</b>	OFF ON Z CLEAR		turn billing to internal buffer off turn billing to internal buffer on for calls with duration >0 turn billing to internal buffer on for <i>all</i> calls (duration >=0) clear billing log
✓	✓	<b>BILL DISPLAY</b>	OFF ON		turn billing display to screen (from buffer) off turn billing display to screen (from buffer) on
✓	✓	<b>BLOCK CALLS</b>			block new calls
✓	✓	<b>BOOT MANAGER</b>			enter boot manager menu (to change firmware partition)
✓	✓	<b>CAP</b>	File TFTP:file FTP:file	command	redirect command output to named file on TFTP/FTP server redirect command output to named file on TFTP server redirect command output to named file on FTP server
✓	✓	<b>CD</b>	path		change current configuration path to path
✓	✓	<b>CLEAR STATS</b>			Clear entity statistics
✓	✓	<b>CP</b>	path		change current configuration path to path
✓	✓	<b>DELAY</b>	timeout		wait a specified number of milliseconds (useful for scripts)
✓	✓	<b>DELETE</b>	path		delete the last entry in the configuration list given by path
✓	✓	<b>DELETE</b>	path	index	delete the given entry in the configuration list given by path.index
✓	✓	<b>DISC</b>	index		disconnect call with ID "index" (see <a href="#">SHOW TRACE</a> )
✓	✓	<b>DISC ALL</b>			disconnect all active calls
✓	✓	<b>DUMP LOG</b>	Cref in	cref out	dump system log & settings
✓	✓	<b>e1t1</b>	bypass	off	If e1t1.bypass_mode is set to manual, 'e1t1 bypass off' will switch the calls to be routed to the Vega (remove any bypass)  For further details, see IN_44-Vega_400_ByPass_relays on the technical documents page of <a href="http://www.VegaAssist.com">www.VegaAssist.com</a>
✓	✓	<b>e1t1</b>	bypass	on	If e1t1.bypass_mode is set to manual, 'e1t1 bypass on' will switch the calls to be routed to the ByPass connectors - Vega will no longer handle telephony calls  For further details, see IN_44-Vega_400_ByPass_relays on the technical documents page of <a href="http://www.VegaAssist.com">www.VegaAssist.com</a>
✓	✓	<b>EXIT</b>			exit command line (logout)

Table 1 - Regular Commands					
H 3 2 3	S I P	Command	Parameter 1	Parameter 2	Comments
✓	✓	<b>FACTORY RESET</b>			reset config to factory defaults (excludes certain parameters like lan.if.x.ip – see table in section 6.7; entries marked with a P are preserved through a factory reset)
✓		<b>GATEKEEPER</b>	STATUS REGISTER UNREGIST ER REREGIST ER		gatekeeper registration control / status
✓	✓	<b>GET</b>	File  TFTP:file  FTP:file		read command file from TFTP/FTP server and execute commands to the console  read command file from TFTP server and execute commands to the console  read command file from FTP server and execute commands to the console
✓	✓	<b>HELP</b>			display (this) help message
✓	✓	<b>HELP</b>	command		display help on specified command
✓	✓	<b>HELP</b>	ADVANCE D		display advanced commands help message
✓	✓	<b>KILL</b>	Session  ALL		Kills a specific or ALL Telnet, web browser and serial interface sessions. To find the session value – see <a href="#">“show ports”</a>  [Neither variant of this command will kill the session initiating the request]  [Even though killed, web sessions will remain listed until there is web browser activity, at which point the list is updated]
✓	✓	<b>LOG</b>	OFF ON I A W F E X CLEAR		turn Vega event logging off turn Vega event logging on include all log (Information & above) messages in log buffer include all alerts and above in log buffer include all warnings and above in log buffer include all failures and above in log buffer include all errors and above in log buffer include only fatal errors in log buffer clear event log buffer
✓	✓	<b>LOG DISPLAY</b>	OFF ON I A W F E X		turn Vega event log message display off turn Vega event log message display on (subject to <a href="#">Log on</a> ) display all types of log messages display alert and above messages display warning and above messages display failure and above messages display error and above messages display only fatal error messages
✓	✓	<b>NEW</b>	path		create a new configuration list entry
✓	✓	<b>PASSWORD</b>			change a user's password

Table 1 - Regular Commands					
H 3 2 3	S I P	Command	Parameter 1	Parameter 2	Comments
✓	✓	<b>PING</b>	IP/host		ping an IP host
✓	✓	<b>PLAN</b>	number		set dial plan path to specified plan entry
✓	✓	<b>POST PROFILE</b>	number		set path to planner.post_profile.n
✓	✓	<b>PROFILE</b>	number		Set path to planner.profile.n
✓	✓	<b>PURGE</b>	path		delete all except the first entry in the configuration list given by path
✓	✓	<b>PUT</b>	File  TFTP:file  FTP:file	sect	write user configuration section sect to TFTP/FTP server as a command file  write user configuration section sect to TFTP server as a command file  write user configuration section sect to FTP server as a command file
✓	✓	<b>QOS CLEAR</b>			Empty the QOS records buffer
✓	✓	<b>QOS REPORT</b>	ON OF		Enable / disable QOS stats to this terminal
✓	✓	<b>REBOOT SYSTEM</b>			reboot system immediately
✓	✓	<b>SAVE</b>			save changed parameters for next reboot
✓	✓	<b>SET</b>	string1	string2	set an existing config entry named string1 to string2
✓	✓	<b>SET DATE</b>	digits		change current date digits = ddmmyy[yy]
✓	✓	<b>SET TIME</b>	digits		change current time digits = hhmmss (24hr clock format)
✓	✓	<b>SHOUT</b>	message		Displays the 'message' to all users logged in on telnet, ssh or serial interfaces.
✓	✓	<b>SHOW</b>	string		show configuration entry (parameter) named string
✓	✓	<b>SHOW</b>	string	<b>STATUS</b>	list parameters (under path <i>string</i> ) whose value is different from their default or saved value, indicating whether they are different from the factory default value and indicating if they are different from their saved value.  If string = <b>ALL</b> then all parameters, including the <i>_advanced</i> parameters will be included
✓	✓	<b>SHOW</b>	string	<b>5.2.1.1.1.1.1</b>	as show status, but also displaying the factory and/or saved values  If string = <b>ALL</b> then all parameters, including the <i>_advanced</i> parameters will be included
✓	✓	<b>SHOW</b>	string	<b>VERBOSE</b>	as show changes, but with non-changed parameters also being listed  If string = <b>ALL</b> then all parameters, including the <i>_advanced</i> parameters will be included
✓	✓	<b>SHOW ARP</b>			show ARP table
✓	✓	<b>SHOW BANNER</b>			show system identification information
✓	✓	<b>SHOW BILL</b>			show billing log summary
✓	✓	<b>SHOW CALLS</b>			show call summary table
✓	✓	<b>SHOW CHECKSUM</b>			show firmware checksum
✓	✓	<b>SHOW DSP</b>			Show dsp / codec configuration parameters

Table 1 - Regular Commands					
H 3 2 3	S I P	Command	Parameter 1	Parameter 2	Comments
					... see also status terms
✓	✓	<b>SHOW FIXED TONES</b>			Show fixed tones table.
✓	✓	<b>SHOW GROUPS</b>			Show dial plans by group
✓	✓	<b>SHOW GROUPS</b>	interface		Show dial plans by group for the specified interface
✓	✓	<b>SHOW HOSTS</b>			show local host table contents
✓	✓	<b>SHOW LANCFG</b>	all ftp tftp dns ntp		Shows ip configuration information for various devices - choosing a device specifically gives more information than that displayed using 'all'
✓	✓	<b>SHOW LAN ROUTES</b>			show LAN routing information
✓	✓	<b>SHOW LOG</b>			show event log buffer
✓	✓	<b>SHOW PATHS</b>	interface		show dialling plan contents per port in priority order
✓	✓	<b>SHOW PLAN</b>			show dialling plan entries in entry order
✓	✓	<b>SHOW PORTS</b>			show active port summary table
✓	✓	<b>SHOW POST PATHS</b>			show dialling plan post_profile contents per port in priority order
✓	✓	<b>SHOW QOS</b>	CDR CDR LAST STATS STATS LAST		Display all per-call QOS CDRs from buffer Display latest per-call QOS CDR fromn the buffer Calculate and display Gateway statistics Display last calculated gateway statistics
✓	✓	<b>SHOW SUPPORT</b>			Show logs and statistics that are useful for support purposes
✓	✓	<b>SHOW STATS</b>			show system memory, network, and task staistics
✓	✓	<b>SHOW SYSLOG</b>			show Syslog settings and status
✓	✓	<b>SHOW TIME</b>			show current time and date
✓	✓	<b>SHOW TRACE</b>			show trace information about calls in progress, giving call index numbers for each active call
✓	✓	<b>SHOW VERSION</b>			show Vega version and hardware information
✓	✓	<b>SHUTDOWN SYSTEM</b>			shut down all calls and communication functions
	✓	<b>SIP MONITOR</b>	ON		Turn on SIP message display onto console
			OFF	n	Turn off SIP message display
	✓	<b>SIPROXY</b>	SHOW REG KILL REG		Shows cached registration information held in the resilience proxy Kills the cached registration entry n
	✓	<b>SIP SHOW REG</b>	[user]		Show registration status for SIP users – no parameter is an implicit ALL; specifying a user limits the display to that user's registration status.
	✓	<b>SIP REG</b>	User		Register the user "User"

Table 1 - Regular Commands					
H 3 2 3	S I P	Command	Parameter 1	Parameter 2	Comments
			ALL		Register all users
	✓	<b>SIP CANCEL REG</b>	User ALL		Un-register the user "User" Un-register all users
	✓	<b>SIP RESET REG</b>			Un-registers then re-registers all users
✓	✓	<b>STATUS SOCKETS</b>			Show the status of the Vega's LAN socket connections
		<b>STATUS TERMS</b>			Shows how the media layer is configured to handle audio; shows both the RTP (LAN) and TDM (telephony) configurations for all calls in progress ... see also showdsp
✓	✓	<b>SYNC TIME</b>			read time and date from NTP time server
✓	✓	<b>TCAP</b>	file	command	redirect command output to named TFTP file (see also CAP)
✓	✓	<b>TGET</b>	file		read command file from TFTP server and execute commands to the console (GET command is preferred)
✓	✓	<b>TPUT</b>	file	sect	write user configuration section sect to TFTP server as a command file (PUT command is preferred)
✓	✓	<b>TRY</b>	address		test the dial planner with a sample address
✓	✓	<b>UNBLOCK CALLS</b>			unblock new calls
✓	✓	<b>UPGRADE</b>			enter system upgrade menu
✓	✓	<b>WARNINGS</b>			Show a list of warnings that have been observed by the Vega. These should be addressed if the Vega is not working as expected.

<b>Table 2 - Diagnostics Commands</b>					
<b>NOTE:</b> Only to be used under the direction of your supplier; these commands can affect the call handling capability of your Vega.					
H 3 2 3	S I P	Command	Parameter 1	Parameter 2	Comments
✓	✓	<b>DEBUG</b>	OFF ON WATCHON  WATCHOFF LIST INC EXC SAVE STOP MEMORY DUMP FOLLOW		diagnostic debug trace commands  - watchdog on (default state) reboots Vega if code does not reset the watchdog timer regularly - watchdog off - list current settings - “inclusive” (trace if either the entity or the module is executing) - “excluding” (trace only if entity AND module are running) - Saves current diagnostics settings to RAM – survives reboot but not power down / up - Stop sending debug information to memory – often used before DUMP - Diagnostics dumped to memory instead of the terminal – less load on the Vega - Dump debug from memory to terminal
✓	✓	<b>DEBUG</b>	ENABLE DISABLE	dparms <sup>1</sup>	enable / disable trace levels
✓	✓	<b>DEBUG CONTENT</b>	Name	options <sup>2</sup>	set the content level for diagnostics
✓	✓	<b>DEBUG DSP</b>	ON OFF STOP RESET DUMP		enable / disable / stop / reset / dump DSP log (log = trace of ALL packets in both directions between the MIPS processor and the DSP)
✓	✓	<b>DIAGS</b>			logout and enter the diagnostics menu (RS-232 console only)  For engineering use only, do not use this function unless directed by your supplier
✓	✓	<b>DISP</b>	X	Y <string>	Display the string on the LCD at position X,Y

<sup>1</sup> Details about dparms are provide when required by technical support personnel – some information is also available on the VegaStream Support web site.

<sup>2</sup> Details about options are provide when required by technical support personnel – some information is also available on the VegaStream Support web site.

<b>Table 2 - Diagnostics Commands</b>					
<b>NOTE:</b> Only to be used under the direction of your supplier; these commands can affect the call handling capability of your Vega.					
H 3 2 3	S I P	Command	Parameter 1	Parameter 2	Comments
✓	✓	<b>DSLRR</b>	dsl	reg	Read a register on a DSL  1xx = SIGX, 2xx= RPSC registers, 3xx=TPSC registers
✓	✓	<b>DSLWR</b>	dsl	reg value	Write a register on a DSL  1xx = SIGX, 2xx= RPSC registers, 3xx=TPSC registers
✓	✓	<b>DSPDIAG</b>	RAW VSTATS ERROR RXTX LEVELS FMSTATS FSTATS FCSTATS VALL FALL	chan	Send a diagnostic command to a specific DSP channel. (Use <a href="#">SHOWDSP</a> to get the DSP channel number)
✓	✓	<b>FAC</b>	ix	data	Send a FACILITY message with nonStandardData to the H.323 endpoint in ROUTE ix
✓	✓	<b>HANDLE</b>	handle	level recurse	Display Handle information
✓	✓	<b>HDUMP</b>			Display all Busy Handles information
✓	✓	<b>HIGHWAY CHECK</b>			Checks the status of the cross point switch
✓	✓	<b>HIGHWAY CHECK</b>	ALL		Checks the status of the cross point switch and displays the crosspoint information
✓	✓	<b>HLIST</b>	type	level recurse	Display Busy Handles information
	✓	<b>QUICK</b>	APPLY  TEST		Activate Quick config parameters – map them to normal parameters and Apply the result  Test what differences there are between the current config and that that would be set if QUICK APPLY were executed
✓		<b>RAD</b>	OFF ON LEVEL ADD DELETE SHOW STATS		control H.323 logging (requires debug on)
✓	✓	<b>SHOWDSP</b>			display the status of all DSP channels, and codec capabilities
✓	✓	<b>SHOWDSP</b>	channel		display the status of a specific DSP channel



<b>Table 2 - Diagnostics Commands</b>					
<b>NOTE:</b> Only to be used under the direction of your supplier; these commands can affect the call handling capability of your Vega.					
H 3 2 3	S I P	Command	Parameter 1	Parameter 2	Comments
✓	✓	<b>TCS</b>	call	NORMAL EMPTY	Send TCS for specified call
✓	✓	<b>TESTDSP</b>	test		

### 5.3 Web Browser Interface

The web browser interface is accessed by entering the IP address of the Vega into the "Address" field of the web browser as indicated below:

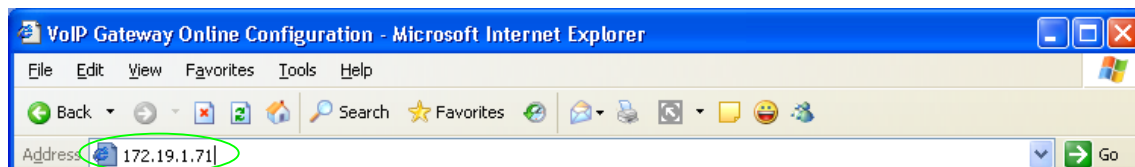

You will then be presented with the login page:

 A screenshot of a web-based login page. The page has a title "Login" and a sub-header "Enter Username and Password". Below this, there are two input fields: "Username" and "Password". Both input fields are circled in green. At the bottom of the form is a "Login" button.

Enter the Username and Password, then select "Login"

Default username and password is as follows:

Username: admin

Password: admin

For information on configuring Vega gateways using the web browser interface, see the initial configuration guides for the Vegas – available in the 'step-by-step configuration' section of the VegaStream support web site ([www.VegaAssist.com](http://www.VegaAssist.com)).

### 5.4 Disabling remote user interface access

Remote access to the Vega (access through the web and telnet interfaces) can be disabled through use of the Command Line Interface parameters:

```
users.admin.remote_access=0/1
users.billing.remote_access=0/1
users.user.remote_access=0/1
```

0 = disable, 1 = enable.



**WARNING!**

**Disabling remote access to the Administrator user means that the only method of accessing the Vega to configure or manage it is through direct connection to its Serial interface – this can only be done locally.**

NOTE

Telnet access for the BILLING user is prevented until the billing user password has been changed from its default value.

## 5.5 TFTP and FTP

All Vega products support both TFTP and FTP for saving user configuration information to, and for retrieving information from a centralised server. By default file transfer commands use TFTP, but TFTP or FTP can be selected either by configuring a new default or by explicitly defining in the command whether to use TFTP or FTP.

FTP / FTTP instructions:

*Writing a config file:*

```
put myfile.txt [<section>] - use configured selection TFTP/FTP
put FTP:myfile.txt [<section>] - use FTP
put TFTP:myfile.txt [<section>] - use TFTP
tput myfile.txt [<section>] - use TFTP
```

*Reading a config file:*

```
get myfile.txt - use configured selection TFTP/FTP
get FTP:myfile.txt - use FTP
get TFTP:myfile.txt - use TFTP
tget myfile.txt - use TFTP
```

*Redirecting a command output to a file:*

```
cap myfile.txt <command> - use configured selection TFTP/FTP
cap FTP:myfile.txt <command> - use FTP
cap TFTP:myfile.txt <command> - use TFTP
tcap myfile.txt <command> - use TFTP
```

*Upgrading firmware:*

```
download firmware myfile.txt [<options>] - use configured selection TFTP/FTP
download firmware FTP:myfile.txt [<options>] - use FTP
download firmware TFTP:myfile.txt [<options>] - use TFTP
```

*Upgrading bootstrap code:*

```
download boot myfile.txt - use configured selection TFTP/FTP
download boot FTP:myfile.txt - use FTP
download boot TFTP:myfile.txt - use TFTP
```

*Upgrading ISDN code:*

```
download isdn myfile.txt - use configured selection TFTP/FTP
download isdn FTP:myfile.txt - use FTP
download isdn TFTP:myfile.txt - use TFTP
```

Where the FTP/TFTP is not defined explicitly, the value of the configuration parameter

```
[lan]
file_transfer_method
```

defines whether FTP or TFTP will be used.

### 5.5.1 Choosing the protocol

TFTP is the simpler of the two protocols. It is designed to work over short distances, it does not have extensive retries built in and does not require any passwords to be configured.

FTP on the other hand is designed to work over longer distances; retries are integral to the protocol transport layer, so even if packets are lost or discarded in the network they get re-sent so that there is no resultant loss of data.

As far as password security is concerned, FTP clients and servers can work in two modes, i) an “anonymous” mode where no password validation is required, and ii) “password required” mode where a username and password are used.

For short distances both tftp and ftp provide a reliable means of transferring data into or out of the Vega. If longer distances (e.g. across a country) need to be covered, or security is an issue, then ftp is a better option.

### 5.5.2 Configuring TFTP

To use tftp, ensure that there is a tftp server that can be accessed, then configure the Vega parameters as follows:

```
[tftp]
  ip = <ip address of the tftp server>
```

optionally configure:

```
[lan]
  file_transfer_method=tftp
[tftp]
  tftp_ping_test=1 or 0
```

Now use the commands PUT, GET CAP or DOWNLOAD in one of the three forms:

```
put <filename>
tput <filename>
put TFTP:<filename>
```

### 5.5.3 Configuring FTP

To use ftp, ensure that there is an ftp server that can be accessed, then configure the Vega parameters as follows:

```
[ftp]
  ip = <ip address of the tftp server>
```

optionally configure:

```
[lan]
  file_transfer_method=tftp
[ftp]
  tftp_ping_test=1 or 0
```

If no password authentication is required then set:

```
[ftp]
  anonymous_login=1
```

If password authentication is required then set:

```
[ftp]
anonymous_login=0
username=<username>
_password=<password>
timeout=<timeout>
```

Now use the commands PUT, GET CAP or DOWNLOAD in one of the two forms:

```
put <filename>
```

```
put FTP:<filename>
```

NOTE

The Vega uses ASCII transfer mode FTP for PUT, GET, CAP and Download

## 6 SYSTEM CONFIGURATION DATABASE

### 6.1 Configuration Storage and Layout

The system configuration database contains all the Vega configuration parameters; it is held within the Vega gateway memory. The configuration is broken down into a number of sections. Each section has a name, as do all parameters within each section. There are four versions of the configuration within the unit:

- 1) *Factory configuration – in program memory*  
Contains factory defaults that are specific to a particular firmware version.
- 2) *Saved configuration*  
Contains the last saved user configuration and is changed using the SAVE and FACTORY RESET commands only.
- 3) *User configuration*  
At boot time this memory is loaded with the last saved configuration entries. This area can be viewed and changed directly using the command line interface commands CP, SHOW, SET, NEW, DELETE, FACTORY RESET, and GET commands, also indirectly using the PC web browser.
- 4) *Runtime configuration*  
At boot time (power on or after a 'reboot system') this memory is loaded with the last saved configuration entries. The Vega runtime code uses these configuration values to define how the unit operates. The show plan command allows vision of the runtime dial plan entries. Certain parameters – like the dial plan - can be updated from values stored in the user configuration memory using the APPLY command.

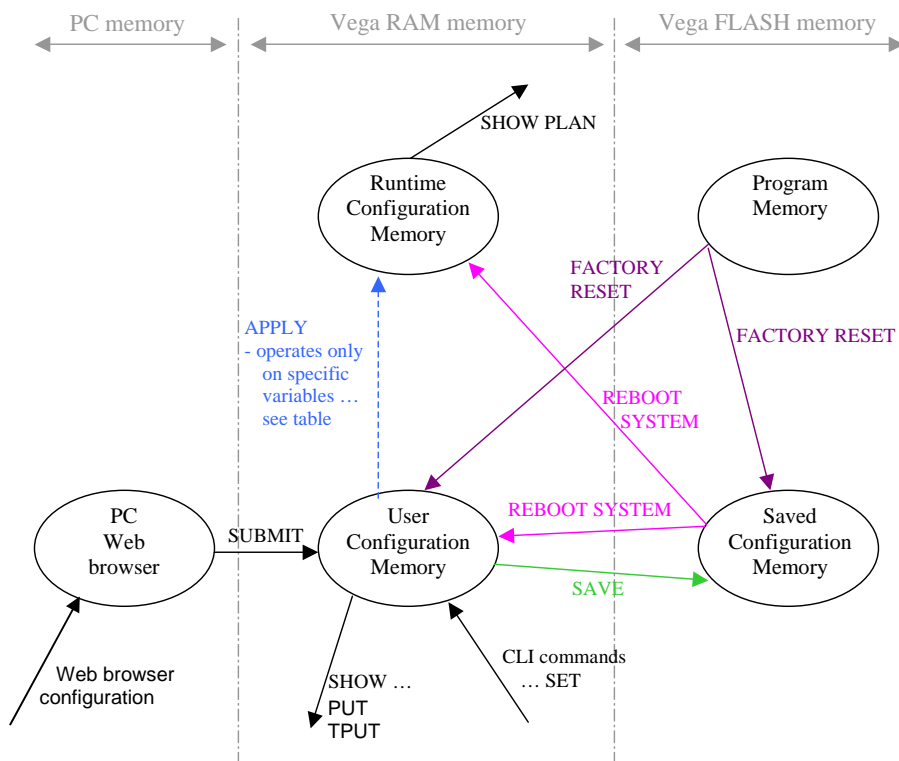

Only parameters in the user configuration memory can be viewed directly in their raw stored form. When information is displayed from the run time memory, for example using commands

like `SHOW PLAN` and `SHOW PATHS`, a processed version of the data is displayed. There are no commands to display the contents of program memory or saved configuration memory.

When using the Web browser to configure the Vega, there is another set of memory that must be considered – the PC memory. When changes are made to the screen contents on the web browser the changes are only made in the PC memory – these changes are sent to the Vega when the “Submit” button associated with the changed section on the browser page is pressed.

## 6.2 Saving And Resetting Configuration Data

The following commands can be used to copy configuration data from one config area to another:

<code>SAVE</code>	copies configuration data from user configuration to saved configuration
<code>FACTORY RESET</code>	copies configuration data from factory defaults into user configuration and saved configuration

### NOTE

Certain parameters like `lan.if.x.ip` are not overwritten by the `FACTORY RESET` copy – see the table in section 6.7; entries marked with a P are preserved through a factory reset



### WARNING!

**Use with caution; FACTORY RESET will overwrite most parameters with preset factory default values.**

## 6.3 Displaying Configuration Values

### 6.3.1 Displaying Values Using The Command Line Interface

In the CLI each parameter has a configuration path used to access it. This is made up of all the corresponding section names plus the parameter name itself specified using the dot character between each, e.g. the parameter 'ip' within the subsection 'gateway', within section 'lan' is referred to as:

```
lan.gateway.ip
```

The command `CP` is used to navigate through the runtime configuration and the `SHOW` command is used to view entries or entire sections, e.g. the following commands can be used to show the parameter '`elt1.port.1.clock_master`':

```
admin > show elt1.port.1.clock_master
admin > show .elt1.port.1.clock_master
admin > cp elt1.port.1
admin elt1.port.1 > show clock_master
```

Note that all paths beginning with '.' are absolute paths. All paths beginning without '.' are relative to the last path change typed using `CP`.

### 6.3.1.1 Show

All sections displayed using `SHOW` or `SHOW <section>` will display the section and any sub-sections below that section. If the section name is followed by a '.' character then only that section will be displayed. For example, to display all LAN parameters:

```
admin >show lan
[lan]
  dns=0.0.0.0
  gateway=10.0.0.1
  ip=200.100.50.25
  name=Vega100
  ntp=0.0.0.0
  ntp_local_offset=0000
  ntp_poll_interval=0
  subnet=255.255.255.0
  tftp=0.0.0.0
  use_dhcp=0
[lan.localDNS.1]
  ip=127.0.0.1
  name=loopback
[lan.phy]
  full_duplex=0
  10baset=1
  100basetx=1
```

And to display only parameters in the top LAN section:

```
admin >show lan.
[lan]
  dns=0.0.0.0
  gateway=10.0.0.1
  ip=200.100.50.25
  name=Vega100
  ntp=0.0.0.0
  ntp_local_offset=0000
  ntp_poll_interval=0
  subnet=255.255.255.0
  tftp=0.0.0.0
  use_dhcp=0
```

### 6.3.1.2 Show status

`SHOW STATUS` or `SHOW <section> STATUS` will display a list of parameters, within the section and any sub-sections below that section, which are different to their default or saved



values. It also indicates against each entry whether it is different from the factory default value and/or the saved value.

SHOW ALL STATUS performs a SHOW STATUS followed by SHOW \_advanced STATUS, so the output consists of 2 sets of results.

For example:

```
admin >show lan status
```

Configuration changes:

Key: CU: Changed from factory and unsaved.  
 C-: Changed from factory and saved.  
 -U: Not changed but unsaved.

```
[lan]
  CU dns=136.170.208.4
  -U ftp=0.0.0.0
  CU gateway=136.170.208.1
  CU ip=136.170.209.248
  CU ntp=136.170.144.18
  CU subnet=255.255.254.0
  CU tftp=136.170.209.228
  CU use_dhcp=0
```

```
[lan.dhcp]
  -U get_gateway=1
```

```
[lan.localDNS.2]
  C- name=new_host
```

```
[lan.localDNS.3]
  C- ip=0.0.0.0
  C- name=new_host
```

```
Total changed: 10 Unsaved: 9
```

### 6.3.1.3 Show changes

SHOW CHANGES or SHOW <section> CHANGES will display a list of parameters, within the section and any sub-sections below that section, which are different to their default or saved values. It also indicates against each entry whether it is different from the factory default value and/or the saved value; factory and/or saved values are displayed where they are different.

SHOW ALL CHANGES performs a SHOW CHANGES followed by SHOW \_advanced CHANGES, so the output consists of 2 sets of results.

For example:

```
admin >show lan changes
```

Configuration changes:

```
Key: CU: Changed from factory and unsaved.
     C-: Changed from factory and saved.
     -U: Not changed but unsaved.
```

```
[lan]
CU dns=136.170.208.4
    *factory=0.0.0.0
-U ftp=0.0.0.0
    *saved=136.170.208.123
CU gateway=136.170.208.1
    *factory=0.0.0.0
    *saved=0.0.0.0
CU ip=136.170.209.248
    *factory=0.0.0.0
    *saved=136.170.208.204
CU ntp=136.170.144.18
    *factory=0.0.0.0
CU subnet=255.255.254.0
    *factory=255.255.255.0
CU tftp=136.170.209.228
    *factory=0.0.0.0
    *saved=136.170.209.248
CU use_dhcp=0
    *factory=1
    *saved=1
```

```
[lan.dhcp]
-U get_gateway=1
    *saved=0
```

```
[lan.localDNS.2]
C- ip=0.0.0.0
    *factory=New entry
C- name=new_host
    *factory=New entry
```

```
[lan.localDNS.3]
C- ip=0.0.0.0
    *factory=New entry
C- name=new_host
    *factory=New entry
```

```
Total changed: 11 Unsaved: 9
```

#### 6.3.1.4 Show verbose

SHOW VERBOSE or SHOW <section> VERBOSE will display a list of all parameters within the section and any sub-sections below that section. For those that are different to their default or saved values the listing will indicate which value they are different to, and will list the value of the factory default and/or saved value, whichever is/are different.

SHOW ALL VERBOSE performs a SHOW VERBOSE followed by SHOW \_advanced VERBOSE, so the output consists of 2 sets of results.

For example:

```
admin >show lan. verbose
```

Configuration changes:

Key: CU: Changed from factory and unsaved.  
C-: Changed from factory and saved.  
-U: Not changed but unsaved.

```
[lan]
CU dns=136.170.208.4
    *factory=0.0.0.0
-U ftp=0.0.0.0
    *saved=136.170.208.123
CU gateway=136.170.208.1
    *factory=0.0.0.0
    *saved=0.0.0.0
CU ip=136.170.209.248
    *factory=0.0.0.0
    *saved=136.170.208.204
    name=Vega100T1E1
CU ntp=136.170.144.18
    *factory=0.0.0.0
    ntp_local_offset=0000
    ntp_poll_interval=0
CU subnet=255.255.254.0
    *factory=255.255.255.0
CU tftp=136.170.209.228
    *factory=0.0.0.0
    *saved=136.170.209.248
CU use_dhcp=0
    *factory=1
    *saved=1
```

Total changed: 11 Unsaved: 9

## 6.4 Changing Configuration Values

### 6.4.1 Changing Configuration Values Using The Web Browser

In the web browser, configuration values have been grouped together into appropriate pages – values are changed by entering the new value into the appropriate text box, selecting the required value using a combo selector, or selecting the right value using a radio button selector.

Once the desired value has been specified press the “Submit” button to send the information to the user configuration memory in the Vega.

### 6.4.2 Changing Configuration Values Using The Command Line Interface

The commands SET, NEW, PURGE, DELETE, GET and FACTORY RESET can be used to change the user configuration.

SET changes an existing parameter value.

```
admin > set path.parameter=value
```

Multiple parameters can be set using the same command, separating entries with spaces,

```
admin > set path.parameter=value path.parameter2=value2 etc.
```

To get help on the range of possible values to use for a specific parameter type:

```
SET <path.parameter>=?
```

e.g. to set the host name:

```
admin >set lan.name=test
[lan].name=test
```

e.g. to set the host name and the tftp address

```
admin >set lan.name=test lan.tftp=192.168.1.108
[lan].name=test
[lan].tftp=192.168.1.108
```

e.g. to retrieve help on the syntax

```
admin >set lan.name=?
entry      : lan.name
expecting: string of between 1 and 31 characters
```

#### NOTE

If you have a number of different parameters to change in a specific path, or a long path to type in, instead of typing in the full path each time use `cp path` to get to the desired place then use the sub path from here to the parameter, or if the Vega is now in the parameter's path just use `set parameter=value`

e.g.:

```
cp.lan
set name=test ; configures lan.name
```

## 6.5 Manipulating List Sections

A list section contains 1 or more numbered subsections. Each subsection contains the same set of configurable parameters. Lists are used where either i) a variable number of sets of entries need to be defined (e.g. `lan.localDNS` entries) or ii) a number of sets of parameters can be configured and the Vega selects the appropriate set through configuration of another parameter (e.g. `serviceprofile` and `qos_profile`).

### 6.5.1 Manipulating List Sections using the web browser

Where required the “Add” and “Delete” buttons are provided to add or delete entries from lists. When add is used, the list section added is initialised to default values which can then be overwritten to the desired values.

### 6.5.2 Manipulating List sections using the Command Line Interface

The command `NEW <path>` (or the command `NEW` from within the list structure) adds a new numbered record to the list section, initialising it with default values. The command `SET` can then be used to override these default values with new ones. E.g. to check the `lan.localDNS` table, then add a new entry to the LAN localDNS table and configure its 2 parameters using a single `SET` command:

```
admin >show lan.localDNS
[lan.localDNS.1]
  ip=127.0.0.1
  name=loopback

admin >new lan.localDNS
admin lan.localDNS.2 >show
[lan.localDNS.2]
  ip=0.0.0.0
  name=new_host
admin lan.localDNS.2 >set ip=1.2.3.4 name=test
[lan.localDNS.2].ip=1.2.3.4
[lan.localDNS.2].name=test
```

`DELETE` removes either the last record from a list section, or the specified record, e.g. to remove the last entry:

```
admin lan.localDNS.2 > cp .
admin >delete lan.localDNS 2

Delete OK
admin >show lan.localDNS
[lan.localDNS.1]
  ip=127.0.0.1
  name=loopback
```

`PURGE` removes all records in a particular list section, leaving just the first record (which must always be there). This can be used to ‘clean’ sections to a known state prior to restoring data.

## 6.6 Activating Configuration Changes

Changes to the configuration parameters are activated (ie are used by the running system) at different times depending on the type of parameter. Each entry falls into one of the following categories:

S/R	Effective after SAVE and REBOOT SYSTEM only
APPLY	Effective after APPLY
CALL	Effective on next call
IMM	Effective immediately
LOG	Effective after log out/log in

NOTE
------

- 1) On the web browser interface the "Submit" or "Apply" button must be pressed first to send the data to the Vega.
- 2) Entries activated after APPLY, CALL, IMM or LOG are not automatically saved in the non-volatile portion of the database. The SAVE command must still be used.

The activation category that each parameter is associated with has, where possible, been chosen according to the parameter's use; for example, DSP parameters are effective on next CALL so you can hear the difference when making small changes.

Typically major changes are only effective after a reboot.

## 6.7 Configuration Entries

The following table lists the configuration entries by section. Some of the section headers and parameters are hyperlinked – selecting them will take you to a section discussing the use of these parameters.

The activate column denotes when the change will take effect (for definition see chapter 6.6).

Key to symbols:

Activate field: P = Preserved through a factory reset

FXS/EXO	BRI	E/T1	H323	SIP	Section/Parameter	Activate	Range	Comments
					[bri]			
	✓		✓	✓	topology=s0	S/R	s0	Network topology or card type
					[bri.port.1]			
	✓		✓	✓	<a href="#">bus_master_priority</a> =1	APPLY	0 to 4	Preference level for synchronising the internal clock to this port, 1 = highest priority, 4 = lowest, 0 = don't use this port
	✓		✓	✓	enable=1	APPLY	0 or 1	0 = Do not enable this link 1 = Enable this link
	✓		✓	✓	framing=s_t	S/R	s_t/auto	Framing, auto = s_t
	✓		✓	✓	line_encoding=azi	S/R	azi/ auto	Line encoging, auto=azi <sup>3</sup>
	✓		✓	✓	<a href="#">line_type</a> =pmp		pmp or pp	Line type can be either Point-to-Multipoint or Point-to-Point
	✓		✓	✓	lyr1=auto	APPLY	G711Alaw64k/ g711Ulaw64k/ auto	A-law or u-law companding (G.711Alaw64k/G.711Ulaw64k) on the BRI LINK auto=g711Alaw64k
	✓		✓	✓	network=etsi	S/R	etsi	Network type.
	✓		✓	✓	nt=0	APPLY	0 or 1	0=TE, 1=NT;
	✓		✓	✓	nt_phantom_power=0		0 or 1	1= Provide power to BRI interfaces which are configured as NT (designed to power ISDN phone handsets, and sometimes used as a connection signal to ISDN PBXs)
	✓		✓	✓	restart_l2_after_disc=0			0 = re-establish layer 2 only if layer 1 is also down. 1 = force re-establishment of layer 2 if a layer 2 disconnect occurs.
	✓		✓	✓	<a href="#">tei</a> =0		0 to 63	For BRI, if the line is configured as Point-to-Point, tei defines the Terminal Endpoint Identifier - a static value of 0 to 63. Both ends must have the same value configured.  In BRI Point-to-Multi-Point this figure is not configurable but is negotiated (and will have a value in the range 64 to 126)
					[bri.port.1.group.1]			
	✓		✓	✓	<a href="#">alloc_chan</a> =default	S/R	default/ linear_up/ linear_down/ round_robin	Type of channel allocation strategy used (default = linear up if BRI LINK is NT and Linear down if BRI LINK is TE)
	✓		✓	✓	dn=*	S/R	Length<32	TE trunk: dn specifies the incoming telephone number that the trunk will respond to
	✓		✓	✓	<a href="#">first_chan</a> =1	S/R	1-2	First B-chan for this group
	✓		✓	✓	interface=0301	S/R	Length<32	Interface ID for this BRI LINK 0301 to 0308
	✓		✓	✓	<a href="#">last_chan</a> =2	S/R	1-2	Last B-chan for this group

<sup>3</sup> azi is the proper name for BRI line encoding on an S/T interface (hdb3 is the encoding used on the U interface)

FXS/FXO	BRI	E/T1	H 3 2 3	S I P	Section/Parameter	Activate	Range	Comments
	✓		✓	✓	tunnel_IEs_only=1		0 or 1	Tunnel specific information elements. IEs to tunnel are defined in <a href="#">_advanced.isdn.IEs_to_tunnel</a> .  N.B. Enable this parameter for both source AND destination trunks (for ISDN to ISDN tunnelling)  See table in section <a href="#">10.5.3 "Tunnelling full signalling messages and IEs in ISDN (ETSI, ATT, DMS, DMS-M1, NI, VN 3/4) and QSIG"</a> for details of interactions of various parameters with tunnel_IEs_only.
	✓		✓	✓	<a href="#">tunnel_mode</a> =on-demand	S/R	off/on-demand	Enable tunnelling, for full details see the table in section <a href="#">10.5.3 "Tunnelling full signalling messages and IEs in ISDN (ETSI, ATT, DMS, DMS-M1, NI, VN 3/4) and QSIG"</a>
					[bri.port.1.isdn]			<a href="#">ISDN</a> and <a href="#">QSIG</a> config
	✓		✓	✓	call_appearance=1		-254 .. 254	Configuration for US BRI (... when network=att_TE) - adds layer 3 Call appearance IE.  0: disabled  1 .. 254: Base value to use for the call appearance (uses a linear_up fill algorithm on a per port basis)  -1 .. -254: Use the positive value of this number for all outgoing calls on this BRI LINK - i.e. fixed call appearance value for all calls on this BRI LINK
	✓		✓	✓	chanid_excl=0	APPLY	0 or 1	Affects the 'preferred/exclusive' bit in the ISDN B-Channel Id Info Element of outbound ISDN calls 0 = 'preferred' 1 = 'exclusive' ... far end to drop call if this B-channel cannot be used
	✓		✓	✓	dtmf_dial_digit=#	APPLY	0 to 9, *, #, A to D, Z	DTMF dial termination character - the DTMF character that indicates that the dialled number is complete (overrides dtmf_dial_timeout) forcing the received number to be passed to the dial plan router (set to Z to disable this function)
	✓		✓	✓	dtmf_dial_timeout=5	APPLY	1-999	Time after last dialled digit is received that dialled number is forwarded to the dial plan router (in seconds)  999 = no timeout used
	✓		✓	✓	end_to_end_call_proceeding=0	APPLY	0,1	0 = Disabled 1 = Enabled, For ISDN to ISDN calls Vega will wait for incoming call proceeding message before transmitting call proceeding message on the originating ISDN link.
	✓		✓	✓	<a href="#">incoming_cause_mapping_index</a> =0	APPLY	Index	Cause code mapping entry to use from <a href="#">_advanced.incoming_cause_mapping</a> to map incoming cause codes on this BRI link
	✓		✓	✓	<a href="#">outgoing_cause_mapping_index</a> =0	APPLY	Index	Cause code mapping entry to use from <a href="#">_advanced.outgoing_cause_mapping</a> to map outgoing cause codes on this BRI link



FXS/FXO	BRI	E/T1	H 3 2 3	S I P	Section/Parameter	Activate	Range	Comments
	✓ U S			✓	registered_dn=5551000			Configuration for US BRI (... when network=att_TE)
	✓		✓	✓	<a href="#">setup_mapping_index</a> =0	APPLY	Index	Mapping entry to use from <a href="#">advanced.setup_mapping</a> for this BRI LINK
	✓ U S			✓	spid1=1001			Configuration for US BRI (... when network=att_TE)
	✓ U S			✓	spid2=1002			Configuration for US BRI (... when network=att_TE)
	✓		✓	✓	wait_for_calling_name_time=0		0 .. 10000	In some (particularly T1) systems, the caller's display name may be sent as a facility message after the initial set up. If the Vega is to use this in the outgoing VoIP call the Vega must wait for the facility message to arrive. This parameter tells the Vega how long to wait (in ms).
					<b>[call_control.timers.1]</b>			Currently only 1 set, set 1 supported
✓	✓	✓	✓	✓	T301_timeout=90	S/R	0 to 1000	Ringing timeout in seconds
✓	✓	✓	✓	✓	T301_cause=19	S/R	0 to 127	Q.850 cause code to use on Ring Tone No Reply timeout (see IN 18 for cause code details)
					<b>[cron.entry.1]</b>			
✓	✓	✓	✓	✓	enable=1	Apply	0 or 1	0 = disable 1 = enable
✓	✓	✓	✓	✓	script=blank	Apply	Alpha numeric string 1..64 chars	Command file to pick up and execute (scheduled autoexec)
✓	✓	✓	✓	✓	when=never	Apply	Alpha numeric string 1..80 chars	Never = do not execute ever Space separated values for "minute" "hour" "day of month" "month" "day of week"  Where:  * Matches every minute, hour etc. n One specific minute/hour/etc. n,m A comma-delimited list of matching minutes/hours/etc. n-m An inclusive range of minutes/hours/etc. /n "every n intervals" used to modify a range  e.g. 12 23-7/2 * * 1,7 will run a script at 12 minutes past every other hour (because of the "/2") between 23 (11pm) and 7 (7am), on every Monday or Sunday.  12 0-6 * 7 * will run a script at 12 minutes past the hour between 0 (midnight) and 6 (6am),

FXS/ FXO	BRI	E/T1	H 3 2 3	S I P	Section/Parameter	Activate	Range	Comments
								but only during the month of July.
					[dns]			
✓	✓	✓	✓	✓	dhcp_if=1		0 or 1 or 2	1..2 - Lan interface to get DHCP IP address from - if DHCP for dns is enabled in that interface  0 - do not use DHCP to get dns IP
					[dns.1]			
✓	✓	✓	✓	✓	ip=0.0.0.0	S/R	IP address	Domain name server IP (0.0.0.0 for none)  Note 1: Dynamically assigned DNS IP address takes precedence over statically defined IP addresses  Note 2: If a static DNS entry has the same IP address as the dynamic one, the dynamic IP address will be ignored and the static entry used
					[dsp]			DSP parameters section
					[dsp.gsm]			Config for specific codec
✓	✓	✓	✓	✓	echo_tail_size=16	CALL	0/8/16/32/64/128	Echo cancellation tail size in ms
✓	✓	✓	✓	✓	idle_noise_level= -5000	CALL	-10000 to 10000	Background "comfort" noise level for silence suppression
✓	✓	✓	✓	✓	packet_time_max=80	CALL	10/20/30	Maximum packet sampling size in milliseconds
✓	✓	✓	✓	✓	packet_time_min=10	CALL	10/20/30	Minimum packet sampling size in milliseconds
✓	✓	✓	✓	✓	packet_time_step=10	CALL	10	Step size - only single value allowed
✓	✓	✓	✓	✓	VADU_threshold=0	CALL	-20 to 10	Threshold for activation of silence suppression
✓	✓	✓	✓	✓	rx_gain=0	CALL	-14 to 14	Receive (LAN to telephony) gain in db
✓	✓	✓	✓	✓	tx_gain=0	CALL	-14 to 14	Transmit (telephony to LAN) gain in db  FXO: Care must be taken as the gain is applied on the telephony side of the DSP, so altering this gain alters the gain of DTMF tones played to the Vega by the PBX/PSTN. Increasing / decreasing the gain too much can take the DTMF tone volume out of detection range.
					[dsp.gsm.voice]			
✓	✓	✓	✓	✓	EC_enable=enable		enable or disable	Enable or disable echo cancellation
✓	✓	✓	✓	✓	VADU_allow=yes		yes or no	Enable/disable silence suppression (voice activity detection) mode
✓	✓	✓	✓	✓	VP_FIFO_max_delay=500	CALL	10 to 160	10 to 160 - Jitter buffer max size in ms
✓	✓	✓	✓	✓	VP_FIFO_nom_delay=60	CALL	10 to 160	10 to 160 - Jitter buffer min size in ms
✓	✓	✓	✓	✓			disable,	

FXS/FXO	BRI	E/T1	H323	SIP	Section/Parameter	Activate	Range	Comments
					VP_adaptive_playout=silence		silence or immediate	
✓	✓	✓	✓	✓	resampling_control=disable		disable or enable	
					<b>[dsp.g711Alaw64k]</b>			Config for specific codec
✓	✓	✓	✓	✓	echo_tail_size=16	CALL	0/8/16/32/64/128	Echo cancellation tail size in ms
✓	✓	✓	✓	✓	idle_noise_level= -5000	CALL	-10000 to 10000	Background "comfort" noise level for silence suppression
✓	✓	✓	✓	✓	packet_time_max=30	CALL	10/20/30	Maximum packet sampling size in milliseconds
✓	✓	✓	✓	✓	packet_time_min=10	CALL	10/20/30	Minimum packet sampling size in milliseconds
✓	✓	✓	✓	✓	packet_time_step=10	CALL	10	Step size - only single value allowed
✓	✓	✓	✓	✓	VADU_threshold=0	CALL	-20 to 10	Threshold for activation of silence suppression
✓	✓	✓	✓	✓	rx_gain=0	CALL	-14 to 14	Receive (LAN to telephony) gain in db
✓	✓	✓	✓	✓	tx_gain=0	CALL	-14 to 14	Transmit (telephony to LAN) gain in db  FXO: Care must be taken as the gain is applied on the telephony side of the DSP, so altering this gain alters the gain of DTMF tones played to the Vega by the PBX/PSTN. Increasing / decreasing the gain too much can take the DTMF tone volume out of detection range.
					<b>[dsp.g711Alaw64k.data]</b>			
✓	✓	✓	✓	✓	EC_enable=disable		enable or disable	Enable or disable echo cancellation
✓	✓	✓	✓	✓	VADU_allow=no		yes or no	Enable/disable silence suppression (voice activity detection) mode
✓	✓	✓	✓	✓	VP_FIFO_max_delay=120	CALL	10 to 160 1 to 9	10 to 160 - Jitter buffer max size in ms 1 to 9 - Jitter buffer max size (multiples of packet_time)
✓	✓	✓	✓	✓	VP_FIFO_nom_delay=60	CALL	10 to 160 1 to 9	10 to 160 - Jitter buffer min size in ms 1 to 9 - Jitter buffer min size (multiples of packet_time)
✓	✓	✓	✓	✓	VP_adaptive_playout=disable		disable, silence or immediate	For engineering use only, do not change
✓	✓	✓	✓	✓	resampling_control=enable		disable or enable	For engineering use only, do not change
					<b>[dsp.g711Alaw64k.voice]</b>			
✓	✓	✓	✓	✓	EC_enable=enable		enable or disable	Enable or disable echo cancellation
✓	✓	✓	✓	✓	VADU_allow=yes		yes or no	Enable/disable silence suppression (voice activity detection) mode

FXS/EXO	BRI	E/T1	H323	SIP	Section/Parameter	Activate	Range	Comments
✓	✓	✓	✓	✓	VP_FIFO_max_delay=120	CALL	10 to 160	10 to 160 - Jitter buffer max size in ms
✓	✓	✓	✓	✓	VP_FIFO_nom_delay=60	CALL	10 to 160	10 to 160 - Jitter buffer min size in ms
✓	✓	✓	✓	✓	VP_adaptive_playout=silence		disable, silence or immediate	
✓	✓	✓	✓	✓	resampling_control=disable		disable or enable	
					<b>[dsp.g711Ulaw64k]</b>			Config for specific codec
✓	✓	✓	✓	✓	echo_tail_size=16	CALL	0/8/16/32/64/128	Echo cancellation tail size in ms
✓	✓	✓	✓	✓	idle_noise_level= -5000	CALL	-10000 to 10000	Background "comfort" noise level for silence suppression
✓	✓	✓	✓	✓	packet_time_max=30	CALL	10/20/30	Maximum packet sampling size in milliseconds
✓	✓	✓	✓	✓	packet_time_min=10	CALL	10/20/30	Minimum packet sampling size in milliseconds
✓	✓	✓	✓	✓	packet_time_step=10	CALL	10	Step size - only single value allowed
✓	✓	✓	✓	✓	VADU_threshold=0	CALL	-20 to 10	Threshold for activation of silence suppression
✓	✓	✓	✓	✓	rx_gain=0	CALL	-14 to 14	Receive (LAN to telephony) gain in db
✓	✓	✓	✓	✓	tx_gain=0	CALL	-14 to 14	Transmit (telephony to LAN) gain in db  FXO: Care must be taken as the gain is applied on the telephony side of the DSP, so altering this gain alters the gain of DTMF tones played to the Vega by the PBX/PSTN. Increasing / decreasing the gain too much can take the DTMF tone volume out of detection range.
					<b>[dsp.g711Ulaw64k.data]</b>			
✓	✓	✓	✓	✓	EC_enable=disable		enable or disable	Enable or disable echo cancellation
✓	✓	✓	✓	✓	VADU_allow=no		yes or no	Enable/disable silence suppression (voice activity detection) mode
✓	✓	✓	✓	✓	VP_FIFO_max_delay=120	CALL	10 to 160 1 to 9	10 to 160 - Jitter buffer max size in ms 1 to 9 - Jitter buffer max size (multiples of packet_time)
✓	✓	✓	✓	✓	VP_FIFO_nom_delay=40	CALL	10 to 160 1 to 9	10 to 160 - Jitter buffer min size in ms 1 to 9 - Jitter buffer min size (multiples of packet_time)
✓	✓	✓	✓	✓	VP_adaptive_playout=disable		disable, silence or immediate	
✓	✓	✓	✓	✓	resampling_control=enable		disable or enable	
					<b>[dsp.g711Ulaw64k.voice]</b>			
✓	✓	✓	✓	✓	EC_enable=enable		enable or disable	Enable or disable echo cancellation

FXS/FXO	BRI	E/T1	H323	SIP	Section/Parameter	Activate	Range	Comments
✓	✓	✓	✓	✓	VADU_allow=yes		yes or no	Enable/disable silence suppression (voice activity detection) mode
✓	✓	✓	✓	✓	VP_FIFO_max_delay=120	CALL	10 to 160	10 to 160 - Jitter buffer max size in ms
✓	✓	✓	✓	✓	VP_FIFO_nom_delay=60	CALL	10 to 160	10 to 160 - Jitter buffer min size in ms
✓	✓	✓	✓	✓	VP_adaptive_playout=silence		disable, silence or immediate	
✓	✓	✓	✓	✓	resampling_control=disable		disable or enable	
					<b>[dsp.g729AnnexA]</b>			Config for specific codec
✓	✓	✓	✓	✓	echo_tail_size=16	CALL	0/8/16/32/64/128	Echo cancellation tail size in ms
✓	✓	✓	✓	✓	idle_noise_level= -5000	CALL	-10000 to 10000	Background "comfort" noise level for silence suppression
✓	✓	✓	✓	✓	packet_time_max=80	CALL	10/20/30/40/50/60/70/80	Maximum packet sampling size in milliseconds
✓	✓	✓	✓	✓	packet_time_min=10	CALL	10/20/30/40/50/60/70/80	Minimum packet sampling size in milliseconds
✓	✓	✓	✓	✓	packet_time_step=10	CALL	10	Step size - only single value allowed
✓	✓	✓	✓	✓	VADU_threshold=0	CALL	-20 to 10	Threshold for activation of silence suppression
✓	✓	✓	✓	✓	rx_gain=0	CALL	-14 to 14	Receive (LAN to telephony) gain in db
✓	✓	✓	✓	✓	tx_gain=0	CALL	-14 to 14	Transmit (telephony to LAN) gain in db  FXO: Care must be taken as the gain is applied on the telephony side of the DSP, so altering this gain alters the gain of DTMF tones played to the Vega by the PBX/PSTN. Increasing / decreasing the gain too much can take the DTMF tone volume out of detection range.
					<b>[dsp.g729AnnexA.voice]</b>			
✓	✓	✓	✓	✓	EC_enable=enable		enable / disable	Enable or disable echo cancellation
✓	✓	✓	✓	✓	VADU_allow=yes		yes or no	Enable/disable silence suppression (voice activity detection) mode
✓	✓	✓	✓	✓	VP_FIFO_max_delay=500	CALL	10 to 500 1 to 9	10 to 500 - Jitter buffer max size in ms 1 to 9 - Jitter buffer max size (multiples of packet_time)
✓	✓	✓	✓	✓	VP_FIFO_nom_delay=60	CALL	10 to 500 1 to 9	10 to 500 - Jitter buffer min size in ms 1 to 9 - Jitter buffer min size (multiples of packet_time)
✓	✓	✓	✓	✓	VP_adaptive_playout=silence		disable, silence or immediate	
✓	✓	✓	✓	✓	resampling_control=disable		disable or enable	

FXS/FXO	BRI	E/T1	H323	SIP	Section/Parameter	Activate	Range	Comments
					[dsp.g729]			Config for specific codec
✓	✓	✓	✓	✓	echo_tail_size=16	CALL	0/8/16/32/64/128	Echo cancellation tail size in ms
✓	✓	✓	✓	✓	idle_noise_level= -5000	CALL	-10000 to 10000	Background "comfort" noise level for silence suppression
✓	✓	✓	✓	✓	packet_time_max=80	CALL	10/20/30/40/50/60/70/80	Maximum packet sampling size in milliseconds
✓	✓	✓	✓	✓	packet_time_min=10	CALL	10/20/30/40/50/60/70/80	Minimum packet sampling size in milliseconds
✓	✓	✓	✓	✓	packet_time_step=10	CALL	10	Step size - only single value allowed
✓	✓	✓	✓	✓	VADU_threshold=0	CALL	-20 to 10	Threshold for activation of silence suppression
✓	✓	✓	✓	✓	rx_gain=0	CALL	-14 to 14	Receive (LAN to telephony) gain in db
✓	✓	✓	✓	✓	tx_gain=0	CALL	-14 to 14	Transmit (telephony to LAN) gain in db  FXO: Care must be taken as the gain is applied on the telephony side of the DSP, so altering this gain alters the gain of DTMF tones played to the Vega by the PBX/PSTN. Increasing / decreasing the gain too much can take the DTMF tone volume out of detection range.
					[dsp.g729.voice]			
✓	✓	✓	✓	✓	EC_enable=enable		enable / disable	Enable or disable echo cancellation
✓	✓	✓	✓	✓	VADU_allow=yes		yes or no	Enable/disable silence suppression (voice activity detection) mode
✓	✓	✓	✓	✓	VP_FIFO_max_delay=500	CALL	10 to 500 1 to 9	10 to 500 - Jitter buffer max size in ms 1 to 9 - Jitter buffer max size (multiples of packet_time)
✓	✓	✓	✓	✓	VP_FIFO_nom_delay=60	CALL	10 to 500	10 to 500 - Jitter buffer min size in ms
✓	✓	✓	✓	✓	VP_adaptive_playout=silence		disable, silence or immediate	
✓	✓	✓	✓	✓	resampling_control=disable		disable or enable	
					[dsp.g7231]			Config for specific codec
✓	✓	✓	✓	✓	echo_tail_size=16	CALL	0/8/16/32/64/128	Echo cancellation tail size in ms
✓	✓	✓	✓	✓	idle_noise_level= -5000	CALL	-10000 to 10000	Background "comfort" noise level for silence suppression
✓	✓	✓	✓	✓	packet_time_max=60	CALL	30/60	Maximum packet sampling size in milliseconds
✓	✓	✓	✓	✓	packet_time_min=30	CALL	30/60	Minimum packet sampling size in milliseconds
✓	✓	✓	✓	✓	packet_time_step=30	CALL	30	Step size - only single value allowed
✓	✓	✓	✓	✓	VADU_threshold=0	CALL	-20 to 10	Threshold for activation of silence suppression

FXS/FXO	BRI	E/T1	H323	SIP	Section/Parameter	Activate	Range	Comments
✓	✓	✓	✓	✓	rx_gain=0	CALL	-14 to 14	Receive (LAN to telephony) gain in db
✓	✓	✓	✓	✓	tx_gain=0	CALL	-14 to 14	Transmit (telephony to LAN) gain in db  FXO: Care must be taken as the gain is applied on the telephony side of the DSP, so altering this gain alters the gain of DTMF tones played to the Vega by the PBX/PSTN. Increasing / decreasing the gain too much can take the DTMF tone volume out of detection range.
					[dsp.g7231.voice]			
✓	✓	✓	✓	✓	EC_enable=enable		enable or disable	Enable or disable echo cancellation
✓	✓	✓	✓	✓	VADU_allow=yes		yes or no	Enable/disable silence suppression (voice activity detection) mode
✓	✓	✓	✓	✓	VP_FIFO_max_delay=500	CALL	10 to 500 1 to 9	10 to 500 - Jitter buffer max size in ms 1 to 9 - Jitter buffer max size (multiples of packet_time)
✓	✓	✓	✓	✓	VP_FIFO_nom_delay=60	CALL	10 to 500	10 to 500 - Jitter buffer min size in ms
✓	✓	✓	✓	✓	VP_adaptive_playout=silence		disable, silence or immediate	
✓	✓	✓	✓	✓	resampling_control=disable		disable or enable	
					[dsp.octet]			
✓	✓	✓	✓	✓	VP_FIFO_max_delay=4	CALL	1 to 9	1 to 9 - Jitter buffer max size (multiples of packet_time)
✓	✓	✓	✓	✓	VP_FIFO_nom_delay=2	CALL	1 to 9	1 to 9 - Jitter buffer min size (multiples of packet_time)
✓	✓	✓	✓	✓	packet_time_max=20	CALL	10/20	Maximum packet sampling size in milliseconds
✓	✓	✓	✓	✓	packet_time_min=10	CALL	10	Minimum packet sampling size in milliseconds
✓	✓	✓	✓	✓	packet_time_step=10	CALL	10	Step size - only single value allowed
✓	✓	✓	✓	✓	resampling_control=disable disable or enable			
					[dsp.t38]			Config for fax over IP protocol
✓	✓	✓	✓	✓	cd_threshold=-33	CALL	-26/-33/-43	Carrier Detect detection threshold in db
✓	✓	✓	✓	✓	FP_FIFO_nom_delay=300	CALL	0 to 600	Jitter buffer min size in ms
✓	✓	✓	✓	✓	network_timeout=150	CALL	0 to 10000	Network_timeout specifies the period after which the dsp will disconnect the fax if it does not receive any packets from the lan side.
✓	✓	✓	✓	✓	packet_time=40	CALL	10/20/30/40/ 50/60/ 70/80	Packet sampling size in milliseconds
✓	✓	✓	✓	✓	rate_max=144	CALL	24/48/72/96/1 20/144	Maximum fax connection rate

FXS/FXO	BRI	E/T1	H 3 2 3	S I P	Section/Parameter	Activate	Range	Comments
✓	✓	✓	✓	✓	rate_min=24	CALL	24/48/72/96/120/144	Minimum fax connection rate
✓	✓	✓	✓	✓	rate_step=24	CALL	24	Step size - only single value allowed
✓	✓	✓	✓	✓	timeout=15	CALL	10 to 120	Timeout is the period after which the dsp will disconnect the fax if it does not detect any TDM activity.
✓	✓	✓	✓	✓	tx_level=-8	CALL	-13 to 0	Transmit gain in db
					[elt1]			
		✓	✓	✓	topology=e1	S/R	e1/t1	Network topology or card type
					[elt1.port.1]			
		✓	✓	✓	<a href="#">bus_master_priority=1</a>	APPLY	0 to 4	Preference level for synchronising the internal clock to this port, 1 = highest priority, 4 = lowest, 0 = don't use this port
		✓	✓	✓	bypass_mode=normal	normal, bypass, manual		<p>Vega 400 ByPass relay controls ...</p> <p>normal:</p> <ul style="list-style-type: none"> <li>• Vega will be in ByPass mode</li> <li>• when powered down,</li> <li>• when an upgrade is being performed on it, or</li> <li>• when it is being rebooted.</li> </ul> <p>Otherwise Vega will terminate the telecom connections and generate and receive calls.</p> <p>bypass:</p> <p>Vega will always be in ByPass - it will not receive any telephony calls and will not be able to make any telephony calls.</p> <p>manual:</p> <p>When configured as manual, the Vega will remain in ByPass mode after a power on or a reboot until a manual 'elt1 bypass off' command is executed.</p> <p>For further details, see IN_44-Vega_400_ByPass_relays on the technical documents page of <a href="http://www.VegaAssist.com">www.VegaAssist.com</a></p>
		✓	✓	✓	clock_master=0	S/R	0 or 1	0 for no clock generation, 1 for clock generation



FXS/EXO	BRI	E/T1	H 3 2 3	S I P	Section/Parameter	Activate	Range	Comments
		✓	✓	✓	disc_on_user_suspend=0		0 or 1	0: normal operation 1: on receipt of an incoming ISDN NOTIFY message containing a NOTIFY INDICATOR = USER SUSPEND the Vega will initiate call disconnection. This gets round the problem of the 90 second clear-down timer where a called party gets re-connected to the calling party again if they pick up the phone within 90 seconds and the calling party has not cleared down at their end.
		✓	✓	✓	enable=on	APPLY	0/1/off/on/timing	Trunk enabled 0, off: trunk is disabled 1, on: trunk is enabled timing: trunk is used for timing (Vega won't bring up layer 2/3). If configured as NT, the Vega will generate clock signal on this trunk; if configured as TE, the Vega will treat an incoming clock as a valid clock to synchronise to.
		✓ E 1	✓	✓	<a href="#">ei_rx_short_haul</a> =1	S/R	0 or 1	0 = long haul (>6dB attenuation in line) 1 = short haul (<=6dB attenuation in line)
		✓	✓	✓	framing=auto	S/R	esf/sf/crc4/ pcm30/auto	T1: Extended Super frame / Super frame (SF = D4); auto=esf E1: CRC4 / PCM30 (PCM30 = no CRC4); auto=crc4
		✓	✓	✓	line_encoding=auto	S/R	2b1q/b8zs/ami/ hdb3/ auto	Line encoding type used T1: b8zs / ami; auto=b8zs E1: hdb3; auto=hdb3
		✓	✓	✓	lyr1=auto	APPLY	G711Alaw64k/ g711Ulaw64k/ auto	A-law or u-law companding (G.711Alaw64k/G.711Ulaw64k) on the E1T1 auto=g711Alaw64k
		✓	✓	✓	network=auto	S/R	etsi/ ni/att/dms/ qsig/ dms_m1/ rbs/auto	Network type. "auto" configures "etsi" for E1 systems and "dms" for T1 systems.
		✓	✓	✓	nt=0	APPLY	0 or 1	For ISDN: 0=TE, 1=NT; For QSIG: 0= Slave or B-side, 1=Master or A-side For RBS (CAS): - not used
		✓ T 1	✓	✓	<a href="#">t1_tx_equalization</a> =sh220_330		lhlbo0 lhlbo7_5 lhlbo15 lhlbo22_5 sh0_110 sh110_220 sh220_330 sh330_440 sh440_550 sh550_660	Specify the transmit equalization (for T1 interfaces only).

FXS/EXO	BRI	E/T1	H 3 2 3	S I P	Section/Parameter	Activate	Range	Comments
					[elt1.port.1.group.1]			
		✓	✓	✓	<a href="#">alloc_chan</a> =default	S/R	default/ linear_up/ linear_down/ round_robin	Type of channel allocation strategy used (default = linear up if E1T1 is NT and Linear down if E1T1 is TE)
		✓	✓	✓	dn=*	S/R	Length<32	Vega 400: unused for Caller ID or incoming number detection.
		✓	✓	✓	<a href="#">first_chan</a> =1	S/R	E1: 1-30 T1 PRI: 1-23 T1 CAS: 1-24	First B-chan for this group
		✓	✓	✓	interface=0401	S/R	Length<32	Interface ID for this E1T1 0401 to 0404
		✓	✓	✓	<a href="#">last_chan</a> =auto	S/R	E1: 1..30, auto T1 PRI: 1..23, auto T1 CAS: 1..24, auto	Last B-chan for this group  Note. If the E1T1 is connected to a partial T1 or E1 ensure that last_chan is configured appropriately, otherwise calls may be placed to non existent channels
		✓	✓	✓	tunnel_IEs_only=1		0 or 1	Tunnel specific information elements. IEs to tunnel are defined in <a href="#">_advanced.isdn.IEs_to_tunnel</a> .  N.B. Enable this parameter for both source AND destination trunks (for ISDN to ISDN tunnelling)  See table in section <a href="#">10.5.3 "Tunnelling full signalling messages and IEs in ISDN (ETSI, ATT, DMS, DMS-M1, NI, VN 3/4) and QSIG"</a> for details of interactions of various parameters with tunnel_IEs_only.
		✓	✓	✓	<a href="#">tunnel_mode</a> =on-demand	S/R	off/on-demand	Enable tunnelling, for full details see the table in section <a href="#">10.5.3 "Tunnelling full signalling messages and IEs in ISDN (ETSI, ATT, DMS, DMS-M1, NI, VN 3/4) and QSIG"</a>
					[elt1.port.1.isdn]			<a href="#">ISDN</a> and <a href="#">QSIG</a> config
		✓	✓	✓	chanid_excl=0	APPLY	0 or 1	Affects the 'preferred/exclusive' bit in the ISDN B-Channel Id Info Element of outbound ISDN calls 0 = 'preferred' 1 = 'exclusive' ... far end to drop call if this B-channel cannot be used
		✓	✓	✓	isdn.d_channel=16	APPLY	0-32	Channel to be used for the D-Channel (signalling channel)
		✓	✓	✓	dtmf_dial_digit=#	APPLY	0 to 9, *, #, A to D, Z	DTMF dial termination character - the DTMF character that indicates that the dialled number is complete (overrides dtmf_dial_timeout) forcing the received number to be passed to the dial plan router (set to Z to disable this function)
		✓	✓	✓	dtmf_dial_timeout=5	APPLY	1-999	Time after last dialled digit is received that dialled number is forwarded to the dial

FXS/ FXO	BRI	E/T1	H 3 2 3	S I P	Section/Parameter	Activate	Range	Comments
								plan router (in seconds) 999 = no timeout used
		✓	✓	✓	end_to_end_call_proceeding=0	APPLY	0,1	0 = Disabled 1 = Enabled, For ISDN to ISDN calls Vega will wait for incoming call proceeding message before transmitting call proceeding message on the originating ISDN link.
		✓	✓	✓	<a href="#">incoming_cause_mapping_index</a> =0	APPLY	Index	Cause code mapping entry to use from <a href="#">advanced.incoming_cause_mapping</a> to map incoming cause codes on this E1T1
		✓		✓	mwi_enable=0	APPLY	0,1	0 = Disabled 1 = Enabled, Enable reception or generation of message waiting indicator. Can be used to map SIP MWI to ISDN devices.
		✓	✓	✓	<a href="#">outgoing_cause_mapping_index</a> =0	APPLY	Index	Cause code mapping entry to use from <a href="#">advanced.outgoing_cause_mapping</a> to map outgoing cause codes on this E1T1
		✓	✓	✓	<a href="#">setup_mapping_index</a> =0	APPLY	Index	Mapping entry to use from <a href="#">advanced.setup_mapping</a> for this E1T1
		✓		✓	untromboning_enable=0	APPLY	0,1	0 = Disabled 1 = Enabled, Allow the Vega to untrombone (or optimise) bearer channels when SIP indicates this can be done.
		✓	✓	✓	wait_for_calling_name_time=0		0 to 10000	In some (particularly T1) systems, the caller's display name may be sent as a facility message after the initial set up. If the Vega is to use this in the outgoing VoIP call the Vega must wait for the facility message to arrive. This parameter tells the Vega how long to wait (in ms).
					<a href="#">[elt1.port.1.rbs]</a>			T1 CAS - RBS configuration
		✓	✓	✓	digit_dial_timeout=2	APPLY	1 .. 1000	Time after last dialled digit is received that DNIS / ANI are treated as complete - time is in seconds (Initial digit timeout = 10 times this value)
		✓	✓	✓	fsk_time_type=DST	APPLY	base or DST	Base: use base local time for Caller ID time DST: use Daylight Saving Time for Caller ID time
		✓	✓	✓	fsk_tone_delay=2000		1..20000	Milliseconds delay after seize before sending the FSK caller ID (if enabled in fsk_tone_format)
		✓	✓	✓	fsk_tone_format=off		off, gr30-sdmf, gr30-mdmf	When using a Vega 400 with a CAS channel bank that does not support caller ID, the Vega can generate the FSK tones. This parameter enables the tone generation and defines the format of the FSK.
		✓	✓	✓	info=dtmf	APPLY	dtmf or mf	DTMF tones or MF tones can be used to send DNIS / ANI

FXS/FXO	BRI	E/T1	H 3 2 3	S I P	Section/Parameter	Activate	Range	Comments
		✓	✓	✓	progress_tones_present=1		0 or 1	0: no progress tones indicated in progress message sent from CAS to router after dialling is complete  1: progress tones indicated in progress message sent from CAS to router after dialling is complete
		✓	✓	✓	<a href="#">rx_dial_format=.</a>	APPLY	. = default format  or Format of DNIS/ANI	Define the format of the ANI/ DNIS in the CAS signalling - for incoming CAS calls (received ANI/DNIS).  o = ANI, n = DNIS  DTMF can use the separator characters: 0-9, A-D, *,#, ~  MF can use the separator characters: 0-9, K, S, ~
		✓	✓	✓	signal=em_wink	S/R	em_wink, loopstart, gndstart, or fgd	CAS RBS signalling type (fgd = em_wink supporting feture group D - em_wink supports feature group B)
		✓	✓	✓	tone_delay=50	APPLY	1 to 1000	Delay after the remote end has sent acknowledgement wink (in E&M wink start signalling) before starting to play the outbound DNIS and ANI tones (in milliseconds)
		✓	✓	✓	<a href="#">tx_dial_format=.</a>	APPLY	. = default format  or Format of DNIS/ANI	Define the format of the ANI/ DNIS in the CAS signalling - for outgoing CAS calls (transmitted ANI/DNIS).  o = ANI, n = DNIS  DTMF can use the separator characters: 0-9, A-D, *,#, ~  MF can use the separator characters: 0-9, K, S, ~

FXS/EXO	BRI	E/T1	H 3 2 3	S I P	Section/Parameter	Activate	Range	Comments
					[elt1.port.1.r2]			
		✓	✓	✓	category=sub_wo_pri_nl		sub_w_pri_nl/ sub_wo_pri_nl / mnt_equip_nl/ data_trns_nl/ sub_wo_pri_il / data_trans_il / sub_w_pri_il / op_fwd_trns_i l	Subscriber with priority Subscriber without priority  Maintenance Equipment Data transmission Subscriber without forward transfer  Data transmission  Subscriber with priority  Operator with forward transfer capability
		✓	✓	✓	operation_mode=bothway		incoming/ outgoing/ bothway	
		✓	✓	✓	profile=1		1 .. 10	R2MFC profile to use (see E1T1.r2_profile.x)
					[elt1.r2_profile.1]			R2 MFC profile 1 of up to 10
		✓	✓	✓	name=ITU		length<32	Name - for self documentation purposes
		✓	✓	✓	variant=ITU		Argentina / Brazil / ITU / Mexico	R2 standard configuration on which to base the R2 configuration.
					[elt1.r2_profile.1.line]			
		✓	✓	✓	answer_delay_time=100		0.. 180000	
		✓	✓	✓	answer_in_pattern=0101		Binary value 0000 to 1111 or none	
		✓	✓	✓	answer_out_pattern=0101		Binary value 0000 to 1111 or none	
		✓	✓	✓	answer_receive_time=1000		0 .. 180000	
		✓	✓	✓	billing_in_pattern=0000		Binary value 0000 to 1111 or none	
		✓	✓	✓	billing_off_time=0		0 .. 180000	
		✓	✓	✓	billing_on_time=0		0 .. 180000	
		✓	✓	✓	billing_out_pattern=0000		Binary value 0000 to 1111 or none	
		✓	✓	✓	blocking_in_pattern=1101		Binary value 0000 to 1111 or none	
		✓	✓	✓	blocking_out_pattern=1101		Binary value 0000 to 1111 or none	
		✓	✓	✓	blocking_receive_time=200		0 .. 180000	

FXS/EXO	BRI	E/T1	H323	SIP	Section/Parameter	Activate	Range	Comments
		✓	✓	✓	chk_enable_billing=0		0 or 1	
		✓	✓	✓	chk_force_disc=0		0 or 1	
		✓	✓	✓	clear_back_in_pattern=1101		Binary value 0000 to 1111 or none	
		✓	✓	✓	clear_back_out_pattern=1101		Binary value 0000 to 1111 or none	
		✓	✓	✓	clear_back_receive_time=20		0 .. 180000	
		✓	✓	✓	clear_forward_in_pattern=1001		Binary value 0000 to 1111 or none	
		✓	✓	✓	clear_forward_out_pattern=1001		Binary value 0000 to 1111 or none	
		✓	✓	✓	clear_forward_receive_time=150		0 .. 180000	
		✓	✓	✓	error_in_pattern=0000		Binary value 0000 to 1111 or none	
		✓	✓	✓	error_out_pattern=0000		Binary value 0000 to 1111 or none	
		✓	✓	✓	force_disc_pattern=0000		Binary value 0000 to 1111 or none	
		✓	✓	✓	idle_in_pattern=1001		Binary value 0000 to 1111 or none	
		✓	✓	✓	idle_out_pattern=1001		Binary value 0000 to 1111 or none	
		✓	✓	✓	idle_receive_time=100		0 .. 180000	
		✓	✓	✓	seize_ack_in_pattern=1101		Binary value 0000 to 1111 or none	
		✓	✓	✓	seize_ack_out_pattern=1101		Binary value 0000 to 1111 or none	
		✓	✓	✓	seize_ack_receive_time=300		0 .. 180000	
		✓	✓	✓	seize_in_pattern=0001		Binary value 0000 to 1111 or none	
		✓	✓	✓	seize_out_pattern=0001		Binary value 0000 to 1111 or none	
		✓	✓	✓	seize_receive_time=10		0 .. 180000	
					[elt1.r2_profile.1.register]			
		✓	✓	✓	access_to_test_equip=13		0 .. 15	
		✓	✓	✓	addr_complete_chg_setup_speech=6		0 .. 15	

FXS / FXO	BRI	E/T1	H 3 2 3	S I P	Section/Parameter	Activate	Range	Comments
		✓	✓	✓	addr_complete_rcv_grp_b=3		0 .. 15	
		✓	✓	✓	call_from_operator=4		0 .. 15	
		✓	✓	✓	calling_party_category=5		0 .. 15	
		✓	✓	✓	cc_ind=11		0 .. 15	
		✓	✓	✓	congestion=4		0 .. 15	
		✓	✓	✓	congestion_intl=15		0 .. 15	
		✓	✓	✓	congestion_ntl=4		0 .. 15	
		✓	✓	✓	country_code_ind=11		0 .. 15	
		✓	✓	✓	data_trans_call=6		0 .. 15	
		✓	✓	✓	delay_op=12		0 .. 15	
		✓	✓	✓	digit_0=10		0 .. 15	
		✓	✓	✓	digit_b=0		0 .. 15	
		✓	✓	✓	digit_c=0		0 .. 15	
		✓	✓	✓	digit_d=0		0 .. 15	
		✓	✓	✓	digit_e=0		0 .. 15	
		✓	✓	✓	digit_f=0		0 .. 15	
		✓	✓	✓	digit_1=1		0 .. 15	
		✓	✓	✓	digit_2=2		0 .. 15	
		✓	✓	✓	digit_3=3		0 .. 15	
		✓	✓	✓	digit_4=4		0 .. 15	
		✓	✓	✓	digit_5=5		0 .. 15	
		✓	✓	✓	digit_6=6		0 .. 15	
		✓	✓	✓	digit_7=7		0 .. 15	
		✓	✓	✓	digit_8=8		0 .. 15	
		✓	✓	✓	digit_9=9		0 .. 15	
		✓	✓	✓	disc_digit=10		0 .. 15	
		✓	✓	✓	end_of_ani=15		0 .. 15	
		✓	✓	✓	end_of_dni=15		0 .. 15	
		✓	✓	✓	incoming_op=11		0 .. 15	
		✓	✓	✓	lang_digit=2		0 .. 15	
		✓	✓	✓	line_busy=3		0 .. 15	
		✓	✓	✓	line_free_charge=6		0 .. 15	
		✓	✓	✓	line_free_no_charge=7		0 .. 15	
		✓	✓	✓	maintenance equip=3		0 .. 15	
		✓	✓	✓	nature_of_ckt=13		0 .. 15	
		✓	✓	✓	no_echo_supp_reqd=12		0 .. 15	
		✓	✓	✓	num_idle=0		0 .. 15	
		✓	✓	✓	out_of_order=8		0 .. 15	
		✓	✓	✓	outgoing_half_echo_supp=11		0 .. 15	
		✓	✓	✓	outgoing_half_echo_supp_ins=		0 .. 15	

FXS/FXO	BRI	E/T1	H323	SIP	Section/Parameter	Activate	Range	Comments
					14			
		✓	✓	✓	repeat_did_digits=0		0 .. 15	
		✓	✓	✓	send_lang_digit=12		0 .. 15	
		✓	✓	✓	send_n_digit=0		0 .. 15	
		✓	✓	✓	send_n_minus_1_digit=2		0 .. 15	
		✓	✓	✓	send_n_minus_2_digit=7		0 .. 15	
		✓	✓	✓	send_n_minus_3_digit=8		0 .. 15	
		✓	✓	✓	send_next_ani=0		0 .. 15	
		✓	✓	✓	send_next_digit=1		0 .. 15	
		✓	✓	✓	spl_tone=2		0 .. 15	
		✓	✓	✓	sub_with_fwd_trans=10		0 .. 15	
		✓	✓	✓	sub_with_priority=2		0 .. 15	
		✓	✓	✓	sub_without_fwd_trans=7		0 .. 15	
		✓	✓	✓	sub_without_priority=1		0 .. 15	
		✓	✓	✓	test_call_ind=13		0 .. 15	
		✓	✓	✓	unallocated_no=5		0 .. 15	
		✓	✓	✓	use_of_echo_supp_info=14		0 .. 15	
					<b>[elt1.r2_profile.1.timers]</b>			
		✓	✓	✓	bkwd_tone_timer=14000		0 .. 30000	
		✓	✓	✓	bkwd1_tone_timer=14000		0 .. 30000	
		✓	✓	✓	fwd_silence_timer=24000		0 .. 30000	
		✓	✓	✓	fwd_tone_timer=15000		0 .. 30000	
					<b>[ftp]</b>			FTP parameters
✓	✓	✓	✓	✓	abort_before_close=0		0 or 1	Force an ftp abort before closing the ftp session
✓	✓	✓	✓	✓	anonymous_login=1	P, IMM	0 or 1	When set the Vega will try to access the FTP server using anonymous access - not using the following username and password
✓	✓	✓	✓	✓	enable_size=1	P, APPLY	0 or 1	When set the Vega will use the FTP SIZE command as part of the file transfer process. If disabled the SIZE command is not used.
✓	✓	✓	✓	✓	<a href="#">ip=0.0.0.0</a>	P, APPLY	IP address/ host name	FTP server IP address (0.0.0.0 for none)
✓	✓	✓	✓	✓	lan_profile=1		0 .. 10	Lan profile to use for ftp accesses
✓	✓	✓	✓	✓	ping_test=0	P, IMM	0 or 1	Before an ftp transfer is performed a ping is sent to the far end. The sending of the ping can be disabled by setting this parameter to 0.
✓	✓	✓	✓	✓	_password=whatever	P, IMM	Alpha numeric string 1..64 chars	FTP password for authentication (when not anonymous)  NOTE: this will not be saved by a PUT or TPUT, and will not be displayed by SHOW.



FXS/FXO	BRI	E/T1	H323	SIP	Section/Parameter	Activate	Range	Comments
✓	✓	✓	✓	✓	port=21	P,IMM	1 .. 65535	IP port number for FTP
✓	✓	✓	✓	✓	timeout=20	P,IMM	1 .. 60	FTP timeout
✓	✓	✓	✓	✓	username=whatever	P,IMM	Alpha numeric string 1..32 chars	FTP username for authentication (when not anonymous)
					[h323]			<b>H.323/LAN configuration</b>
					<a href="#">[h323.gatekeeper]</a>			H.323 gatekeeper config
✓	✓	✓	✓		auto_discover=0	S/R	0 or 1	Discover gatekeeper using automatic multicast (default_gatekeeper not used)
		✓			cumulative=0			Reserved for future use
✓	✓	✓	✓		default_ip=0.0.0.0	S/R	IP address/ host name	Gatekeeper IP address for non-automatic discovery
✓	✓	✓	✓		default_port=1719		0 to 65535	Port ID to send gatekeeper (RAS) messages A value zero uses the standard value 1719 NOTE: this value is not used if auto-discovery is used to find the gatekeeper.
✓	✓	✓	✓		enable=0	S/R	0 or 1	Operation with a gatekeeper enabled
✓	✓	✓	✓		<a href="#">qos_profile</a> =0	APPLY	0 to 10	Default QOS profile to use for gatekeeper communication
✓	✓	✓	✓		register_tunnelled_protocols=1		0 or 1	By default the Vega tells the gatekeeper if it support tunnelled protocols (like QSIG tunnelling). Set this parameter to 0 if the gateway to which the Vega registers cannot cope with this information.
✓	✓	✓	✓		support_alt_gk=1		0 or 1	Support alternate gatekeeper functionality (Vega can store up to 20 alternate gatekeeper addresses)
					[h323.gatekeeper.terminal_aliases.1]			Gateway terminal alias list
✓	✓	✓	✓		name=NULL	S/R	Length<32	Alias string; NULL=do not send terminal alias
✓	✓	✓	✓		type=h323	S/R	url/email/e164/h323	Alias type

FXS/EXO	BRI	E/T1	H323	SIP	Section/Parameter	Activate	Range	Comments
					[h323.if.1]			H.323 logical interface behaviour (at present only 1 interface is supported)
					cost=1	S/R	0-9	Not used
✓	✓	✓	✓		default_ip=0.0.0.0	APPLY	IP address/ host name	IP address/host name of default destination H.323 device
✓	✓	✓	✓		default_port=1720	APPLY	1 to 65535	IP port of default destination H.323 device
✓	✓	✓	✓		interface=05	S/R	Length<32	Interface ID of LAN interface
✓	✓	✓	✓		max_calls=60	S/R	E1: 1..120 T1: 1..96 Vega 50: 1..16 Vega 5000: 1..48	Maximum allowable calls in progress
✓	✓	✓	✓		profile=1		0 to 10	Select H.323.profile to use for this interface
✓	✓	✓	✓		<a href="#">qos_profile</a> =0	APPLY	0 to 10	Default QOS profile to use for H.323 Vegas
✓	✓	✓	✓		serviceprofile=0	APPLY	0 to 10	H.450 supplementary service profile to use, 0=disabled, 1-10 define profile
✓	✓	✓	✓		<a href="#">setup_mapping_index</a> =1	APPLY	Index value, 0 to 10	Mapping entry to use from <a href="#">_advanced.setup_mapping</a> for H.323
✓	✓	✓	✓		signal_port_range=6		1 to 40	Specifies which port range list ( <a href="#">_advanced.port_range_list.x</a> ) to use to define the range of local IP ports to use for h.245 signalling
					[h323.profile.1]			Per call behavior (at present only 1 profile is supported) - selected by h323.if.x.profile

FXS/EXO	BRI	E/T1	H323	SIP	Section/Parameter	Activate	Range	Comments
✓	✓	✓	✓		<a href="#">accept_early_h245=1</a>	APPLY	0 or 1	Allow early H.245 on incoming calls
✓	✓	✓	✓		<a href="#">use_early_h245=0</a>	APPLY	0 or 1	Use early H.245 for outgoing calls (Use_fast_start and use_early_h245 are mutually exclusive - select only one; if both are selected use_fast_start overrides use_early_h245)
✓	✓	✓	✓		<a href="#">accept_fast_start=1</a>	APPLY	0, 1, 2 or 3	Allow fast start on incoming calls (1=accept with CONNECT message, 2=accept with ALERTING message, 3=accept with call proceeding)
✓	✓	✓	✓		<a href="#">use_fast_start=1</a>	APPLY	0 or 1	Use fast start for outgoing calls (Use_fast_start and use_early_h245 are mutually exclusive - select only one)
✓	✓	✓	✓		<a href="#">h245_after_fast_start=1</a>	APPLY	0 or 1	Create an H.245 channel after a fast start connection
✓	✓	✓	✓		<a href="#">accept_h245_tunnel=1</a>	APPLY	0 or 1	Allow use of h.245 tunnelling on inbound H.323 calls
✓	✓	✓	✓		<a href="#">use_h245_tunnel=1</a>	APPLY	0 or 1	Try to use h.245 tunnelling on outbound H.323 calls
✓	✓	✓	✓		capset=1	APPLY	0 to 10	Codec capability set (profile) to use for any actions that require a codec capability list, except for faststart calls which uses faststart_capset
✓	✓	✓	✓		faststart_capset=1	APPLY	0 to 10	Codec capability set (profile) to use when initiating a call using faststart.
✓	✓	✓	✓		fax_relay=1		0 or 1	1=enable fax relay using T.38 or G.711 upspeeding
✓	✓	✓	✓		force_early_h245=1		0 or 1	Usually the calling party requests early h.245 (n the SETUP message). If force_early_h245=1, the Vega as a called party will request early h.245 if the calling party has not requested it.
✓	✓	✓	✓		modem_relay=1		0 or 1	1=enable modem relay using G.711 upspeeding
✓	✓	✓	✓		oob_method=signal		signal, alphanumeric or none	Method to use for transmitting Out Of Band DTMF information
✓	✓	✓	✓		h225_version=0	S/R	0 to 3	Set the h.225 version that is output in the Q.931 part of H.323 calls. 0 means the real (RAD stack) version number is reported, other values force that artificial value.
✓	✓	✓	✓		rtd_interval=0	S/R	0 to 60	Round trip delay interval between transmitting RTD response requests - set to non zero to enable. (Typical value=10 (seconds))
✓	✓	✓	✓		rtd_retries=3	S/R	0 .. 32	Number of retries before failing link
✓	✓	✓	✓		setup_info_in_uui=0	S/R	0 or 1	disable/enable proprietary encoding and transfer of calling party presentation and screening indications via user-user-information
✓	✓	✓	✓		setup_sending_complete=0	S/R	0 or 1	disable/enable inclusion of sending complete information element in outgoing H.323 setup message
✓	✓	✓	✓		tx_media_before_connect=0		0 or 1	This parameter only affects telephony to H.323 calls. If set to 0, then RTP data is not generated by the Vega until the CONNECT message is

FXS/EXO	BRI	E/T1	H323	SIP	Section/Parameter	Activate	Range	Comments
								received from the H.323 interface. If set to 1, then RTP data is generated as soon as the H.323 protocol negotiations allow.
					[http]			
✓	✓	✓	✓	✓	https_ip=0.0.0.0		IP address/ host name	IP address for https server (for put, get and cron)
✓	✓	✓	✓	✓	https_port=443		1 .. 65535	IP port number for https server (for put, get and cron)
✓	✓	✓	✓	✓	ip=0.0.0.0		IP address/ host name	IP address for http server (for put, get and cron)
✓	✓	✓	✓	✓	lan_profile=1		0 .. 10	Lan profile for http server access
✓	✓	✓	✓	✓	ping_test=0		0 or 1	Do a ping test before accessing http server?
✓	✓	✓	✓	✓	port=80		1 .. 65535	IP port number for http server (for put, get and cron)
✓	✓	✓	✓	✓	timeout=30		1 .. 60	http timeout
					[http_server]			
✓	✓	✓	✓	✓	enable=1		0 .. 1	Enable http access to Vega web browser
✓	✓	✓	✓	✓	lan_profile=1		1 .. 10	Lan profile to use for HTTP / HTTPS web browser access
✓	✓	✓	✓	✓	port=80		1 .. 65535	IP Port number on which Vega will accept web browser traffic
					[https]			
✓	✓	✓	✓	✓	port=443	P,IMM	1 .. 65535	IP Port number on which Vega will accept HTTPS web browser traffic

FXS/EXO	BRI	E/T1	H 3 2 3	S I P	Section/Parameter	Activate	Range	Comments
					[lan]			LAN parameters
✓	✓	✓	✓	✓	bridge_mode=1		0 or 1	Default = 1 for Europa, = 0 for other products  0: Vega LAN interfaces are LAN 1 and LAN 2 - each interface (if used) must be in a separate IP subnet  1: Vega LAN interfaces are bridged, so that traffic seen 1 side is duplicated the other - used for Vega traffic over network traffic prioritisation.  See also 'IN45-Vega_Voice_Prioritisation' available in the technical documentation section of <a href="http://www.VegaAssist.com">www.VegaAssist.com</a>
✓	✓	✓	✓	✓	<a href="#">file_transfer_method</a> =TFTP	IMM	FTP / TFTP / http / https	This config parameter specifies the default method used for file transfer when the user does not explicitly specify the desired method.
✓	✓	✓	✓	✓	lan_profile=1		0 to 10	Lan profile to use for LAN accesses which do not have a more specific lan_profile
✓	✓	✓	✓	✓	name=this_hostame	S/R	length<256	Host name (must not contain spaces; use _ or -)
					[lan.gateway]			
✓	✓	✓	✓	✓	dhcp_if=1		1 or 2	1..2 - Lan interface to get DHCP IP address from  0 - do not use DHCP to get gateway IP
✓	✓	✓	✓	✓	ip=0.0.0.0	P,S/R	IP address/ host name	Default lan gateway IP/hostname (0.0.0.0 for none)
					[lan.if.1]			
✓	✓	✓	✓	✓	ip=0.0.0.0	P,S/R	IP address	IP address
✓	✓	✓	✓	✓	max_tx_rate=0		0..100000	0: turn off bandwidth handling  1..100000: Limit outgoing bandwidth to this value kbps.  See also 'IN45-Vega_Voice_Prioritisation' available in the technical documentation section of <a href="http://www.VegaAssist.com">www.VegaAssist.com</a>
✓	✓	✓	✓	✓	subnet=255.255.255.0	P,S/R	IP mask	Subnet mask
✓	✓	✓	✓	✓	use_apipa=1	S/R	0 or 1	Enable Vega to select a 169.254.xxx.yyy address if no DHCP IP address is supplied when asked for. (Interoperates with APIPA created IP addresses on PCs)
✓	✓	✓	✓	✓	use_dhcp=1	P,S/R	0 or 1	0 = use static configurations  1 = use DHCP server on this interface to set up IP values for Vega IP address and subnet, and optionally dns, lan gateway, ntp and tftp addresses
					[lan.if.1.dhcp]			DHCP parameters
✓	✓	✓	✓	✓	get_dns=1		0 or 1	If get_dns=1 and use_dhcp=1 and dns.dhcp_if =

FXS/EXO	BRI	E/T1	H323	SIP	Section/Parameter	Activate	Range	Comments
								this interface, then get DNS address from the DHCP server on this interface
✓	✓	✓	✓	✓	get_gateway=1		0 or 1	If get_gateway=1 and use_dhcp=1 then get LAN gateway address from the DHCP server on this interface
✓	✓	✓	✓	✓	get_ntp=1		0 or 1	If get_ntp=1 and use_dhcp=1 and ntp.dhcp_if = this interface, then get NTP server address from the DHCP server on this interface
✓	✓	✓	✓	✓	get_tftp=1		0 or 1	If get_tftp=1 and use_dhcp=1 and tftp.dhcp_if = this interface, then get TFTP server address from the DHCP server on this interface
					<a href="#">[lan.if.1.nat]</a>			
✓	✓	✓	✓	✓	enable=0	APPLY	0 or 1	Disable or enable NAT handling on the Vega
✓	✓	✓	✓	✓	private_subnet_list_index=1	APPLY	1 to 255	Select a list of subnets that are the local subnets, i.e. points to lan.private_subnet_list.x
					<a href="#">[lan.if.1.nat.profile.1]</a>			
✓	✓	✓	✓	✓	external_ip=0.0.0.0	APPLY	0 to 65535	Public IP address of NAT server
✓	✓	✓	✓	✓	port_list_index=0	APPLY	0 to 255	Index into lan.nat.port_list.x - associates that set of port_ranges to this external IP address
					<a href="#">[lan.if.1.phy]</a>			LAN - physical layer config
✓	✓	✓	✓	✓	full_duplex=0	P,S/R	0 or 1	Allow full duplex mode to be used on the LAN if other end supports it
✓	✓	✓	✓	✓	10baset=1	P,S/R	0 or 1	Allow 10 Mbps operation
✓	✓	✓	✓	✓	100basetx=1	P,S/R	0 or 1	Allow 100 Mbps operation
					<a href="#">[lan.if.1.8021q]</a>			802.1p/q enable
✓	✓	✓	✓	✓	accept_non_tagged=1	APPLY	0 or 1	Accept non 802.1 LAN packets as well as 802.1 LAN packets
✓	✓	✓	✓	✓	enable=0	APPLY	0 or 1	Enable 802.1 p/q operation
					<a href="#">[lan.localDNS.1]</a>			LAN - local DNS name table
✓	✓	✓	✓	✓	ip=127.0.0.1	APPLY	IP address	IP address of this device
✓	✓	✓	✓	✓	name=loopback	APPLY	length<32	Name of this device
					<a href="#">[lan.localDNSSRV.1]</a>			LAN - local DNSSRV name table
✓	✓	✓		✓	enable=0	APPLY	0, 1	Enable or disale use of local DNSSRV look ups
✓	✓	✓		✓	service_name=sip._udp.new_dnssrv	APPLY	Character String	Name of local DNSSRV record. Any DNSSRV record lookups will check this list first before sending to external DNS servers

FXS/EXO	BRI	E/T1	H 3 2 3	S I P	Section/Parameter	Activate	Range	Comments
					<a href="#">[lan.localDNSSRV.1.srvrec.1]</a>			
✓	✓	✓		✓	ipname=0.0.0.0	APPLY	IP address	IP address for first DNSSRV record entry
✓	✓	✓		✓	port=0	APPLY	0 - 65535	Port to send the SIP messaging.
✓	✓	✓		✓	priority=1	APPLY	1 - 1000	Relative priority of this record
✓	✓	✓		✓	weight=0	APPLY	0 - 10000	relative weight of this record
					<a href="#">[lan.nat.port_entry.1]</a>			
✓	✓	✓	✓	✓	external_port_min=0	APPLY	0 to 65535	Start of NATed port range on server
✓	✓	✓	✓	✓	internal_port_range_index=0	APPLY	0 to 40	Index into _advanced.lan.port_range.x - the range of IP port numbers that map onto this NATed range
✓	✓	✓	✓	✓	name=port_name	APPLY	length<32	Name - for self documentation purposes
					<a href="#">[lan.nat.port_list.1]</a>			
✓	✓	✓	✓	✓	list=all	APPLY	all, or x,y,z	all - select all lan.nat.port_entry.x x,y,z - a comma separated list of nat port entries (lan.nat.port_entry.?)
✓	✓	✓	✓	✓	name=default_port_list	APPLY	length<32	Name - for self documentation purposes

FXS/EXO	BRI	E/T1	H323	SIP	Section/Parameter	Activate	Range	Comments
					<a href="#">[lan.private_subnet.1]</a>			First of up to 40 subnet definitions
✓	✓	✓	✓	✓	ip=0.0.0.0	APPLY	IP address	Base IP address of subnet
✓	✓	✓	✓	✓	name=subnet_name	APPLY	length<32	Name - for self documentation purposes
✓	✓	✓	✓	✓	subnet=255.255.255.0	APPLY	Subnet mask	Subnet mask of this subnet
					<a href="#">[lan.private_subnet_list.1]</a>			
✓	✓	✓	✓	✓	list=all	APPLY	all, or x,y,z	all - select all lan.private.subnet.x x,y,z - a comma separated list of local subnet definitions (lan.private.subnet.?)
✓	✓	✓	✓	✓	name=default_subnet_list	APPLY	length<32	Name - for self documentation purposes
					<a href="#">[lan.static_route.1]</a>			Static Routes
✓	✓	✓	✓	✓	dest=0.0.0.0		IP address	Base IP address of destination subnet
✓	✓	✓	✓	✓	enable=0		0 or 1	Disable / Enable this Static Route entry
✓	✓	✓	✓	✓	gateway=0.0.0.0		IP address	IP address to send packets to in order to get to the 'dest' subnet
✓	✓	✓	✓	✓	subnet=255.255.255.0		IP mask	Subnet mask of the destination subnet (i.e. defines how many IP addresses there are in the destination subnet)
					<a href="#">[lan_profile.1]</a>			First of 10 possible lan profiles
✓	✓	✓	✓	✓	lan_interface=1		0, 1, 2	Specifies which physical LANs are included in this profile  0 means both LAN interfaces 1 and 2
✓	✓	✓	✓	✓	name=LAN_1		Length<32, no spaces	Name of LAN profile - for self documentation and pull down selection
✓	✓	✓	✓	✓	qos_profile=1		0 to 10	Qos profile to use as default or this LAN profile
					<a href="#">[logger]</a>			Event/billing logger/console
✓	✓	✓	✓	✓	bill_warn_threshold=90	APPLY	1-99	% bill log full to generate alert message
✓	✓	✓	✓	✓	DST_adjust=1	APPLY	0 / 1	0: use base local time for Caller ID time 1: use Daylight Saving Time for Caller ID time
✓	✓	✓	✓	✓	max_billings=100	APPLY	10-300	Max number of messages in billing log buffer
✓	✓	✓	✓	✓	max_messages=100	APPLY	10-300	Max number of messages in circular event log buffer
✓	✓	✓	✓	✓	prompt=%n%p>	APPLY	Length<32	Obsolete parameter - no longer used



FXS/EXO	BRI	E/T1	H323	SIP	Section/Parameter	Activate	Range	Comments
					<a href="#">[logger.radius]</a>			Radius Accounting CDR handling
8	8	8	8	8	lan_profile=1		0 .. 10	Lan profile to use for Radius
✓	✓	✓	✓	✓	max_retry_time=4000	APPLY	1 to 40000	Maximum retry timer for retransmissions (milliseconds)
✓	✓	✓	✓	✓	name=this_radius_hostname	APPLY	Length <= 31 characters	NAS (Network Access Server - gateway) identifier
✓	✓	✓	✓	✓	retries=4	APPLY	1 .. 100	Max retries used to send a specific accounting message
✓	✓	✓	✓	✓	retry_time=500	APPLY	1 .. 5000	Initial timeout before first retry (milliseconds) ... time doubles for each retry (but limits at max_retry_time)
✓	✓	✓	✓	✓	window_size=10	APPLY	1 .. 256	Maximum number of accounting messages that can be sent to the server before receiving a response.
					<a href="#">[logger.radius.attributes]</a>			Radius Accounting CDR handling
✓	✓	✓	✓	✓	overload_session_id=cisco_compatible_format	APPLY	vega_format, cisco_compatible_format, cisco_vsa or off	Select desired format of Radius Accounting record - overloaded acct_session_id - Vega format - overloaded acct_session_id - Cisco compatible format - Vendor Specific Attributes, Cisco compatible format

FXS/FXO	BRI	E/T1	H 3 2 3	S I P	Section/Parameter	Activate	Range	Comments
					<a href="#">[logger.radius.attributes.accounting]</a>			Radius Accounting CDR handling (RFC 2139) (Radius TYPE fields 40 to 51)
✓	✓	✓	✓	✓	acct_status_type=1	APPLY	0 or 1	1 = include record type, i.e. indicate Accounting on/off for registration/de-registration records and Start/Stop for call records  Radius TYPE = 40
✓	✓	✓	✓	✓	acct_delay_time=1	APPLY	0 or 1	1 = include indication of delay incurred before this record was sent  Radius TYPE = 41
✓	✓	✓	✓	✓	acct_input_octets=1	APPLY	0 or 1	1 = include count of RTP media bytes received for this call - only available in STOP records, and if the QOS statistics module is enabled  Radius TYPE = 42
✓	✓	✓	✓	✓	acct_output_octets=1	APPLY	0 or 1	1 = include count of RTP media bytes sent for this call - only available in STOP records, and if the QOS statistics module is enabled  Radius TYPE = 43
✓	✓	✓	✓	✓	acct_session_id=1	APPLY	0 or 1	1 = include session ID ... this is the field that contains the CDR information when overload_session_id = vega_format or cisco_compatible_format  Radius TYPE = 44
✓	✓	✓	✓	✓	acct_session_time=1	APPLY	0 or 1	1 = include session time field = duration of call in seconds  Radius TYPE = 46
✓	✓	✓	✓	✓	acct_terminate_cause=1	APPLY	0 or 1	1 = include call termination reason in STOP records  Radius TYPE = 49

FXS/EXO	BRI	E/T1	H323	SIP	Section/Parameter	Activate	Range	Comments
					<a href="#">[logger.radius.attributes.ci_sco_vsa]</a>			Radius Accounting CDR handling - Vendor Specific Attributes
✓	✓	✓	✓	✓	call_origin=1	APPLY	0 or 1	1 = include indication of call origin, either Originate or Answer
✓	✓	✓	✓	✓	call_type=1	APPLY	0 or 1	1 = include indication of call type, either Telephony or VoIP
✓	✓	✓	✓	✓	connect_time=1	APPLY	0 or 1	1 = include connection time for this call leg - in NTP format
✓	✓	✓	✓	✓	connection_id=1	APPLY	0 or 1	1 = include unique call ID (4 word hex value consisting of call context, connection time in seconds, disconnection time in seconds and IP address)
✓	✓	✓	✓	✓	disconnect_cause=1	APPLY	0 or 1	1 = include Q.850 disconnect cause code
✓	✓	✓	✓	✓	disconnect_time=1	APPLY	0 or 1	1 = include disconnection time for this call leg - in NTP format
✓	✓	✓	✓	✓	gateway_id=1	APPLY	0 or 1	1 = include name specified in logger.radius.name
✓	✓	✓	✓	✓	remote_gateway_id=1	APPLY	0 or 1	1 = include IP address of the remote endpoint
✓	✓	✓	✓	✓	setup_time=1	APPLY	0 or 1	1 = include setup time for this call leg - in NTP format
✓	✓	✓	✓	✓	voice_quality=1	APPLY	0 or 1	1 = include voice quality field (Voice Quality field is reserved for future use)
					<a href="#">[logger.radius.attributes.standard]</a>			Radius Accounting CDR handling (RFC 2138) (Radius TYPE fields 1 to 39 and 60 +)
✓	✓	✓	✓	✓	called_station_id=1	APPLY	0 or 1	1 = include E164 number of the called party Radius TYPE = 30
✓	✓	✓	✓	✓	calling_station_id=1	APPLY	0 or 1	1 = include E164 number of the calling party Radius TYPE = 31
✓	✓	✓	✓	✓	nas_identifier=1	APPLY	0 or 1	1 = include name specified in logger.radius.name Radius TYPE = 32
✓	✓	✓	✓	✓	nas_ip_address=1	APPLY	0 or 1	1 = include IP address of this gateway Radius TYPE = 4
✓	✓	✓	✓	✓	nas_port=1	APPLY	0 or 1	1 = include interface number (IF:) that this call leg is traversing Radius TYPE = 5
✓	✓	✓	✓	✓	nas_port_type=1	APPLY	0 or 1	1 = include interface type, Ethernet for LAN interface, Async for analogue POTS interfaces and ISDN-sync for ISDN interfaces Radius TYPE = 61
✓	✓	✓	✓	✓	user_name=1	APPLY	0 or 1	1 = include name of the user ... in priority order this is populated with: pre-routed NAME value, pre-routed NAMEC value , post-routed NAMEC value, pre-routed TELC , post-routed TELC value, TEL Radius TYPE = 1

FXS/EXO	BRI	E/T1	H323	SIP	Section/Parameter	Activate	Range	Comments
					<a href="#">[logger.radius.server.1]</a>			First of up to 2 radius servers
✓	✓	✓	✓	✓	auth_port=1812	APPLY	1 to 65535	IP port (on the radius server) to send authentication message to.
✓	✓	✓	✓	✓	enable=0	APPLY	0 or 1	Disable or enable use of this radius server
✓	✓	✓	✓	✓	ipname=0.0.0.0	APPLY		IP address or DNS resolvable name of the radius server
✓	✓	✓	✓	✓	port=1813	APPLY	1 to 65535	IP port (on the radius server) to send radius data to
✓	✓	✓	✓	✓	registration=1	APPLY	0 or 1	0: do not register with radius server 1: register with radius server (send accounting on/off records at the beginning and end of billing sessions)
✓	✓	✓	✓	✓	secret=testing123	APPLY	Length <= 31 characters	Shared secret encryption string - must be configured on the radius server too.
					<a href="#">[logger.syslog]</a>			Up to 5 entries allowed
8	8	8	8	8	lan_profile=1		0 .. 10	Lan profile to use for syslog
					<a href="#">[logger.syslog.server.1]</a>			Up to 5 entries allowed
✓	✓	✓	✓	✓	ip=0.0.0.0		IP address	IP address of SYSLOG server
✓	✓	✓	✓	✓	name=DEFAULT_SYSLOG		length<=32	Name - for self documentation purposes (must not contain spaces; use _ or -)
✓	✓	✓	✓	✓	port=514		1 to 65535	IP port to send SYSLOG messages to
					<a href="#">[logger.syslog.server.1.option]</a>			
✓	✓	✓	✓	✓	billing=1		0 or 1	Send billing records to this SYSLOG server
✓	✓	✓	✓	✓	console=1		0 or 1	Send console activity (web and CLI) records to this SYSLOG server
✓	✓	✓	✓	✓	debug=0		0 or 1	Send debug records to this SYSLOG server
✓	✓	✓	✓	✓	logging=1		0 or 1	Send event log records to this SYSLOG server
✓	✓	✓	✓	✓	qos=0		0 or 1	Send qos records to this SYSLOG server - see also qos_profile.stats.syslog
					<a href="#">[media]</a>			
					<a href="#">[media.cap.1]</a>			
✓	✓	✓	✓	✓	codec=g7231		g7231, g729AnnexA, g729, g711Alaw64k, g711Ulaw64k, t38tcp, t38udp, octet	This capability ID specifies a specific codec
✓	✓	✓	✓	✓	index=1		1	Index into media.packet.<codec>.n for additional configuration

FXS/EXO	BRI	E/T1	H323	SIP	Section/Parameter	Activate	Range	Comments
					[media.capset.1]			
✓	✓	✓	✓	✓	name=voice			Capabilities set name - for self documentation purposes
✓	✓	✓	✓	✓	caps=6,2,3		List of indexes into media.cap	Specifies a list of codecs in this capability set  In SIP there are data g.711 codecs (profile 2) and a T.38 codec. Including these enable fax detection and if appropriate T.38 connectivity
					[media.control.1.dynamic_update]			See also sip.media_control_profile
✓	✓	✓		✓	enable=0	APPLY	0 or 1	0= Abide by the SDP when sending RTP  1= Send RTP traffic to the IP port (/IP address) that is sending the RTP to this gateway (for this call)
✓	✓	✓		✓	frequency=0	APPLY	0 to 200	How often (in packets) to look to see whether incoming RTP is coming from a different source  0= only check at start of RTP reception.  n = check every n <sup>th</sup> packet
✓	✓	✓		✓	ip_follow=0			0 = only follow IP port changes 1 = follow IP port and IP address changes
✓	✓	✓		✓	private_subnet_list_index=0	APPLY	0 or 1	Index into private subnet list. This list will define the valid set of IP addresses that can be followed.  To follow to any IP address, point the index to a list which contains "allow all".  Leaving the index set to 0 says that no IP addresses may be followed! Do not leave set to 0.
					[media.packet.gsm.1]			Config for specific codec - 2 profiles supported, 1 for Voice, 2 for Data connections
✓	✓	✓	✓	✓	out_of_band_DTMF=1	CALL	0 or 1	Enable/disable out of band DTMF
✓	✓	✓	✓	✓	packet_time=20	CALL	10/20/30	Preferred packet sampling size in milliseconds - make sure that this value is between packet_time_max and packet_time_min in dsp.g711Alaw64k
✓	✓	✓	✓	✓	VADU_enable_flag=0	CALL	0 or 1	Enable/disable silence suppression (voice activity detection) mode
					[media.packet.g711Alaw64k.1]			Config for specific codec - 2 profiles supported, 1 for Voice, 2 for Data connections
✓	✓	✓	✓	✓	out_of_band_DTMF=1	CALL	0 or 1	Enable/disable out of band DTMF
✓	✓	✓	✓	✓	packet_time=30	CALL	10/20/30	Preferred packet sampling size in milliseconds - make sure that this value is between

FXS/EXO	BRI	E/T1	H 3 2 3	S I P	Section/Parameter	Activate	Range	Comments
								packet_time_max and packet_time_min in dsp.g711Alaw64k
✓	✓	✓	✓	✓	VADU_enable_flag=0	CALL	0 or 1	Enable/disable silence suppression (voice activity detection) mode
					[media.packet.g711Alaw64k.2]			Config for specific codec - 2 profiles supported, 1 for Voice, 2 for Data connections
✓	✓	✓	✓	✓	out_of_band_DTMF=0	CALL	0 or 1	Enable/disable out of band DTMF
✓	✓	✓	✓	✓	packet_time=20	CALL	10/20/30	Preferred packet sampling size in milliseconds - make sure that this value is between packet_time_max and packet_time_min in dsp.g711Alaw64k
✓	✓	✓	✓	✓	VADU_enable_flag=0	CALL	0 or 1	Enable/disable silence suppression (voice activity detection) mode
					[media.packet.g711Ulaw64k.1]			Config for specific codec - 2 profiles supported, 1 for Voice, 2 for Data connections
✓	✓	✓	✓	✓	out_of_band_DTMF=1	CALL	0 or 1	Enable/disable out of band DTMF
✓	✓	✓	✓	✓	packet_time=20	CALL	10/20/30	Preferred packet sampling size in milliseconds - make sure that this value is between packet_time_max and packet_time_min in dsp.g711Ulaw64k
✓	✓	✓	✓	✓	VADU_enable_flag=0	CALL	0 or 1	Enable/disable silence suppression (voice activity detection) mode
					[media.packet.g711Ulaw64k.2]			Config for specific codec - 2 profiles supported, 1 for Voice, 2 for Data connections
✓	✓	✓	✓	✓	out_of_band_DTMF=0	CALL	0 or 1	Enable/disable out of band DTMF
✓	✓	✓	✓	✓	packet_time=20	CALL	10/20/30	Preferred packet sampling size in milliseconds - make sure that this value is between packet_time_max and packet_time_min in dsp.g711Ulaw64k
✓	✓	✓	✓	✓	VADU_enable_flag=0	CALL	0 or 1	Enable/disable silence suppression (voice activity detection) mode
					[media.packet.g729AnnexA.1]			Config for specific codec - currently only 1 profile supported
✓	✓	✓	✓	✓	out_of_band_DTMF=1	CALL	0 or 1	Enable/disable out of band DTMF
✓	✓	✓	✓	✓	packet_time=20	CALL	10/20/30/40/ 50/60/70/80	Preferred packet sampling size in milliseconds - make sure that this value is between packet_time_max and packet_time_min in dsp.g729AnnexA
✓	✓	✓	✓	✓	VADU_enable_flag=0	CALL	0 or 1	Enable/disable silence suppression (voice activity detection) mode

FXS/EXO	BRI	E/T1	H 3 2 3	S I P	Section/Parameter	Activate	Range	Comments
					[media.packet.g729.1]			Config for specific codec - currently only 1 profile supported
✓	✓	✓	✓	✓	out_of_band_DTMF=1	CALL	0 or 1	Enable/disable out of band DTMF
✓	✓	✓	✓	✓	packet_time=20	CALL	10/20/30/40/50/60/70/80	Preferred packet sampling size in milliseconds - make sure that this value is between packet_time_max and packet_time_min in dsp.g729
✓	✓	✓	✓	✓	VADU_enable_flag=0	CALL	0 or 1	Enable/disable silence suppression (voice activity detection) mode
					[media.packet.g7231.1]			Config for specific codec - currently only 1 profile supported
✓	✓	✓	✓	✓	bit_rate=6.3		5.3 or 6.3	Select the bitrate for Vega to use when transmitting G.723.1 audio
✓	✓	✓	✓	✓	out_of_band_DTMF=1	CALL	0 or 1	Enable/disable out of band DTMF
✓	✓	✓	✓	✓	packet_time=30	CALL	30/60	Preferred packet sampling size in milliseconds - make sure that this value is between packet_time_max and packet_time_min in dsp.g7231
✓	✓	✓	✓	✓	VADU_enable_flag=0	CALL	0 or 1	Enable/disable silence suppression (voice activity detection) mode
					[media.packet.octet.1]			
✓	✓	✓	✓	✓	packet_time=20		10 or 20	Octet stream packet size
✓	✓	✓	✓	✓	rtp_payload_type=98		96 to 127	Payload ID for octet data stream
					[media.packet.t38tcp.1]			Config for specific codec - currently only 1 profile supported
✓	✓	✓	✓	✓	max_rate=144	CALL	24/48/72/96/120/144	Preferred maximum fax connection rate - make sure that this value is between rate_max and rate_min in dsp.t38
✓	✓	✓	✓	✓	tcf=local	CALL	local transferred	T38 fax modem training can either be handled locally or transferred across the VoIP link. Typically local is used with t38tcp and transferred with t38udp
					[media.packet.t38udp.1]			Config for specific codec - currently only 1 profile supported
✓	✓	✓	✓	✓	max_rate=144	CALL	24/48/72/96/120/144	Preferred maximum fax connection rate - make sure that this value is between rate_max and rate_min in dsp.t38
✓	✓	✓	✓	✓	tcf=transferred	CALL	local transferred	T38 fax modem training can either be handled locally or transferred across the VoIP link. Typically local is used with t38tcp and transferred with t38udp
					[namespace]			
✓	✓	✓		✓	selected_namespace=off		Off,	NameSpace to use for initiated SIP calls and

FXS/EXO	BRI	E/T1	H323	SIP	Section/Parameter	Activate	Range	Comments
							namespace.1, namespace.2 up to namespace.6	NameSpace to compare with for received calls
					[namespace.1]			1 <sup>st</sup> entry of up to 6 entries (1 to 3 are read only)
✓	✓	✓		✓	name=dsn		dsn	NameSpace name
✓	✓	✓		✓	Priorities=routine,priority, immediate,flash,flash- override		routine,prior ity,immediate ,flash,flash- override	NameSpace priorities - lowest priority to highest priority order
✓	✓	✓		✓	Type=fixed		Fixed	Fixed = Read Only.
					[namespace.2]			2 <sup>nd</sup> entry of up to 6 entries (1 to 3 are read only)
✓	✓	✓		✓	name=drsn		drsn	NameSpace name
✓	✓	✓		✓	priorities=routine,priority, immediate,flash,flash- override,flash-override- override		routine,prior ity,immediate ,flash,flash- override,flas h-override- override	NameSpace priorities - lowest priority to highest priority order
✓	✓	✓		✓	type=fixed		Fixed	Fixed = Read Only.
					[namespace.3]			3 <sup>rd</sup> entry of up to 6 entries (1 to 3 are read only)
✓	✓	✓		✓	name=q735		Q735	NameSpace name
✓	✓	✓		✓	priorities=4,3,2,1,0		4,3,2,1,0	NameSpace priorities - lowest priority to highest priority order
✓	✓	✓		✓	type=fixed		Fixed	Fixed = Read Only.
					[namespace.4]			4 <sup>th</sup> entry of up to 6 entries (4 to 6 are user configurable)
✓	✓	✓		✓	name=user		NameSpace name 1 to 31 characters	NameSpace name
✓	✓	✓		✓	priorities=4,3,2,1,0		Comma separated list, 1 to 255 characters	NameSpace priorities - lowest priority to highest priority order
✓	✓	✓		✓	type=user-defined		user-defined	user-defined = configurable
					[ntp]			
✓	✓	✓	✓	✓	dhcp_if=1		1 or 2	1..2 - Lan interface to get DHCP IP address from - if DHCP for ntp is enabled in that interface  0 - do not use DHCP to get ntp IP
✓	✓	✓	✓	✓	<a href="#">ip=0.0.0.0</a>	APPLY	IP address/	Network time protocol server/hostname (0.0.0.0 for none)



FXS/EXO	BRI	E/T1	H323	SIP	Section/Parameter	Activate	Range	Comments
							host name	
✓	✓	✓	✓	✓	lan_profile=1	S/R	0 to 10	Lan profile to use for ntp accesses
✓	✓	✓	✓	✓	ping_test=0	APPLY	0 / 1	When enabled the Vega will attempt to ping the NTP server before querying the time. If the ping fails the Vega will not query the NTP server for the time. When disabled the Vega will immediately send the NTP query to the server.
✓	✓	✓	✓	✓	<a href="#">poll_interval=1200</a>	APPLY	0 to 99999	Interval for polling time server: HHHMM (max 999hrs + 99 mins)
✓	✓	✓	✓	✓	port=123	APPLY	1 to 65535	IP port number for NTP
					<b>[phone_context]</b>			Phone context section
✓	✓	✓		✓	<b>[phone_context.local.1]</b>			
					enable=1		0 or 1	Enable phone-context inclusion in FROM header (globally)
					<b>[phone_context.local.1.pc.1]</b>			
✓	✓	✓		✓	NPI=any		any/unknown /isdn_telephony/data/telex /national/ private	Use specific phone-context when Numbering plan information received in ISDN SETUP matches defined NPI value.
✓	✓	✓		✓	TON=any		any/unknown/i nternational/ national/netw ork_specific/ subscriber/ab breviated	Use specific phone-context when Type Of Number information received in ISDN SETUP matches defined TON value.
✓	✓	✓		✓	enable=0		0 or 1	Enable / disable specific phone-context defintion
✓	✓	✓		✓	name=local_phone.1.com		String up to 63 chars	Name of specific phone-context defintion
					<b>[phone_context.remote.1]</b>			
✓	✓	✓		✓	enable=1		0 or 1	Enable phone-context inclusion in TO header (globally)
					<b>[phone_context.remote.1.pc.1]</b>			
✓	✓	✓		✓	NPI=any		any/unknown /isdn_telephony/data/telex /national/ private	Use specific phone-context when Numbering plan information received in ISDN SETUP matches defined NPI value.
✓	✓	✓		✓	TON=any		any/unknown/i nternational/ national/netw ork_specific/ subscriber/ab breviated	Use specific phone-context when Type Of Number information received in ISDN SETUP matches defined TON value.
✓	✓	✓		✓	enable=0		0 or 1	Enable / disable specific phone-context defintion
✓	✓	✓		✓	name=remote_phone.1.com		String up to 63 chars	Name of specific phone-context defintion
					<b>[planner]</b>			Dial planner section
✓	✓	✓		✓	allow_tx_overlap=1		0 or 1	When enabled allow the Vega to originate calls using overlap dialling, if disabled use enbloc.

FXS/EXO	BRI	E/T1	H 3 2 3	S I P	Section/Parameter	Activate	Range	Comments
					<a href="#">[planner.cpg.1]</a>			First of up to 40 Call Presentation Groups - CPGs define virtual interface IDs which define which physical interfaces to send calls to, and in what order. N.B. do not use CPG interface IDs in source expressions of dial plans.
✓	✓	✓	✓	✓	cause=17		comma separated list of cause codes	Comma separated list of Q.850 clear-down cause codes that will cause the Vega to try the next interface in the dest list.
✓	✓	✓	✓	✓	dest=IF:0101 IF:0102 IF:0103 IF:0104 IF:0105 IF:0106 IF:0107 IF:0108		list of interfaces, separated by ' '	Group of destination (physical) interfaces to try when placing a call (list in order of use; physical interfaces may appear in the list more than once if required)
✓	✓	✓	✓	✓	dest_timeout=180		1 .. 10000	Time in seconds to try each interface - after the timeout do as specified in dest_timeout_action
✓	✓	✓	✓	✓	dest_timeout_action=hangup		hangup or try_next_dest	hangup - if a call times out (dest_timeout expires) then exit the CPG - if the calling dial plan is in a call re-presentation group, the Vega will re-present the call, otherwise the call will clear.  try_next_dest - if a call times out (dest_timeout expires) then try the next entry in the CPG
✓	✓	✓	✓	✓	enable=0		0 or 1	Disable / enable
✓	✓	✓	✓	✓	interface=1001		interface ID 1 to 63 characters	(Virtual) Interface ID
✓	✓	✓	✓	✓	max_dest_attempts=8		1 to 120	How many different destinations to check before failing the call (max_dest_attempts is designed to allow only a subset of the dest interfaces to be tried; whatever the value of max_dest_attempts the Vega will only try each entry in the dest list once - though the same physical interface may appear more than once in the dest list)
✓	✓	✓	✓	✓	name=default		length<32	Group name - for self documentation purposes
✓	✓	✓	✓	✓	seq_mode=round_robin		linear_up, round_robin or random	How to use dest list:  linear_up - from first to last,  round_robin - each call tries the next interface as its first interface, working from the first entry in the list up to the last entry and then to the first entry again  random - random choice of interface
					<a href="#">[planner.group]</a>			Groups for redundant routes
					<a href="#">[planner.group.1]</a>			Up to 10 planner.group.x
✓	✓	✓	✓	✓	name=default	S/R	length<32	Group name - for self documentation purposes
✓	✓	✓	✓	✓	active_times=0000-2359			Disable dial plans in this group outside the active times.

FXS/EXO	BRI	E/T1	H 3 2 3	S I P	Section/Parameter	Activate	Range	Comments
								Start HHMM to end HHMM - times are inclusive
✓	✓	✓	✓	✓	cause=0	S/R	comma separated list of values 0 to 127	Applicable cause code list for this group
✓	✓	✓	✓	✓	lan=off		off active inactive	Do not disable dial plans in this group due to LAN status  Disable dial plans in this group if the LAN is inactive  Disable dial plans in this group if the LAN is active
					<a href="#">[planner.post_profile]</a>			
✓	✓	✓	✓	✓	enable=0	APPLY	0 or 1	disable or enable all post_profile entries
					<a href="#">[planner.post_profile.plan.1]</a>			Up to 20 plans
✓	✓	✓	✓	✓	name=International	APPLY	length<32	Plan name - for self documentation purposes
✓	✓	✓	✓	✓	enable=0	APPLY	0 or 1	disable or enable this post_profile entry
✓	✓	✓	✓	✓	srce= TEL:00<.*>	APPLY	IF: TEL: TA: NAME: TAC: TELC: DISP:	
✓	✓	✓	✓	✓	dest= TYPE:international	APPLY	TYPE: PLAN: TYPEC: PLANC: PRESC: SCRNC: TELC: DISP:	TYPE: populate the called party number "Type Of Number" field with: national, International, network_specific, subscriber, abbreviated, and unknown PLAN: populate the called party number "Numbering Plan Information" field with: isdn_telephony, data, telex, national, private, and unknown TYPEC: populate the calling party number "Type Of Number" field with: national, international, network_specific, subscriber, abbreviated, or unknown PLANC: populate the calling party number "Numbering Plan Information" field with: isdn_telephony, data, telex, national, private, or unknown PRESC: populate the calling party PRESENTATION indicator with: allowed, not_available, or restricted SCRNC: populate the calling party SCREENING indicator with: failed <sup>4</sup> , not_screened, passed, or network TELC: caller ID (ANI)

<sup>4</sup> 'failed' is not a valid ETSI value (even though it is defined in Q.931)

FXS/EXO	BRI	E/T1	H 3 2 3	S I P	Section/Parameter	Activate	Range	Comments
								DISP: display field
					<b>[planner.profile.1]</b>			Profile 1 (up to 25 profiles)
✓	✓	✓	✓	✓	name=new_profile	APPLY	length<32	Profile name - for self documentation purposes
✓	✓	✓	✓	✓	enable=1	APPLY	0 or 1	disable / enable
					<b>[planner.profile.1.plan.1]</b>			First plan (up to 50 plans per profile)
✓	✓	✓	✓	✓	name=new_plan	APPLY	length<32	Plan name - for self documentation purposes
✓	✓	✓	✓	✓	srce=TEL:<...><.*>	APPLY	IF: TEL: TA: NAME: TAC: TELC: DISP:	Source (incoming) expression to match (see section 8)
✓	✓	✓	✓	✓	dest=IF:<1>,TEL:<2>	APPLY	IF: TEL: TA: NAME: TAC: TELC: DISP: QOS: CAPDESC: NAMEC: TYPE: TYPEC: PLAN: PLANC: SCRNC: PRESC:	Destination (outgoing) expression to create (see section 8)
✓	✓	✓	✓	✓	group=0	APPLY	index, or zero	Used to group dial plans together, and also act as an index into <a href="#">planner.group</a> parameters to be used with this plan
✓	✓	✓	✓	✓	cost=0	APPLY	0-9	Plan cost index
					<b>[planner.whitelist]</b>			Whitelist section - up to 50 entries
✓	✓	✓	✓	✓	enable=0	APPLY	0 or 1	disable / enable whitelist security

FXS/FXO	BRI	E/T1	H 3 2 3	S I P	Section/Parameter	Activate	Range	Comments
					[planner.whitelist.1]			First whitelist entry (up to 50 entries allowed)
✓	✓	✓	✓	✓	name=default	IMM	length<32	Name of this white list - for self documentation purposes
✓	✓	✓	✓	✓	number=IF:.*	APPLY	length<64	Expression defining who/where to accept calls from (see section <a href="#">8.13</a> )
					[pots]			POTS (telephone handset) config
					[pots.port.1]			
✓				✓	call_conference=off	APPLY	off, on	Enable or disable three way calling for this port
✓				✓	call_fwd_enable=on	APPLY	off, on	Enable or disable all types of call forward for this port
✓				✓	call_transfer=on	APPLY	off, on	Enable or disable call transfer for this port
✓				✓	call_waiting=off	APPLY	off, on	Enable or disable call waiting for this port
✓			✓	✓	callerid=off	APPLY	on or off	Caller ID enable/disable (for caller ID at start of call, and if the call waiting supplementary service is enabled when a call arrives mid call)
✓				✓	dnd_enable=on	APPLY	off, on	Enable or disable Do Not Disturb for this port
✓				✓	dnd_off_hook_deactivate=off	APPLY	off, on	on = Going off-hook on the phone connected to this port will deactivate DND for this port. off = going offh-ook on the phone connected to this port will have no affect on the status of DND.
✓				✓	dnd_response=instant_reject	APPLY		Control whether when DND is active the call is instantly rejected on the SIP side or whether ringing indication is provided
✓			✓	✓	enable=1	APPLY	0 or 1	disable / enable port  SIP: NOTE this does not disable the port registering with the SIP proxy; disable registration as well as disabling the port
✓			✓	✓	fx_profile=1		1 to 10	Hardware profile for this port (see _advanced.pots.fxs.y or _advanced.pots.fxo.y)
✓			✓	✓	lyr1=g711Alaw64k	APPLY	g711Alaw64k or g711Ulaw64k	Companding codec used on this port  DO NOT ALTER FROM FACTORY DEFAULT - this must match with the hardware on board.
✓			✓	✓	tx_gain=0	APPLY	0 or 1	0 - default gain setting in analogue transmit hardware  1 - apply additional gain in the analogue transmit hardware
					[pots.port.1.if.1]			
✓			✓	✓	dn=0101	APPLY	length<32	FXS dn = directory number, the Caller ID (ANI) associated with calls made from that telephony interface  FXO dn = directory number, the Caller ID (ANI) associated with calls made from that telephony interface - if caller ID reception

FXS/FXO	BRI	E/T1	H323	SIP	Section/Parameter	Activate	Range	Comments
								is turned off SIP units that register with a SIP Proxy: dn specifies the nn in the contact address nn@ip_address_of_vega
✓			✓	✓	interface=0101	APPLY	length<32	Interface for this group
✓			✓	✓	profile=1		1 to 10	POTS profile (pots.profile.x) to use to define profile for this interface
F X S			✓	✓	ring_index=1	APPLY	Index	Index to the distinctive (power) ring pattern to be used to ring attached phone <b>for FXS ports only</b> See <a href="#">_advanced.pots.ring.n</a>
✓			✓	✓	username=FXS1	APPLY	length<32	H.323: Name used in display field on calls originating from POTS interfaces SIP: Name section used for SIP proxy registration, and for all other SIP messages use in the From: field
					[pots.profile.1]			First of up to 10 POTS hardware profiles (currently up to 2 profiles are supported) Profile 1 is for FXS, profile 2 is for FXO
8.1 F X S			8.1	8.1	callerid_time=DST	APPLY	base or DST	Base: use base local time for Caller ID time DST: use Daylight Saving Time for Caller ID time
✓			✓	✓	callerid_type=off	APPLY	off/gr30-sdmf/gr30-mdmf/bt	Caller ID encoding method ( <b>for analogue only</b> ) NOTE: on an FXO unit, turning this to off does not stop the Vega waiting to receive the caller ID (after the first ring), to speed up call reception on FXO, also turn off caller ID per port:- pots.port.x.callerid=off
F X O			✓	✓	callerid_wait=6000	IMM	10 to 20000	Time (in milli seconds)that an FXO port will wait for the incoming caller ID after detecting an incoming power ring.
✓			✓	✓	dtmf_dial_digit=#	S/R	1 char * or #, 0 to 9, A to F, or Z	DTMF dial termination character - the DTMF character that indicates the dialled number is complete (overrides dtmf_dial_timeout) forcing the received number to be passed to the dial plan router (set to Z to disable this function)
✓			✓	✓	dtmf_dial_timeout=5	S/R	FXS: 1..999 FXO: 0..999	Time after last dialled digit is received that dialled number is forwarded to the dial plan router (in seconds)  In the FXO this therefore also specifies the duration that secondary dial tone is played for if no dialled digit is received.  FXS: 999 = no timeout used FXO: 0 = no secondary dial tone played
✓			✓	✓	line_busy_cause=17	APPLY	1 to 127	Cause code to be returned when POTS line is in use
✓			✓	✓	name=FXS_ports_profile	APPLY	Up to 32 chars	Name of profile, for self documentation

FXS/FXO	BRI	E/T1	H323	SIP	Section/Parameter	Activate	Range	Comments
					[pots.profile.2]			Profile 2 is for FXO
					... as per pots.profile.1, except line_busy_cause=34			
					[qos_profile]			
					[qos_profile.1]			QOS profile (up to 10 profiles are supported)
✓	✓	✓	✓	✓	name=default	APPLY	Length<=50	Name of this QOS profile - for self documentation purposes
					[qos_profile.1.tos]			Ethernet Type Of Service configuration
✓	✓	✓	✓	✓	default_priority=0x00	APPLY	0 to 255	default_priority is used for any LAN traffic not associated with either call signalling or call media.
✓	✓	✓	✓	✓	media_priority=0x00	APPLY	0 to 255	media_priority is used for media packets, ie audio RTP packets and T.38 packets
✓	✓	✓	✓	✓	signalling_priority=0x00	APPLY	0 to 255	signalling_priority is used for the VoIP signalling messages
					[qos_profile.1.8021q]			802.1 p/q QOS configuration
✓	✓	✓	✓	✓	default_priority=0	APPLY	0 to 7	default_priority is used for any LAN traffic not associated with either call signalling or call media.
✓	✓	✓	✓	✓	media_priority=0	APPLY	0 to 7	media_priority is used for media packets, ie audio RTP packets and T.38 packets
✓	✓	✓	✓	✓	signalling_priority=0	APPLY	0 to 7	signalling_priority is used for the VoIP signalling messages
✓	✓	✓	✓	✓	vlan_id=0	APPLY	0 to 4095	VLAN ID for all packets sent out using this profile
✓	✓	✓	✓	✓	vlan_name=Default	APPLY	Length<=50	Name of this 802.1 p/q QOS profile - for self documentation purposes
					[qos_profile.stats]			
✓	✓	✓	✓	✓	cdr_detail=low	IMM	low, medium, or high	Level of detail required in the QOS CDRs
✓	✓	✓	✓	✓	enable=0	IMM	0 or 1	Disable / enable QOS monitoring
✓	✓	✓	✓	✓	max_no_cdrs=100	S/R	10 to 100	QOS statistics buffer size. After the specified number of entries have been used, new entries will over-write the eldest ones.
✓	✓	✓	✓	✓	monitoring_interval=300	IMM	100 to 5000	Period (in media poll intervals) that statistics are collected. For engineering use only, do not change
✓	✓	✓	✓	✓	monitoring_threshold=50	IMM	10 to 80	Limit of percentage of media interrupt time that collecting QOS statistics is allowed to take. For engineering use only, do not change
✓	✓	✓	✓	✓	qos_warn_threshold=80	IMM	0 to 100	Percentage level of QOS CDR buffer capacity

FXS/EXO	BRI	E/T1	H 3 2 3	S I P	Section/Parameter	Activate	Range	Comments
								when a warning alarm is issued
					<a href="#">[qos_profile.stats.events.call]</a>			
					[qos_profile.stats.events.call.average_jitter]			
✓	✓	✓	✓	✓	enable=0	IMM	0 or 1	Enables the reporting of excessive average jitter
✓	✓	✓	✓	✓	threshold=50	IMM	1 to 200	This defines the level of jitter defined to be excessive (ms)
					[qos_profile.stats.events.call.jitter_buf_overflow]			
✓	✓	✓	✓	✓	enable=0	IMM	0 or 1	Enable the reporting of jitter buffer overflows
					[qos_profile.stats.events.call.jitter_buf_underflow]			
✓	✓	✓	✓	✓	enable=0	IMM	0 or 1	Enable the reporting of jitter buffer underflows
					[qos_profile.stats.events.call.packet_error_rate]			
✓	✓	✓	✓	✓	enable=0	IMM	0 or 1	Enables the reporting of excessive packet errors
✓	✓	✓	✓	✓	threshold_rate=5	IMM	1 to 100	This defines the level of packet errors defined to be excessive (%)
					[qos_profile.stats.events.call.packet_loss]			
✓	✓	✓	✓	✓	enable=0	IMM	0 or 1	Enables the reporting of excessive packet loss
✓	✓	✓	✓	✓	threshold_rate=5	IMM	1 to 100	This defines the level of packet loss defined to be excessive (%)
					[qos_profile.stats.events.call.pkt_playout_delay]			
✓	✓	✓	✓	✓	enable=0	IMM	0 or 1	Enables the reporting of excessive one way delay
✓	✓	✓	✓	✓	threshold=250	IMM	1 to 1000	This defines the level of one way delay defined to be excessive (ms)
					<a href="#">[qos_profile.stats.events.gateway]</a>			
					[qos_profile.stats.events.gateway.average_jitter]			
✓	✓	✓	✓	✓	enable=0	IMM	0 or 1	Enables the reporting of excessive average jitter



FXS/EXO	BRI	E/T1	H323	SIP	Section/Parameter	Activate	Range	Comments
✓	✓	✓	✓	✓	threshold=50	IMM	1 to 200	This defines the level of jitter defined to be excessive (ms)
					[qos_profile.stats.events.gateway.lan_link]			
✓	✓	✓	✓	✓	enable=0	IMM	0 or 1	Enables the reporting of lan link down and lan link recovery
					[qos_profile.stats.events.gateway.packet_loss]			
✓	✓	✓	✓	✓	enable=0	IMM	0 or 1	Enables the reporting of excessive packet loss
✓	✓	✓	✓	✓	threshold_rate=5	IMM	1 to 100	This defines the level of packet loss defined to be excessive (%)
					[qos_profile.stats.events.gateway.pkt_playout_delay]			
✓	✓	✓	✓	✓	enable=0	IMM	0 or 1	Enables the reporting of excessive one way delay
✓	✓	✓	✓	✓	threshold=250	IMM	1 to 1000	This defines the level of one way delay defined to be excessive (ms)
					[qos_profile.stats.report]			
✓	✓	✓	✓	✓	frequency=50	IMM	10 to 100	This defines when QoS stats records will be sent out of the Vega. When the QoS stats buffer reaches this number of records full, the Vega will send out all those records according to the current setting of Reporting Method
✓	✓	✓	✓	✓	method=off	IMM	off, terminal or transfer_method	This parameter defines whether and how QoS reports will be produced. (Currently only Off and Terminal are available.) Terminal means send records out to any/all telnet or serial interface sessions that are currently in progress
✓	✓	✓	✓	✓	type=gateway	IMM	calls, gateway or both	This defines whether the reports are to contain just gateway statistics, just call statistics or both
					[qos_profile.stats.syslog]			<b>See IN_15 QoS Statistics for details on use of these parameters</b>
✓	✓	✓	✓	✓	billing=0		0 or 1	Disable / enable billing records to be sent in Syslog QoS statistics
✓	✓	✓	✓	✓	codec=0		0 or 1	Disable / enable codec information to be sent in Syslog QoS statistics
✓	✓	✓	✓	✓	load_stats=0		0 or 1	Disable / enable system load information to be sent in Syslog QoS statistics
✓	✓	✓	✓	✓	network_events=0		0 or 1	Disable / enable network event information to be sent in Syslog QoS statistics
✓	✓	✓	✓	✓	network_stats=0		0 or 1	Disable / enable network statistics information to be sent in Syslog QoS statistics

FXS/ FXO	BRI	E/T1	H 3 2 3	S I P	Section/Parameter	Activate	Range	Comments
✓	✓	✓	✓	✓	profiles=0		0 or 1	Disable / enable QoS profile information to be sent in Syslog QoS statistics
✓	✓	✓	✓	✓	telephony_stats=0		0 or 1	Disable / enable telephony statistics information to be sent in Syslog QoS statistics
					[quick]			
✓	✓	✓		✓	country=UK	Quick Apply	UK, US, AR, AT, AU, BE, BR, CA, CL, ES, FR, IN, IT, MX, NL, RU, SE, None	Country to configure (for ring tone, FXO parameters etc)
✓	✓	✓		✓	emergency_numbers=999,112,911,000	Quick Apply	String	Comma separated list of emergency telephone numbers - these may optionally be routed in preference over the telephony interface rather than over IP
✓	✓	✓		✓	timezone_offset=0000	Quick Apply	HHMM	Timezone to apply when displaying or sending times 0000 = GMT
					[quick.bri]			
					line_type=pmp	Quick Apply	pmp, pp	Use point-to-multipoint or point-to-point for this BRI link
					[quick.bri.1]			
✓	✓			✓	handle_emergency_calls=0	Quick Apply		
✓	✓			✓	nt=0	Quick Apply		0 = TE, 1 = NT
✓	✓			✓	nt_phantom_power=0	Quick Apply		
✓	✓			✓	numlist=0301	Quick Apply		Comma separated list of TEL numbers to route to this port
✓	✓			✓	sameas=none	Quick Apply		
					[quick.codec]			
✓	✓	✓		✓	d1=t38udp	Quick Apply		First priority data codec
✓	✓	✓		✓	d2=g711Alaw64k	Quick Apply		Second priority data codec
✓	✓	✓		✓	d3=g711Ulaw64k	Quick Apply		Third priority data codec
✓	✓	✓		✓	d4=octet	Quick Apply		Fourth priority data codec
✓	✓	✓		✓	v1=g729	Quick Apply		First priority voice codec

FXS/FXO	BRI	E/T1	H 3 2 3	S I P	Section/Parameter	Activate	Range	Comments
✓	✓	✓		✓	v2=g711Ulaw64k	Quick Apply		Second priority voice codec
✓	✓	✓		✓	v3=g711Alaw64k	Quick Apply		Third priority voice codec
✓	✓	✓		✓	v4=g7231	Quick Apply		Fourth priority voice codec
					<b>[quick.e1t1.1]</b>			
		✓		✓	alloc_chan=default	Quick Apply		
		✓		✓	channels=auto	Quick Apply		
		✓		✓	handle_emergency_calls=0	Quick Apply		
		✓		✓	nt=0	Quick Apply		0 = TE, 1 = NT
		✓		✓	numlist=0401	Quick Apply		Comma separated list of TEL numbers to route to this port
		✓		✓	sameas=none	Quick Apply		
					<b>[quick.fxo.1]</b>			<b>fxo.1 = first FXO port on an FXS Vega fxo.2 = second FXO port on an FXS Vega</b>
✓				✓	handle_emergency_calls=0	Quick Apply		0 = do not send calls matching 'quick.emergency_numbers' out of this telecoms interface  1 = send calls matching 'quick.emergency_numbers' out of this telecoms interface
✓				✓	incoming_forward=default	Quick Apply		
✓				✓	name=FXO1	Quick Apply		Name of FXO port
✓				✓	numlist=0201	Quick Apply		Comma separated list of TEL numbers to route to this port
✓				✓	this_tel=0201	Quick Apply		TELC number to use for calls originating on this interface if caller ID is not provided.
					<b>[quick.fxs]</b>			
✓				✓	auth_source=Numeric_ID	Quick Apply		
					<b>[quick.fxs.1]</b>			<b>Configure FXS Ports</b>
✓				✓	auth_pwd=auth_password	Quick Apply		
✓				✓	auth_username=default	Quick		

FXS/EXO	BRI	E/T1	H323	SIP	Section/Parameter	Activate	Range	Comments
						Apply		
✓				✓	enable=1	Quick Apply		
✓				✓	name=FXS1	Quick Apply		
✓				✓	numlist=0101	Quick Apply		
✓				✓	this_tel=0101	Quick Apply		
					<b>[quick.lan]</b>			
✓	✓	✓		✓	dhcp=1	Quick Apply		
✓	✓	✓		✓	dns1=0.0.0.0	Quick Apply		IP address of DNS server
✓	✓	✓		✓	duplex=half	Quick Apply		
✓	✓	✓		✓	gateway=0.0.0.0	Quick Apply		IP address of default gateway
✓	✓	✓		✓	ip=0.0.0.0	Quick Apply		IP address of Vega
✓	✓	✓		✓	media priority=0	Quick Apply		
✓	✓	✓		✓	ntp=0.0.0.0	Quick Apply		IP address of NTP server
✓	✓	✓		✓	physpeed=Auto	Quick Apply		
✓	✓	✓		✓	subnet=255.255.255.0	Quick Apply		Subnet for local network
✓	✓	✓		✓	tos_diff=0	Quick Apply		
✓	✓	✓		✓	vlan_id=0	Quick Apply		
✓	✓	✓		✓	8021q=0	Quick Apply		
					<b>[quick.voip]</b>			
✓	✓	✓		✓	reg_type=off	Quick Apply		
✓	✓	✓		✓	useproxy=1	Quick Apply		
					<b>[quick.voip.endpoint.1]</b>			<b>First VoIP Endpoint Details</b>
✓	✓	✓		✓	ip=0.0.0.0	Quick Apply		IP address used for call routing
✓	✓	✓		✓	numlist=list of numbers	Quick Apply		List of numbers terminating on this VoIP endpoint.

FXS/EXO	BRI	E/T1	H323	SIP	Section/Parameter	Activate	Range	Comments
					[quick.voip.proxy]			
✓	✓	✓		✓	auth_name=Reg and Auth ID	Quick Apply		Authentication ID for "gateway registration"
✓	✓	✓		✓	auth_pwd=Reg and Auth Password	Quick Apply		Authentication password for "gateway registration"
✓	✓	✓		✓	outbound_proxy_addr=0.0.0.0	Quick Apply		IP address for first SIP hop
✓	✓	✓		✓	proxy_addr=default-proxy-1.com	Quick Apply		IP address for SIP proxy
✓	✓	✓		✓	proxy_domain_name=default-reg-domain.com	Quick Apply		SIP domain used for calls
✓	✓	✓		✓	registrar_addr=0.0.0.0	Quick Apply		IP address for SIP registrar
					[rs232.1]			
✓	✓	✓	✓	✓	baud_rate=115200	S/R	9600 / 19220 / 38400 / 57600 / 115200	Baud rate to use for specified console port
✓	✓	✓	✓	✓	data_bits=8	S/R	8	Data bits to use for specified console port
✓	✓	✓	✓	✓	flow_control=xonoff	S/R	none / xonxoff / hardware	Flow control type to use for specified console port
✓	✓	✓	✓	✓	parity=none	S/R	odd / even / mark / space / none	Parity bits to use for specified console port
✓	✓	✓	✓	✓	stop_bits=1	S/R	1 / 1.5 / 2	Stop bits to use for specified console port
					[serviceprofile]			
					[serviceprofile.1]			H.450 supplementary service section (up to 10 entries can be supported)
✓	✓		✓		name=default	CALL	length<32	Name of this service profile - for self documentation purposes
✓	✓		✓		transfer=1	CALL	0 or 1	0 = do not support call transfer, 1 = support call transfer
✓	✓		✓		Divert=1	CALL	0 or 1	0 = do not support call diversion, 1 = support call diversion
✓	✓		✓		transfer_caller_id=transferred_party	CALL	transferring_party transferred_party	When a transferred call is passed to the Vega, the Vega has a choice of two caller ids that it can pass on - the caller id of the transferring party or the caller id of the party being transferred.
					[sip]			
✓	✓	✓		✓	<a href="#">accept_non_proxy_invite_s=0</a>	APPLY	0 1	0 = Only allow SIP INVITES from the SIP Proxy (or backup proxies) 1 = Accept SIP INVITES from any SIP device
✓	✓	✓		✓	allow_sip_uri=1	APPLY	0, 1	0 = Only allow calls to proceed with a SIPS

FXS/EXO	BRI	E/T1	H 3 2 3	S I P	Section/Parameter	Activate	Range	Comments
								URI (secure SIP) 1 = Allow calls with either a SIPS or SIP URI
✓	✓	✓		✓	capset=2		1 .. 30	Codec capability set to use
✓	✓	✓		✓	default_uri_scheme=sip		sip or sips	Use SIP or SIPS URI scheme ... if sips is chosen, ensure that sip.sig_transport=tls (otherwise Vega will revert to sip mode)
✓	✓	✓		✓	<a href="#">dtmf_info</a> =model	APPLY	model or mode2	model: Vega format INFO messages for out of band DTMF  mode2: Cisco format INFO messages for out of band DTMF
✓	✓	✓		✓	<a href="#">dtmf_transport</a> =rfc2833	APPLY	rfc2833 info rfc2833_txinf o rfc2833_rxinf o	Use RFC2833 method for communicating out of band DTMF  Use INFO messages for communicating out of band DTMF  Transmit out of band DTMF both as RFC2833 messages and INFO messages (on receive, only action RFC2833 out of band DTMF messages)  Transmit out of band DTMF both as RFC2833 and action both RFC2833 and INFO DTMF messages - be careful using this mode, if both INFO and RFC2833 messages are received for a single tone, the Vega will action both the RFC2833 and the INFO request, and so double tones will be played.  N.B. Out Of Band DTMF must be configured for each relevant codec in order to transfer DTMF as info or RFC2833 messages.
✓	✓	✓		✓	enable_modem=1	APPLY	0 or 1	0 = treat fax and low speed modem calls as fax calls  1 = low speed modem calls use G.711 up- speeding unless V21 tone is heard, in which case call is handled as a fax call
✓	✓	✓		✓	fax_detect=terminating	APPLY	terminating, always, never	terminating: Vega only monitors for fax tones on calls made out of its telephony interface. (The dialled fax machine is the fax machine that will initiate the fax tones)  always: Vega monitors for fax tones on calls from both telephony and LAN interfaces  never: Vega does not monitor for fax tones
✓	✓	✓		✓	<a href="#">incoming_cause_mapping_index</a> =0	APPLY	Index	Cause code mapping entry to use from <a href="#">advanced.incoming_cause_mapping</a> to map incoming cause codes from this SIP interface
✓	✓	✓		✓	lan_profile=1		0 to 10	Lan profile to use for SIP calls
✓	✓	✓		✓	<a href="#">local_rx_port</a> =5060	APPLY	1 to 65535	IP Port number to receive SIP messages on
✓	✓	✓		✓	max_calls=120	S/R	E1: 1..120 T1: 1..96 Vega 50: 1..10 Vega 5000: 1..48	Maximum allowable calls in progress  (call clears with cause code 34 if max calls is exceeded)
✓	✓	✓		✓	media_control_profile=0		0..10	Define which media control profile (x) to use in media.control.x.dynamic_update

FXS/FXO	BRI	E/T1	H 3 2 3	S I P	Section/Parameter	Activate	Range	Comments
✓	✓	✓		✓	modem_detect=terminating	APPLY	terminating, always, never	terminating: Vega only monitors for modem tones on calls made out of its telephony interface. (The dialled modem is the modem that will initiate the modem tones)  always: Vega monitors for modem tones on calls from both telephony and LAN interfaces  never: Vega does not monitor for modem tones
✓	✓	✓		✓	<a href="#">outgoing_cause_mapping_index</a> =0	APPLY	Index	Cause code mapping entry to use from <a href="#">advanced.outgoing_cause_mapping</a> to map outgoing cause codes from this SIP interface
✓	✓	✓		✓	<a href="#">PRACK</a> =off	APPLY	off  supported  required	PROvisional ACKnowledge - not enabled  - Vega will respond if remote gateway asks for PRACK  - Vega will insist that the remote device uses PRACK
✓	✓	✓		✓	reg_enable=1	APPLY	0 or 1	Disable / enable SIP registration
✓	✓	✓		✓	reg_on_startup=1	S/R	0  1	Register on first call to that port  Register on power up or re-boot
✓	✓	✓		✓	<a href="#">rfc2833_payload</a> =101	APPLY	96 to 127	Alters the payload field in the RTP message that carries the rfc2833 data; valid values for rfc2833 data are 96 to 127. (A Vega receiving a call will always use the value provided by the calling party sdp). Some devices, like Cisco units need the rfc2833_payload to match at both ends - e.g. Cisco config > rtp payload-type nte 96 > dtmf-relay rtp-nte
✓	✓	✓		✓	sess_timer_index=1		1 to 3	Select session timer profile to use
✓	✓	✓		✓	<a href="#">sig_transport</a> =udp		udp, tcp, tls	Transport protocol for SIP messaging, UDP, TCP or TLS.
✓	✓	✓		✓	<a href="#">signalling_app_id</a> =none	APPLY	alpha numeric string 1..40 chars	Signalling Application ID - part of the SIP info message header
✓	✓	✓		✓	T38_annexe_accept=0		0 or 1	1: Vega will accept T38 Annex E requests in incoming SIP INVITE messages, allowing switching between voice and T.38 without a re-INVITE, RTP media can be changed on the fly
✓	✓	✓		✓	T38_annexe_use=0		0 or 1	1: Vega will offer T38 Annex E in outgoing SIP INVITE messages (offers both T.38 and a voice codec in the sdp offer allowing switching between voice and T.38 without a re-INVITE, RTP media can be changed on the fly)
✓	✓	✓		✓	T1=2000	APPLY	1 to 5000	T1 is the value of the first SIP timeout of a new message. For every SIP message retransmission the previous SIP timeout is doubled. (Up to 5 retries are attempted for PRACK and INVITE, and up to 10 retries for other methods). If no response is received after all the retries the Vega will send a CANCEL (with retries if it is not acknowledged).  In the case of an INVITE, if a 100 trying is received a new timer of value 64 * T1 is

FXS/EXO	BRI	E/T1	H323	SIP	Section/Parameter	Activate	Range	Comments
								started. If no 180 ringing (or other message >180) is received within this time then the Vega will send a CANCEL (with retries if it is not acknowledged).  Note also interactions with multiple proxies - see section 15.4.2.1 "Multiple SIP Proxy Support"
✓	✓	✓		✓	T2=4000	APPLY	1 to 40000	T2 limits the maximum SIP retry timeout; if T1*2^n > T2, then the timeout limits to T2.
					<a href="#">[sip.auth.user]</a>			
					<a href="#">[sip.auth.user.1]</a>			First of up to 20 authentication users
✓	✓	✓		✓	enable=1	APPLY	0 or 1	Enable this user authentication username / password combination
✓	✓	✓		✓	password=pass1	APPLY	Up to 31 characters	Password
✓	✓	✓		✓	resource_priority=routine		As specified in the currently active NameSpace list	Resource-Priority to specify for calls made to SIP by this user
✓	✓	✓		✓	sip_profile=1		1 .. 5	SIP profile to use for this authentication user
✓	✓	✓		✓	subscriber=IF:0101	APPLY	Up to 63 characters (IF: and TELC:)	This authentication is used on calls which are associated with this / these telephone interfaces / telephone numbers
✓	✓	✓		✓	username=authuser1	APPLY	Up to 31 characters	Username is used as the <body> of the authentication username; authentication username = <body>
					<a href="#">[sip.hold]</a>			
✓	✓	✓		✓	mode=silence		silence or sipping_service_11	silence = silence on hold sipping_service_11 = Music on hold using the draft-ietf-sipping-service-examples-11 method
					<a href="#">[sip.hold.music_service.1]</a>			1 <sup>st</sup> of only 1 music_service profile
✓	✓	✓		✓	ipname=0.0.0.0			IP address or DNS resolvable name of the music on hold server not DNS
✓	✓	✓		✓	port=5060			IP port number of the music on hold server
✓	✓	✓		✓	uri=NULL			URI to present to the music on hold server to get MoH, e.g.222@sip.VegaStream.com:5061
					<a href="#">[sip.profile.1]</a>			1 <sup>st</sup> of up to 5 SIP profiles
✓	✓	✓		✓	alt_domain=alt-reg-domain.com	APPLY	length<32 length<256	Alternate public domain to use in SIP INVITE headers  Select to use alt_domain rather than reg_domain, choose the appropriate value in _advanced.sip.from_header_host and _advanced.sip.to_header_host



FXS/FXO	BRI	E/T1	H323	SIP	Section/Parameter	Activate	Range	Comments
✓	✓	✓		✓	from_header_host=reg_domain	APPLY	ipname/ reg_domain/ alt_domain	outgoing INVITE uses ipname / sip.reg_domain / alt_domain in SIP From: header
✓	✓	✓		✓	from_header_userinfo=calling_party		calling_party or auth_username	calling_party: in an outgoing INVITE calling party number is used in the From: header before the @  auth_username: in an outgoing INVITE authentication username is used in the From: header before the @
✓	✓	✓		✓	interface=9901	S/R	length<32	Interface ID of SIP interface
✓	✓	✓		✓	name=profile1	APPLY	length<32	Name of this SIP profile - for self documentation purposes
✓	✓	✓		✓	<a href="#">reg_domain</a> =default-reg-domain.com	APPLY	length<32 length<256	Public domain to use in SIP INVITE headers  To use reg_domain rather than alt_domain, choose the appropriate value in _advanced.sip.from_header_host and _advanced.sip.to_header_host
✓	✓	✓		✓	reg_expiry=600	APPLY	1 to 10000	Lifetime of registration (ms) (before re-registration attempted). Minimum time Vega actions is 10 seconds
✓	✓	✓		✓	reg_req_uri_port=5060		0 to 65535	1..65535: port number to be used in the request URI of Registration requests. This is separately configurable from the reg_remote_rx_port (the port that the Registration messages are sent to) so that in cases where an outbound proxy is being used, the destination port in the URI can be different from the port of the outbound proxy 0: no port will appear in the request URI
✓	✓	✓		✓	req_uri_port=5060		0 to 65535	1..65535: port number to be used in the request URI of Vega initiated SIP calls. This is separately configurable from the remote_rx_port (the port that the SIP messages are sent to) so that in cases where an outbound proxy is being used, the destination port in the URI can be different from the port of the outbound proxy 0: no port will appear in the request URI
✓	✓	✓		✓	sig_transport=udp	S/R	udp / tcp / tls	Signalling transport to use for SIP messages, UDP, TCP or TLS.
✓	✓	✓		✓	to_header_host=reg_domain	APPLY	ipname/ reg_domain/ alt_domain	outgoing INVITE uses ipname / sip.reg_domain / alt_domain in SIP To: header and in SIP URI
					[sip.profile.1.proxy]			
✓	✓	✓		✓	accessibility_check=off	APPLY	off or options	off: Only treat proxy as failed if SIP timeouts fail the call - then use alternate proxy for that call  options: Treat proxy as failed if SIP OPTIONS messages are not responded to by the proxy (use alternate proxy for all calls until OPTIONS messages are responded to again)
✓	✓	✓		✓	accessibility_check_transport=udp	S/R	udp / tcp / tls	Signalling transport to use for transmitting configured SIP availability check messages, UDP, TCP or TLS.

FXS/EXO	BRI	E/T1	H 3 2 3	S I P	Section/Parameter	Activate	Range	Comments
✓	✓	✓		✓	min_valid_response=180	APPLY	0 to 1000	Once the Vega receives a response of the minimum value specified by this parameter (or greater), it knows that the proxy is "up" and the Vega will not try another proxy in the list
✓	✓	✓		✓	mode=normal	APPLY	normal  cyclic  dnssrv	normal = try other proxies only when first proxy in the list is not available, and then try proxy 2, proxy 3 etc. in order  cyclic = for each call try the next SIP proxy in sequence, proxy 1, proxy 2, proxy 3 etc.... then back to proxy 1.  dnssrv = use dns access on the 1 <sup>st</sup> proxy entry (only), pick up the dnssrv record (IP address, port and weighting) and use the weighting to select the proxy
✓	✓	✓		✓	retry_delay=0		0 .. 1000	When a proxy is deemed to have failed and the Vega switches to using an alternate proxy, this timer specifies how long to wait before trying that failed proxy again (allowing the proxy time to recover and minimising the delay on future phone calls ... they do not have to time out before being routed using a backup proxy)  0 = try master proxy first for every call even if it was failed for last call that was presented.
✓	✓	✓		✓	timeout_ms=5000	APPLY	0 to 100000	If the Vega does not receive a "minimum valid response" to an INVITE within the time specified by this parameter, then the Vega will try the next proxy in the list.
					[sip.profile.1.proxy.1]			First sip proxy (of a maximum of 10) - superceeds sip.default_proxy, sip.remote_rx_proxy and all sip.backup_proxy.n
✓	✓	✓		✓	enable=1	APPLY	0 or 1	0 = don't send INVITES to this proxy, but if a call arrives from this proxy accept it.  1 = allow sending of INVITES to this proxy
✓	✓	✓		✓	ipname=default-proxy-1.com	APPLY	Up to 32 characters	The IP address or resolvable DNS name of the proxy
✓	✓	✓		✓	port=5060	APPLY	1 to 65535	IP port to use to access this proxy (not used when mode = dnssrv as dnssrv supplies IP port)
✓	✓	✓		✓	tls_port=5061		1 to 65535	Port to send TLS traffic to
					[sip.profile.1.registrar]			
✓	✓	✓		✓	accessibility_check=off	APPLY	off or options	off: Only treat registrar as failed if SIP timeouts fail the registration - then use alternate registrar for that registration  options: Treat registrar as failed if SIP OPTIONS messages are not responded to by the registrar (use alternate registrar for all registratins until OPTIONS messages are responded to again)
✓	✓	✓		✓	accessibility_check_transpor	S/R	udp / tcp /	Signalling transport to use for transmitting configured SIP availability check messages,

FXS/EXO	BRI	E/T1	H 3 2 3	S I P	Section/Parameter	Activate	Range	Comments
					t=udp		tls	UDP, TCP or TLS.
✓	✓	✓		✓	max_registrars=3			Maximum number of Registrars that the Vega will search [in this profile] in order to find a Registrar that will respond with a 'success' response.
✓	✓	✓		✓	min_valid_response=200	APPLY	0 to 1000	Minimum SIP response value that indicates a successful response from the Registrar
✓	✓	✓		✓	mode=normal	APPLY	normal  dnssrv	normal = try next registrar only when previous registrar does not provide a 'success' response.  dnssrv = use dns access on the 1 <sup>st</sup> registrar entry (only), pick up the dnssrv record (IP address, port and weighting) and use the weighting to select the registrar
✓	✓	✓		✓	retry_delay=0		0 .. 1000	When a registrar is deemed to have failed and the Vega switches to using an alternate registrar, this timer specifies how long to wait before trying that failed registrar again (allowing it time to recover).  0 = try master proxy first for every call even if it was failed for last call that was presented.
✓	✓	✓		✓	timeout_ms=5000			Timeout in milliseconds to wait for a response from each Registrar
					<b>[sip.profile.1.registrar.1]</b>			
✓	✓	✓		✓	enable=0	APPLY	0 or 1	1 = enable this registrar to be used [in this profile] by the Vega
✓	✓	✓		✓	ipname=default-registrar-1.com	APPLY	Up to 32 characters	The IP address or resolvable DNS name of the registrar
✓	✓	✓		✓	port=5060	APPLY	1 to 65535	IP port to use to access this registrar (not used when mode = dnssrv as dnssrv supplies IP port)
✓	✓	✓		✓	tls_port=5061		1 to 65535	Port to send TLS registrations to
					<b>[sip.reg.user.1]</b>			Sip registration parameters - first of up to 16 entries
✓	✓	✓		✓	auth_user_index=1	APPLY	1 to 100	Authentication parameters to use if SIP authentication is demanded (see sip.auth.user.n)
✓	✓	✓		✓	dn=100		Up to 31 characters	Dn specifies the nn in the SIP registration contact address <a href="#">nn@ip_address_of_vega</a>
✓	✓	✓		✓	enable=0	APPLY	0 or 1	Enable these registration details
✓	✓	✓		✓	sip_profile=1		1 .. 5	SIP profile to use for this registration user
✓	✓	✓		✓	username=01	APPLY	Up to 31 characters	Username is used as the <body> of the registration username; registration username = <body>
					<b>[sip.remote_admin]</b>			Remote admin (authentication) details
✓	✓	✓		✓	realm=default_realm		Up to 63 characters	Realm for Vega initiated authentication

FXS/FXO	BRI	E/T1	H323	SIP	Section/Parameter	Activate	Range	Comments
					[sip.remote_admin.1]			Remote admin user (authentication) details - first of up to 3 entries
✓	✓	✓		✓	enable=0		0 or 1	Enable this authentication user
✓	✓	✓		✓	password=default		Up to 63 characters	Password for Vega initiated authentication (note authentication will always fail if this is not changed from the value 'default')
✓	✓	✓		✓	Username=default		Up to 63 characters	Username for Vega initiated authentication (note authentication will always fail if this is not changed from the value 'default')
					[sip.sess_timer.1]			First of up to 3 session timer profiles; Active session timer profile defined by sip.session_timer_index See RFC 4028 for full details on Session Timers
✓	✓	✓		✓	enable=0		0 or 1	1 = enable this session timer
✓	✓	✓		✓	interval=1800		120 .. 7200	Preferred time interval Vega will negotiate with far end for checking continued connection of the call (in seconds)- uses a re-INVITE, and checks that it receives a response.
✓	✓	✓		✓	min_interval=300		120 .. 7200	Minimum time interval Vega will negotiate with far end for checking continued connection of the call (in seconds).
✓	✓	✓		✓	refresher_pref=remote		local or remote	local: this Vega will initiate Session Timer re-invites remote: destination device is requested to initiate Session Timer re-invites
					[sip.srtp]			
✓	✓	✓		✓	mode=off		off, supported, require, require_rfc4568	off: SRTP not used (initiated or accepted) supported: uses "RTP/AVP" in "m=" line and adds the "a=crypto:" line. It interops with non-SRTP UAs (i.e. only best-effort to use SRTP) require: uses "RTP/AVP" in "m=" line and adds the "a=crypto:" line Requires that remote endpoint has the "a=crypto:" line require_rfc4568: as 'require' but uses "RTP/SAVP" in "m=" line
✓	✓	✓		✓	auth_bits_default=80		32 or 80	32: Request 32 bit authentication in any initiated INVITE 80: Request 80 bit authentication in any initiated INVITE
✓	✓	✓		✓	auth_bits_min=32		32 or 80	32: Min authentication level accepted (where encryption is used) is 32 bit authentication 80: Min authentication level accepted (where encryption is used) is 80 bit authentication
					[sip.tls]			
✓	✓	✓		✓	local_rx_port=5061		1 to 65535	Listening port for tls traffic

FXS/EXO	BRI	E/T1	H 3 2 3	S I P	Section/Parameter	Activate	Range	Comments
					[sipproxy]			See also 'IN_41-Vega Resilience Proxy' on <a href="http://www.VegaAssist.com">www.VegaAssist.com</a>
✓	✓	✓		✓	mode=off		standalone_proxy , forward_to_itsp , itsp_trunk or off	standalone_proxy: No forwarding of SIP messages to the ITSP occurs - all registrations and routing are handled by the resilience proxy  forward to ITSP: Normal ITSP resilience mode  itsp_trunk: Calls to registered devices are sent directly to the endpoints, calls to non-registered destinations are forwarded to the ITSP  off: Resilience proxy is disabled
✓	✓	✓		✓	realm=abcdefghijklwhatever.com		1 to 127 characters	Realm (domain) of ITSP proxy
✓	✓	✓		✓	rx_port=5062			IP Port on which Resilience proxy listens for requests
					[sipproxy.auth.user]			
✓	✓	✓		✓	use_aliases=if_itsp_down		always, if_itsp_down, never	always: always check for aliases if_itsp_down: check for aliases when in ITSP Down mode never: never handle aliases
					[sipproxy.auth.user.1]			(Entries are not needed here if allowed device is in a trusted IP address range)
✓	✓	✓		✓	aliases=NULL	APPLY	NULL or up to three comma separated aliases, each up to 80 chars	NULL: no alias defined  Aliases: can contain up to 3 comma separated aliases. Each alias can be up to 80 characters, and each can include regular expressions.
✓	✓	✓		✓	enable=0	APPLY	0 or 1	Enable this set of authentication entries
✓	✓	✓		✓	username=user	APPLY	1 to 63 characters	Authentication user name (same as registration user name)
✓	✓	✓		✓	password=pass	APPLY	1 to 63 characters	Authentication password to register with Resilience Proxy
					[sipproxy.fallback_pstn_gateway]			
✓	✓	✓		✓	gw_list=all	APPLY	1 to 31 characters	Comma separated list of trunk gateways that can be used in the event that PSTN fallback is required
✓	✓	✓		✓	redirection_responses=500-599	APPLY	1 to 63 characters	Range of SIP responses that result in trying the next gateway in the list. If a SIP response outside this range is received the call will be dropped.
✓	✓	✓		✓	routing_rule=linear_up	APPLY	1 to 31 characters	Specifies how the gateways in the list will be tried.
					[sipproxy.ignore.1]			
✓	✓	✓		✓	enable=0		0 or 1	Enable this 'ignore' entry

FXS/EXO	BRI	E/T1	H 3 2 3	S I P	Section/Parameter	Activate	Range	Comments
✓	✓	✓		✓	ipmax=0.0.0.0		IP address or DNS hostname	Upper range of IP address values to ignore SIP messaging from (provide no response)
✓	✓	✓		✓	ipmin=0.0.0.0		IP address or DNS hostname	Lower range of IP address values to ignore SIP messaging from (provide no response)
					[sipproxy.itsp_nat]			
✓	✓	✓		✓	rport=0		0 or 1	If set to 1, Vega will insert the rport parameter into the Via header of SIP messages.
					[sipproxy.itsp_proxy]			
✓	✓	✓		✓	accessibility_check=options	APPLY	off or options	off: Only treat ITSP Proxy as failed if SIP timeouts fail the call - then use alternate resilience proxy functionality for that call [this setting is NOT RECOMMENDED]  options: Treat ITSP proxy as failed if SIP OPTIONS messages are not responded to by the ITSP proxy (use resilience proxy for all calls until OPTIONS messages are responded to again)
✓	✓	✓		✓	accessibility_check_transport=udp	S/R	udp / tcp	Signalling transport to use for transmitting configured SIP availability check messages, UDP or TCP.
✓	✓	✓		✓	mode=normal	normal, cyclic, dnssrv		Normal: sipproxy.itsp_proxy.1 is used, unless it is not available, then .2, then .3 etc.  Cyclic: basic load sharing; .1 is used for first call, .2 for second, .3 for 3 <sup>rd</sup> looping to use the next enabled proxy for each subsequent call.  Dnssrv: use the dnssrv entry of sipproxy.itsp_proxy.1.ipname to define the proxies to send calls to and their relevant weightings.
✓	✓	✓		✓	redirection_responses=500-599			
✓	✓	✓		✓	sig_transport=udp	S/R	udp / tcp	Signalling transport to use for transmitting SIP messages to this proxy, UDP or TCP.
					[sipproxy.itsp_proxy.1]			
✓	✓	✓		✓	enable=0		0 or 1	Enable this ITSP's proxy details
✓	✓	✓		✓	ipname=0.0.0.0		IP address or DNS hostname	IP address or DNS hostname of the proxy
✓	✓	✓		✓	port=5060		0 .. 32767	IP port number of the ITSP's proxy
					[sipproxy.reject.1]			
✓	✓	✓		✓	enable=0		0 or 1	Enable this 'reject' entry
✓	✓	✓		✓	ipmax=0.0.0.0		IP address or DNS hostname	Upper range of IP address values to actively reject SIP messaging from
✓	✓	✓		✓	ipmin=0.0.0.0		IP address or DNS hostname	Lower range of IP address values to actively reject SIP messaging from

FXS/FXO	BRI	E/T1	H323	SIP	Section/Parameter	Activate	Range	Comments
					[sipproxy.trunk_gw]			
✓	✓	✓		✓	accessibility_check=options	APPLY	off or options	off: Only treat ITSP Proxy as failed if SIP timeouts fail the call - then use alternate resilience proxy functionality for that call [this setting is NOT RECOMMENDED]  options: Treat ITSP proxy as failed if SIP OPTIONS messages are not responded to by the ITSP proxy (use resilience proxy for all calls until OPTIONS messages are responded to again)
✓	✓	✓		✓	accessibility_check_transport=udp	S/R	udp / tcp	Signalling transport to use for transmitting configured SIP availability check messages, UDP or TCP.
✓	✓	✓		✓	allow_itsp_calls_to_pstn=never			
✓	✓	✓		✓	from_action=trust			
✓	✓	✓		✓	mode=normal			
✓	✓	✓		✓	sig_transport=udp	S/R	udp / tcp	Signalling transport to use for transmitting SIP messages to this trunk gateway, UDP or TCP.
					[sipproxy.trunk_gw.forward_to_itsp_mode]			
✓	✓	✓		✓	allow_local_trunk_calls_to_itsp=never			
✓	✓	✓		✓	allow_pstn_calls_to_itsp=never			
					[sipproxy.trunk_gw.plan.1]			
✓	✓	✓		✓	dest=TEL:911			
✓	✓	✓		✓	enable=0			
✓	✓	✓		✓	gw_list=1			
✓	✓	✓		✓	name=emergency			
✓	✓	✓		✓	redirection_responses=500-599			
✓	✓	✓		✓	routing_rule=linear_up			
					[sipproxy.trunk_gw.1]			
✓	✓	✓		✓	enable=1			
✓	✓	✓		✓	ipname=trunk_gateway_at_127.0.0.1			
✓	✓	✓		✓	is_pstn_gw=0			
✓	✓	✓		✓	port=0			
					[sipproxy.trust]			
✓	✓	✓		✓	disable_all=0			

FXS/EXO	BRI	E/T1	H323	SIP	Section/Parameter	Activate	Range	Comments
					[sipproxy.trust.1]			
✓	✓	✓		✓	enable=0		0 or 1	Enable this 'trust' entry
✓	✓	✓		✓	ipmax=user		IP address or DNS hostname	Upper range of IP address values to trust SIP messaging from (don't demand authentication)
✓	✓	✓		✓	ipmin=pass		IP address or DNS hostname	Lower range of IP address values to trust SIP messaging from (don't demand authentication)
					[smtp]			
✓	✓	✓	✓	✓	domain=abcdefghijklwhatever.com			
✓	✓	✓	✓	✓	ip=0.0.0.0			
✓	✓	✓	✓	✓	lan_profile=1			
✓	✓	✓	✓	✓	port=25			
					[snmp]			
✓	✓	✓		✓	lan_profile=1		0 .. 10	Lan profile to use for SNMP
					[snmp.mib2.communities.1]			
✓	✓	✓	✓	✓	name=public			Community name (referenced by snmp.mib2.managers.x.community)
✓	✓	✓	✓	✓	get=1			1 = allow members of this community to read MIBs
✓	✓	✓	✓	✓	set=1			1 = allow members of this community to set values via SNMP
✓	✓	✓	✓	✓	traps=1			1 = enable traps to be sent to members of this community
					[snmp.mib2.managers.1]			List of who is allowed to manage this Vega
✓	✓	✓	✓	✓	community=public			Manager's community (one of the snmp.mib2.communities.x.name)
✓	✓	✓	✓	✓	ip=0.0.0.0			Manager's IP address
✓	✓	✓	✓	✓	subnet=255.255.255.0			Mask to identify significant part of manager's ip address to check
✓	✓	✓	✓	✓	support_snmpv3=1			0 = enable SNMP V1 support 1 = enable SNMP V3 support
					[snmp.mib2.system]			
✓	✓	✓	✓	✓	SysContact=abcdefghijklwhatever.com			Contact name for this device (to populate MIB)
✓	✓	✓	✓	✓	sysLocation=PlanetEarth			Location of this device (to populate MIB)
					[ssh]			
✓	✓	✓	✓	✓	port=22	P,IMM	1 to 65535	IP port number for SSH



FXS/EXO	BRI	E/T1	H323	SIP	Section/Parameter	Activate	Range	Comments
					[suppserv]			
✓				✓	enable=0	IMM		Enable supplementary services (on FXS ports)
					[suppserv.profile.1]			See also "IN_27 FXS Call transfer"
✓				✓	call_conference_mode=cmd_mode			
✓				✓	call_waiting=cmd_mode			
✓				✓	call_waiting_hangup=hangup_all			
✓				✓	code_blind_xfer=*98*			If these DTMF tones are heard after a 'recall' then initiate a blind transfer
✓				✓	code_call_clear=*52			If these DTMF tones are heard when in command mode of a call hold / transfer, clear the caller you were last connected to
✓				✓	code_call_conference=*54			If these DTMF tones are heard after a 'recall' then initiate a blind transfer
✓				✓	code_call_cycle=!			Signal to Vega to switch between calls on hold and command mode.
✓				✓	code_cfb_off=*91			DTMF string to use to disable call forward busy.
✓				✓	code_cfb_on=*90			DTMF string to use to enable call forward busy
✓				✓	code_cfna_off=*93			DTMF string to use to disable call forward no answer
✓				✓	code_cfna_on=*92			DTMF string to use to enable call forward no answer
✓				✓	code_cfu_off=*73			DTMF string to use to disable call forward unconditional
✓				✓	code_cfu_on=*72			DTMF string to use to enable call forward unconditional
✓				✓	code_consult_xfer=*99			By pressing these keys when in command mode, having got 2 parties on hold, the Vega will connect the two parties, and drop the initiator out of the call. (Often easier just to clear down to cause the other two parties to be connected, but xfer_on_hangup must = 1)
✓				✓	code_disable_all=*00			
✓				✓	code_dnd_off=*79			Time to wait after telephone number / extension number digits are dialled to ensure that whole number is complete.
✓				✓	code_dnd_on=*78			
✓				✓	recall=!			Signal used to indicate the recall event: ! = hookflash (time-break)
✓				✓	xfer_on_hangup=1			0 = kill all legs of the call if the person initiating the call transfer clears their leg of the call  1 = Complete the call transfer if the person initiating the call transfer clears their leg of the call.

FXS/EXO	BRI	E/T1	H 3 2 3	S I P	Section/Parameter	Activate	Range	Comments
					[system]			
✓	✓	✓	✓	✓	local_offset=0000	APPLY	0 to +/-2359	HHMM or -HHMM ... base time offset from UTC
✓	✓	✓	✓	✓	dst_offset=0100	APPLY	0 to +/-0600	HHMM or -HHMM ... time offset to apply from local time when changing to DST
					[system.dst_begin]			
✓	✓	✓	✓	✓	day=Sun	APPLY	1st, 2nd, 3rd, 4th, Last  concatenated with  Mon, Tue, Wed, Thu, Fri, Sat, Sun	day that DST starts, e.g. LastSun, or SecondThu
✓	✓	✓	✓	✓	day_instance=last			
✓	✓	✓	✓	✓	localtime=1			DO NOT CHANGE - ensure that this is set to 1
✓	✓	✓	✓	✓	mon=Mar	APPLY	Jan, Feb, Mar, Apr, May, Jun, Jul, Aug. Sep, Oct, Nov, Dec	month of change
✓	✓	✓	✓	✓	time=0100	APPLY	0000 to 2359	time of change (specified in base time)
✓	✓	✓	✓	✓				
✓	✓	✓	✓	✓	[system.dst_end]			
✓	✓	✓	✓	✓	day=LastSun	APPLY	1st, 2nd, 3rd, 4th, Last  concatenated with  Mon, Tue, Wed, Thu, Fri, Sat, Sun	day that DST ends, e.g. LastSun, or 2ndThu
✓	✓	✓	✓	✓	day_instance=last			
✓	✓	✓	✓	✓	localtime=1			DO NOT CHANGE - ensure that this is set to 1
✓	✓	✓	✓	✓	mon=Oct	APPLY	Jan, Feb, Mar, Apr, May, Jun, Jul, Aug. Sep, Oct, Nov, Dec	month of change
✓	✓	✓	✓	✓	time=0200	APPLY	0000 to 2359	time of change (specified in DST time)
					[telnet]			Telnet parameters
✓	✓	✓	✓	✓	enable=1		0 .. 1	Enable telnet access
✓	✓	✓	✓	✓	lan_profile=1		0 to 10	Lan profile to use for telnet accesses
✓	✓	✓	✓	✓	port=23		1 to 65535	Port number on which Vega will accept telnet traffic

FXS/EXO	BRI	E/T1	H 3 2 3	S I P	Section/Parameter	Activate	Range	Comments
					[tftp]			TFTP parameters
✓	✓	✓	✓	✓	dhcp_if=1		0 or 1 or 2	1..2 - Lan interface to get DHCP IP address from - if DHCP for tftp is enabled in that interface  0 - do not use DHCP to get tftp IP
✓	✓	✓	✓	✓	<a href="#">ip=0.0.0.0</a>	P, APPLY	IP address/ host name	TFTP server IP address (0.0.0.0 for none)
✓	✓	✓	✓	✓	lan_profile=1		0 to 10	Lan profile to use for tftp accesses
✓	✓	✓	✓	✓	ping_test=0	P,IMM	0 or 1	Before a tftp transfer is performed a ping is sent to the far end. The sending of the ping can be disabled by setting this parameter to 0.
✓	✓	✓	✓	✓	port=69	P,IMM	1 to 65535	IP port number for TFTP
✓	✓	✓	✓	✓	timeout=4	P,IMM	1 to 60	TFTP timeout
					[tonedetect.busy.1]			
✓			✓	✓	enable=1	S/R	0, 1	Enable this tone detect profile
✓			✓	✓	freq1=400	S/R		First defined frequency
✓			✓	✓	freq2=0	S/R		Second defined frequency (use for multi tone frequencies)
✓			✓	✓	freq3=0	S/R		Third defined frequency (use for multi tone frequencies)
✓			✓	✓	offtime1=375	S/R		Off time between first and second tone
✓			✓	✓	offtime2=0	S/R		Off time between second and thirddtone
✓			✓	✓	offtime3=0	S/R		Off time after third tone
✓			✓	✓	ontime1=375	S/R		On time for first tone
✓			✓	✓	ontime2=0	S/R		On time for second tone
✓			✓	✓	ontime3=0	S/R		On time for third tone
					[tonedetect.congestion.1]			
✓			✓	✓	enable=1	S/R	0, 1	Enable this tone detect profile
✓			✓	✓	freq1=400	S/R		First defined frequency
✓			✓	✓	freq2=0	S/R		Second defined frequency (use for multi tone frequencies)
✓			✓	✓	freq3=0	S/R		Third defined frequency (use for multi tone frequencies)
✓			✓	✓	offtime1=375	S/R		Off time between first and second tone
✓			✓	✓	offtime2=0	S/R		Off time between second and thirddtone
✓			✓	✓	offtime3=0	S/R		Off time after third tone
✓			✓	✓	ontime1=375	S/R		On time for first tone
✓			✓	✓	ontime2=0	S/R		On time for second tone
✓			✓	✓	ontime3=0	S/R		On time for third tone

FXS/EXO	BRI	E/T1	H323	SIP	Section/Parameter	Activate	Range	Comments
					<b>[tonedetect.disconnect.1]</b>			
✓			✓	✓	enable=1	S/R	0, 1	Enable this tone detect profile
✓			✓	✓	freq1=400	S/R		First defined frequency
✓			✓	✓	freq2=0	S/R		Second defined frequency (use for multi tone frequencies)
✓			✓	✓	freq3=0	S/R		Third defined frequency (use for multi tone frequencies)
✓			✓	✓	offtime1=375	S/R		Off time between first and second tone
✓			✓	✓	offtime2=0	S/R		Off time between second and thirdtone
✓			✓	✓	offtime3=0	S/R		Off time after third tone
✓			✓	✓	ontime1=375	S/R		On time for first tone
✓			✓	✓	ontime2=0	S/R		On time for second tone
✓			✓	✓	ontime3=0	S/R		On time for third tone
					<b>[tones]</b>			<b>Tones Definition Section</b>
✓	✓	✓	✓	✓	busytone_seq=3	APPLY	index	Index number of busy tone sequence in the tone sequence table (y in tones.seq.y)
✓	✓	✓	✓	✓	callwait1_seq=6	APPLY	index	Index number of call waiting tone sequence 1 in the tone sequence table (y in tones.seq.y)
✓	✓	✓	✓	✓	callwait2_seq=7	APPLY	index	Index number of call waiting tone sequence 2 in the tone sequence table (y in tones.seq.y)
✓	✓	✓	✓	✓	dialtone_seq=1	APPLY	index	Index number of dial tone sequence in the tone sequence table (y in tones.seq.y)
✓	✓	✓	✓	✓	fastbusy_seq=4	APPLY	index	Index number of fast busy tone sequence in the tone sequence table (y in tones.seq.y)
✓	✓	✓		✓	forwarding_seq=51	APPLY	index	Index number of forwarding tone sequence in the tone sequence table (y in tones.seq.y)
✓	✓	✓	✓	✓	ringback_seq=5	APPLY	index	Index number of ringback tone sequence in the tone sequence table (y in tones.seq.y)
✓	✓	✓	✓	✓	stutterd_seq=2	APPLY	index	Index number of stuttered dial tone sequence in the tone sequence table (y in tones.seq.y)
✓	✓	✓		✓	suspended_seq=8	APPLY	index	Index number of suspended tone sequence in the tone sequence table (y in tones.seq.y)
					<b>[tones.def.1]</b>			Tone definition entry table
✓	✓	✓	✓	✓	name=UK_dialtone	APPLY	length<32	Name of this tone definition - for self documentation purposes
✓	✓	✓	✓	✓	amp1=6000	APPLY	0-32500	amplitude of frequency 1
✓	✓	✓	✓	✓	amp2=6000	APPLY	0-32500	amplitude of frequency 2
✓	✓	✓	✓	✓	amp3=0	APPLY	0-32500	amplitude of frequency 3
✓	✓	✓	✓	✓	amp4=0	APPLY	0-32500	amplitude of frequency 4
✓	✓	✓	✓	✓	freq1=350	APPLY	0-4000	frequency 1
✓	✓	✓	✓	✓	freq2=440	APPLY	0-4000	frequency 2
✓	✓	✓	✓	✓	freq3=0	APPLY	0-4000	frequency 3
✓	✓	✓	✓	✓	freq4=0	APPLY	0-4000	frequency 4

FXS/EXO	BRI	E/T1	H 3 2 3	S I P	Section/Parameter	Activate	Range	Comments
✓	✓	✓	✓	✓	off_time=0	APPLY	0-10000	Duration of silence following on time tone
✓	✓	✓	✓	✓	on_time=0	APPLY	0-10000	0 = Play tone forever 1-10000 = Duration tone is on for (ms)
✓	✓	✓	✓	✓	repeat=1	APPLY	0 or 1	0 = just play tone on / off 1 = repeat cycling tone on / off
					<a href="#">[tones.net]</a>			
✓	✓	✓		✓	ring=1	APPLY	0 or 1	set to '1' enables the playing of ringback tone towards the packet network when an Alerting is received, provided that no media is indicated. This parameter operates on Progress messages as well as Alerting messages
					<a href="#">[tones.seq.1]</a>			Tones sequencing table
✓	✓	✓	✓	✓	name=UK_dial_seq	APPLY	length<32	Name of this tone sequence - for self documentation purposes
✓	✓	✓	✓	✓	repeat=0	APPLY	0 or 1	0 = just play sequence through once 1 = repeat cycling through specified sequence of tones
					<a href="#">[tones.seq.1.tone.1]</a>			First entry in tone sequence play list
✓	✓	✓	✓	✓	duration=600000	APPLY	0-7200000	Duration to play this tone
✓	✓	✓	✓	✓	play_tone=1	APPLY	index	Index number of tone definition to play (x in tones.def.x)
					<a href="#">[users]</a>			User account section
✓	✓	✓	✓	✓	radius_login=0	S/R	0,1	When enabled the Vega will send the login credentials to the configured radius server. If disabled the local copy of the login credentials is used.
					<a href="#">[users.admin]</a>	LOG		Administrator user section
✓	✓	✓	✓	✓	billing=0	LOG	0-2	0=No billing at login 1=Set 'bill on' and 'bill display on' at login 2=Set 'bill z' and 'bill display on' at login
✓	✓	✓	✓	✓	logging=3	LOG	0-6	0=no logging, 1=all messages logged, 2=Alert and above messages logged, 3=Warning and above messages logged, 4=Failure and above messages logged, 5=Error and above messages logged, 6=X_fatal messages logged ... from next login
✓	✓	✓	✓	✓	prompt=%u%p>	LOG	length<32	Admin user prompt: %n = host name %i = host IP address (Lan 1) %t = local time %p = configuration path %u = user name
✓	✓	✓	✓	✓	remote_access=1	LOG	0 or 1	Disable / enable remote access (Telnet and www)

FXS/EXO	BRI	E/T1	H 3 2 3	S I P	Section/Parameter	Activate	Range	Comments
✓	✓	✓	✓	✓	timeout=1800	LOG	0 to 7200	1 to 7200 = timeout in seconds 0 = no timeout - but this can cause <a href="#">adverse effects with the web browser</a>
					<a href="#">[users.billing]</a>			Billing user section (no www access)
✓	✓	✓	✓	✓	billing=1	LOG	0-2	0=No billing at login 1=Set 'bill on' and 'bill display on' at login 2=Set 'bill z' and 'bill display on' at login
✓	✓	✓	✓	✓	logging=0	LOG	0-6	0=no logging, 1=all messages logged, 2=Alert and above messages logged, 3=Warning and above messages logged, 4=Failure and above messages logged, 5=Error and above messages logged, 6=X_fatal messages logged ... from next login
✓	✓	✓	✓	✓	prompt=%u%p>	LOG	length<32	Billing user prompt: %n = host name %i = host IP address (Lan 1) %t = local time %p = configuration path %u = user name
✓	✓	✓	✓	✓	remote_access=1	LOG	0 or 1	Disable / enable remote access (Telnet)
✓	✓	✓	✓	✓	timeout=0	LOG	0-7200	1 to 7200 = timeout in seconds 0 = no timeout
					<a href="#">[users.user]</a>			Ordinary user section (no www access)
✓	✓	✓	✓	✓	billing=0	LOG	0-2	0=No billing at login 1=Set 'bill on' and 'bill display on' at login 2=Set 'bill z' and 'bill display on' at login
✓	✓	✓	✓	✓	logging=3	LOG	0-6	0= no logging, 1=all messages logged, 2=Alert and above messages logged, 3=Warning and above messages logged, 4=Failure and above messages logged, 5=Error and above messages logged, 6=X_fatal messages logged ... from next login
✓	✓	✓	✓	✓	prompt=%u%p>	LOG	length<32	User user prompt: %n = host name %i = host IP address(Lan 1) %t = local time %p = configuration path %u = user name
✓	✓	✓	✓	✓	remote_access=1	LOG	0 or 1	Disable / enable remote access (Telnet)
✓	✓	✓	✓	✓	timeout=0	LOG	0-7200	1 to 7200 = timeout in seconds 0 = no timeout
					<a href="#">[users.1]</a>			User defined users
✓	✓	✓	✓	✓	password=user1			Password for this user
✓	✓	✓	✓	✓	privileges=none			Privilege level
✓	✓	✓	✓	✓	timeout=1800	LOG	0-7200	1 to 7200 = timeout in seconds 0 = no timeout
✓	✓	✓	✓	✓	username			Username for this user

FXS/FXO	BRI	E/T1	H 3 2 3	S I P	Section/Parameter	Activate	Range	Comments
					<a href="#">[voice_prompt]</a>			User account section
✓ F X S	✓	✓	✓	✓	mode=read_only		read_only or off	Enable (read_only) or disable readback of IP parameters on an FXS Vega when the handset is lifted and #1#1 is dialed

## 6.8 Advanced configuration entries

The following configuration entries are to be used for advanced setup of the product. The section [ `_advanced` ] is not listed by using wildcard section names from the `SHOW` command; it must be explicitly specified by typing `SHOW _advanced`, or by specifying the whole subsection/parameter path required.

FXS / FXO	BRI	V400	H323	SIP	Section/Parameter	Activate	Range	Comments
					[ <code>_advanced</code> ]			Advanced section
✓	✓	✓	✓	✓	<code>auto_apply=0</code>		0 or 1	1 = Automatically action an APPLY following each SET command
✓	✓	✓	✓	✓	<code>blocking_cause=34</code>	APPLY	1-127	Cause code returned to caller when incoming calls are blocked.
✓	✓	✓	✓	✓	<code>boot_debug=3</code>		0 to 3	Save diagnostic state for next reboot 0 = debug disabled, 1 = Radvision debug level 1 (info only) enabled 2 = Radvision debug level 4 (detail) enabled 3 = debug disabled, and ask for code selection at start up
✓	✓	✓	✓	✓	<code>oem_banner=0</code>	P,S/R	0 or 1	0 = standard banner 1 = more generic / non Vega banner on web browser
✓	✓		✓	✓	<code>temp_alert_action=none</code>		none / block / fxs_shutdown	If an over-temperature condition is observed, should calls be blocked, the system allowed to continue normal operation, or should all FXS ports be shutdown.
✓	✓	✓	✓	✓	<code>web_prefix=file:</code>			For Engineering Use Only
					[ <code>_advanced.autoexec</code> ]			
✓	✓	✓	✓	✓	<code>enable=1</code>		0 or 1	Disable / enable autoexec functionality
✓	✓	✓	✓	✓	<code>lastconfig=none</code>		alpha numeric string	Internal storage for autoexec function (stores last loaded config reference); there is typically no need to alter this parameter
✓	✓	✓	✓	✓	<code>scriptfile1=%mscript.txt</code>		alpha numeric string <=31 characters	Primary filename to use for autoexec script %i = IP address %m = MAC address %n = Name of Vega (lan.name) %p = product type
✓	✓	✓	✓	✓	<code>scriptfile2=defaultscript.txt</code>		alpha numeric string <= 31 characters	Secondary filename to use for autoexec script
					[ <code>_advanced.cause_mapping</code> ]			Translation for Q.850 cause codes (see IN 18 for cause code details)



FXS / FXO	BRI	V400	H323	SIP	Section/Parameter	Activate	Range	Comments
					<b>[_advanced.debug]</b>			<b>Advanced diagnostic information</b>
✓	✓	✓	✓	✓	content=0	S/R	0-255	For engineering use only, do not change
✓	✓	✓	✓	✓	entity=0	S/R	0-255	For engineering use only, do not change
✓	✓	✓	✓	✓	entity_watchdog=on	S/R	1 to 64 characters	For engineering use only, do not change
✓	✓	✓	✓	✓	entity2=0	S/R	0-255	For engineering use only, do not change
✓	✓	✓	✓	✓	module=0	S/R	0-255	For engineering use only, do not change
✓	✓	✓	✓	✓	module2=0	S/R	0-255	For engineering use only, do not change
✓	✓	✓	✓	✓	watchdog=on	S/R	on or off	For engineering use only, do not change
					<b>[_advanced.dsl.port.1.]</b>			
	✓	✓	✓	✓	tunnel_protocol.1.cpn=off			
					<b>[_advanced.dsp]</b>			
✓	✓	✓	✓	✓	allocation_mode=best_match	APPLY	best_match, least_used, least_used_all, least_used_50	<p>best_match: Vega allocates a channel on a DSP which already has channels allocated as long as it has the correct DSP image and there is space on the DSP for a new channel of the type being opened. (This ensures that on systems which have multiple DSP images, each with only a subset of the full complement of codecs, there is minimal chance of trying to allocate a channel for a specific codec and finding that no DSP has a free channel which can run that codec.</p> <p>least_used: this allows for a more even spread of the call loading on the DSPs within the system; Vega allocates a channel on a DSP which is least loaded. However, in order to preserve the ability to switch compressed CODEC types the last 1 (or, in the case of 5441 DSPs which work as pairs, the last 2) DSP(s) will be reserved and no channel will be allocated on this/these DSP(s) until all the other DSPs are 100% loaded.</p> <p>least_used_all: same as least_used except no DSPs are reserved for switching to another compressed CODEC.</p> <p>least_used_50: same as least_used but the reserved DSPs will only be used if all the other DSPs in the system are 50% or more loaded.</p>
✓	✓	✓	✓	✓	auto_restart=1		string <= 63 characters	<p>If no call is in progress on a DSP core whose ID is in the auto_restart list, 0.5 seconds after the last call cleared that DSP core will be rebooted.</p> <p>Auto_restart accepts " " or NULL for no entry, and comma separated DSP IDs or ranges denoted using the minus sign.</p> <p>e.g. 1,2,4-6 = DSPs 1,2,4,5,6</p>
✓	✓	✓	✓	✓	disable=none		string <= 63 characters	For engineering use only, do not change

FXS / FXO	BRI	V400	H323	SIP	Section/Parameter	Activate	Range	Comments
✓	✓	✓	✓	✓	dtmf_cadence_off_time=60	APPLY	25 to 10000	Off time for outgoing DTMF tones
✓	✓	✓	✓	✓	dtmf_cadence_on_time=90	APPLY	25 to 10000	On time for outgoing DTMF tones
✓	✓	✓	✓	✓	dtmf_hi_gain=11500	APPLY	0 to 32767	Relative amplitude for the high frequency part of the outgoing DTMF tone N.B. Changing this value from default may cause the Vega to produce out-of-spec DTMF tones. [Gain = $(20 \cdot \log_{10}(\text{value}/32767)) + 3$ ]
✓	✓	✓	✓	✓	dtmf_lo_gain=9500	APPLY	0 to 32767	Relative amplitude for the low frequency part of the outgoing DTMF tone N.B. Changing this value from default may cause the Vega to produce out-of-spec DTMF tones. [Gain = $(20 \cdot \log_{10}(\text{value}/32767)) + 3$ ]
✓	✓	✓	✓	✓	dtmf_threshold=-80	APPLY	-80 to 0	Ignore DTMF tones if they are below <dtmf_threshold> dBm - applies to in-call out-of-band dtmf detection, this parameter does not affect the call set up on FXS units  -80, the default, is effectively never ignore DTMF tones
✓	✓	✓	✓	✓	<a href="#">fax_disconnect_delay</a> =200	IMM	0 to 10000	Delay between receiving disconnect and actually ending call
✓	✓	✓	✓	✓	mf_cadence_on_time=60			Off time for outgoing MF tones
✓	✓	✓	✓	✓	mf_cadence_off_time=90			On time for outgoing MF tone
✓	✓	✓	✓	✓	mf_hi_gain=11500	APPLY	0 to 32767	Relative amplitude for the high frequency part of the outgoing MF tone N.B. Changing this value from default may cause the Vega to produce out-of-spec DTMF tones. [Gain = $(20 \cdot \log_{10}(\text{value}/32767)) + 3$ ]
✓	✓	✓	✓	✓	mf_lo_gain=9500	APPLY	0 to 32767	Relative amplitude for the low frequency part of the outgoing MF tone N.B. Changing this value from default may cause the Vega to produce out-of-spec DTMF tones. [Gain = $(20 \cdot \log_{10}(\text{value}/32767)) + 3$ ]
✓	✓	✓	✓	✓	poll_interrupt=1	APPLY	0 or 1	For engineering use only, do not change
✓	✓	✓	✓	✓	poll_period=8	APPLY	3 to 400	For engineering use only, do not change
✓	✓	✓	✓	✓	rtp_pkt_buffer=4	APPLY	0 to 10	Enable use of an extended RTP packet buffer to buffer packets before they are sent to the DSP: 0=off, 1 to 10 sets maximum buffer size.
✓	✓	✓	✓	✓	t38_diags=0	IMM	0 or 1	Enable detailed diagnostics for T.38 - For engineering use only, do not change.
					<b>[_advanced.dsp.buffering.fax]</b>			
7.5	7.5	7.5	7.5	7.5	depth=100		10 ... 200	T.38 packet resynchronisation buffer depth
7.5	7.5	7.5	7.5	7.5	enable=0		0 or 1	Disable / enable T.38 packet resynchronisation
					<b>[_advanced.dsp.buffering.vo]</b>			

FXS / FXO	BRI	V400	H323	SLIP	Section/Parameter	Activate	Range	Comments
					ice]			
7.5	7.5	7.5	7.5	7.5	depth=60		10 ... 120	voice packet resynchronisation buffer depth
7.5	7.5	7.5	7.5	7.5	enable=0		0 or 1	Disable / enable T.38 packet resynchronisation
					<a href="#">[_advanced.incoming_cause_mapping]</a>			Translation for Q.850 cause codes (see 'IN 18 Q.850 Cleardown cause codes' for cause code details)
					<a href="#">[_advanced.incoming_cause_mapping.1]</a>			Override values for cleardown cause codes.
7.5	7.5	7.5	7.5	7.5	name=default	IMM	Length<32	Name of this cause mapping list - for self documentation purposes
7.5	7.5	7.5	7.5	7.5	C1=1	APPLY	1-127	Cx=y substitutes the cause code y when the cause code x is supplied.
7.5	7.5	7.5	7.5	7.5	C2=2	APPLY	1-127	"
					-			
7.5	7.5	7.5	7.5	7.5	C127=127	APPLY	1-127	"
					<a href="#">[_advanced.h323]</a>			
✓	✓	✓	✓		RAS_h225_version=0	S/R	0 to 3	Set the h.225 version that is output in the Gatekeeper RAS messages. 0 means the real (RAD stack) version number is reported, other values force an artificial value.
✓	✓	✓	✓		rtd_failure_cause=41	S/R	1 to 127	Round trip delay failure cause code
FXO			✓		nocallerid=No_Caller_ID		alpha numeric string	If no caller ID is received (typically from incoming POTS FXO) then use this string as the caller ID name in an ongoing H323 call.
FXO			✓		notavail=Not_Available		alpha numeric string	if caller ID is not available then use this string as the caller ID name in an ongoing H323 call.
FXO			✓		restricted=Caller_ID_Blocked		alpha numeric string	if the caller ID is blocked then use this string as the caller ID name in an ongoing H323 call.
					<a href="#">[_advanced.h450]</a>			H.450 parameters
✓	✓		✓		max_calls=30		0 to 240	For Engineering use only, do not change
✓	✓		✓		max_services=30		0 to 240	For Engineering use only, do not change
					<a href="#">[_advanced.h450.h450_2]</a>			Parameters for H.450_2
			✓		timer_ct-t1=20			For Engineering use only, do not change
			✓		timer_ct-t2=22			For Engineering use only, do not change
			✓		timer_ct-t3=24			For Engineering use only, do not change

FXS / FXO	BRI	V400	H323	SIP	Section/Parameter	Activate	Range	Comments
			✓		timer_ct-t4=26			For Engineering use only, do not change
					[_advanced.h450.h450_3]			Parameters for H.450_2
			✓		timer_t1=20			For Engineering use only, do not change
			✓		timer_t2=22			For Engineering use only, do not change
			✓		timer_t3=24			For Engineering use only, do not change
			✓		timer_t4=26			For Engineering use only, do not change
			✓		timer_t5=28			For Engineering use only, do not change
					[_advanced.isdn]			Note: some of these parameters are appropriate to CAS signalling too.
	✓	✓	✓	✓	<a href="#">alert_with_progress=1</a>	APPLY	0, 1 or 2	0= ignore / 1= accept / 2= assume : in-band media indicator in ISDN ALERTING messages  Only supported on ISDN; CAS signalling schemes do not support an inband media indication
	✓		✓	✓	call_proceeding_with_progress=1	APPLY	0 or 1	Enable passage of in-band (audio) information on call proceeding.  Applies to both CAS and ISDN.
	✓	✓	✓	✓	connect_datetime=off		off, nt, te, always	Include 'date and time' IE in ISDN connect message:  off: never nt: on calls on NT ports te: on calls on TE ports always: on all calls
	✓	✓	✓	✓	disc_with_progress=1	APPLY	0 or 1	Enable passage of in-band (audio) information on call disconnect.  Applies to both CAS and ISDN.
	✓	✓	✓	✓	force_disconnect_progress=0	S/R	0 to 30	Time to play tone (in seconds)  N.B. this only operates on a Vega NT interface  Normally when a disconnect is sent to an ISDN call leg (from the Router / dial planner) if there is no tone indicated as being present (disconnect without progress) then a Disconnect is sent on the ISDN connection and no tone is played. If this parameter is set to a non zero value, the Vega will send a Disconnect with Progress message and play a tone out for the configured duration.  If the caller does not clear down, the Vega sends a Release 30 seconds after the disconnect with progress (T306 timer). Setting this parameter to anything other than 0 or 30 will leave the caller listening to silence after the played tone if they do not clear down.

FXS / FXO	BRI	V400	H323	SIP	Section/Parameter	Activate	Range	Comments
	✓	✓	✓		IEs_to_tunnel=08,1c,1e,20,24,28,29,2c,34,40,6d,71,78,7c,7d,7e,96		Comma separated list of IEs	List of IEs to tunnel when Tunnelling of specific information elements has been enabled.  See table in section <a href="#">10.5.3 "Tunnelling full signalling messages and IEs in ISDN (ETSI, ATT, DMS, DMS-M1, NI, VN 3/4) and QSIG"</a> for details of interactions of various parameters with IEs_to_tunnel.
		✓	✓		int_id_present=0	APPLY	0 or 1	Channel ID Information Element: "IntID Present field" in outgoing messages is defined:  0 = implicitly 1 = explicitly (see <a href="#">_advanced.isdn.interface_id</a> )
		✓	✓	✓	interface_id=0	APPLY	0 to 2	If <a href="#">_advanced.isdn.int_id_present</a> = 1, then:  <a href="#">interface_id</a> → the Channel ID Information Element: "Interface ID" in outgoing ISDN messages
		✓	✓	✓	link_error_count=0		0..16	0: function disabled  1..16: count of cumulative (not necessarily consecutive) frame errors before link is removed and restored to try and correct the problem
		✓	✓	✓	link_error_drop_time=2000		1..60000	Number of milliseconds to drop the ISDN link for under error conditions to allow it to clear and re-start (triggered by <a href="#">link_error_count</a> frame errors being reached)
	✓	✓	✓	✓	nt_alt_chan_if_collision=1		0 or 1	If two calls each attempt to use the same channel, or a new call is set up and tries to use a channel which has not yet cleared, either the NT end or the TE end can change the proposed channel for use. Typically this channel conflict resolution is carried out by the NT device, but this parameter allows the Vega to be configured to action the resolution as a TE.  0 = TE device to apply the resolution 1 = NT device to apply the resolution
	✓	✓	✓	✓	<a href="#">progress_with_progress</a> =1	APPLY	0, 1 or 2	0= ignore / 1= accept / 2= assume : in-band media indicator in ISDN PROGRESS messages  Only supported on ISDN; CAS signalling schemes do not support an inband media indication
		✓	✓		<a href="#">qsig_mode</a> =non_contiguous	APPLY	contiguous/ non_contiguous	For E1 systems it is necessary to select the Uq numbering scheme - to be the same as the QSIG device to which the Vega is attached  contiguous = Uqs 1..30 non-contiguous = Uqs 1..15 and 17..31
	✓	✓	✓	✓	send_display_as=display		none / display / facility	none = no display information will be sent out over ISDN

FXS / FXO	BRI	V400	H323	SIP	Section/Parameter	Activate	Range	Comments
								display = display information sent to ISDN will be in a display IE facility = display information sent to ISDN will be in a facility IE Note 1. This parameter affects all E1T1 AND BRI LINKSs on the gateway Note 2. As per Q.931 DISPLAY is only handled NT to TE (it is not handled TE to NT)
	✓	✓	✓	✓	<a href="#">send_progress_as_alerting=0</a>		0 or 1	0 = progress message passed through 1 = On receiving a progress message from an ISDN interface convert it to an alerting message before forwarding to the VoIP interface or another ISDN interface.
✓	✓	✓	✓	✓	tn_heap_debug	APPLY	0 or 1	For engineering use only, do not change
	✓	✓	✓	✓	<a href="#">user_dialtone=0</a>	APPLY	0 or 1	If set to 1, TE E1T1S OR BRISs will generate dial tone Only supported on ISDN (CAS does not support dial tone generation)
	✓	✓	✓	✓	<a href="#">user_progress=0</a>	APPLY	0 or 1	If set to 1, TE E1T1S OR BRISs will generate progress tones for alerting and disconnect Applies to both CAS and ISDN.
	✓	✓	✓	✓	verify_IEs=1			0: disables checking of IE types (and contents of those IEs) (See section <a href="#">10.3.5 "Verifying ISDN IEs (Information Elements)"</a> for more details)
	✓	✓	✓	✓	verify_IE_contents=1			0: disables checking of contents of IEs (See section <a href="#">10.3.5 "Verifying ISDN IEs (Information Elements)"</a> for more details)
					<b>[_advanced.isdn.mwi]</b>			
		✓		✓	type=normal	APPLY	normal / ericsson	Use standard QSIG messaging for MWI (Message Waiting Indication) or use Ericsson proprietary method
					<b>[_advanced.isdn.mwi.ericsson]</b>			
		✓		✓	ASF_IE_ID=127	APPLY	0 - 255	Configure the Ericsson specific ASF_IE_ID to be used in MWI message from Vega
		✓		✓	PBX_Protocol_ID=254	APPLY	0 - 255	Configure the Ericsson specific PBX protocol ID to be used in MWI message from Vega
		✓		✓	system_ID=0	APPLY	0 - 255	Configure the Ericsson specific system ID to be used in MWI message from Vega
					<b>[_advanced.isdn.untromboning]</b>			
					type=normal	APPLY	normal	

FXS / FXO	BRI	V400	H323	SIP	Section/Parameter	Activate	Range	Comments
					<b>[_advanced.lan]</b>			Advanced LAN parameters
✓	✓	✓	✓	✓	dns_rev_enable=0	S/R	0 or 1	Disable/enable reverse DNS lookup facility
✓	✓	✓	✓	✓	help_path=Help/default/usrguide/framedefn.htm		Alpha numeric string of chars	Path to access help files. (N.B. use forward slashes "/" not back slashes "\")
✓	✓	✓	✓		h323_push_enable=1	S/R	0 or 1	Disable/enable PUSH bit to expedite H.323 TCP signalling packets
✓	✓	✓	✓	✓	link_down_cause=38	S/R	0 to 127	Cause code returned if a call is attempted on the LAN interface and the physical layer is down
✓	✓	✓	✓	✓	rtp_checksum_enable=1	S/R	0 or 1	Disable/enable generation of UDP checksum for RTP packets
✓	✓	✓	✓	✓	tcp_max_retries=2	S/R	0 to 10	Max retries for TCP connections
✓	✓	✓	✓	✓	tcp_max_time=4	S/R	0 to 60	Max timeout for TCP connections
✓	✓	✓	✓	✓	tcp_push_enable=0	S/R	0 or 1	Disable/enable PUSH bit to expedite TELNET packets
✓	✓	✓	✓	✓	udpMaxDatagrams=250	S/R	10..1000	Maximum number of UDP packets that may be queued on a UDP port. For engineering use only, do not change.
					<b>[_advanced.lan.port_range.1]</b>			IP port number ranges (up to 40 entries allowed)
✓	✓	✓	✓	✓	max=19999		0 to 65535	Maximum IP port number in this range
✓	✓	✓	✓	✓	min=10000		0 to 65535	Minimum port number in this range
✓	✓	✓	✓	✓	name=rtp_range1		String of between 1 and 31 chars	Name of this range - for self documentation purposes
✓	✓	✓	✓	✓	protocol=udp		tcp or udp	Protocol that this range refers to
					<b>[_advanced.lan.port_range.2]</b>			IP port number ranges (up to 40 entries allowed)
✓	✓	✓	✓	✓	max=19999		0 to 65535	Maximum IP port number in this range
✓	✓	✓	✓	✓	min=10000		0 to 65535	Minimum port number in this range
✓	✓	✓	✓	✓	name=t38_tcp_range1		String of between 1 and 31 chars	Name of this range - for self documentation purposes
✓	✓	✓	✓	✓	protocol=tcp		tcp or udp	Protocol that this range refers to
					<b>[_advanced.lan.port_range.3]</b>			IP port number ranges (up to 40 entries allowed)
✓	✓	✓	✓	✓	max=80		0 to 65535	Maximum IP port number in this range
✓	✓	✓	✓	✓	min=80		0 to 65535	Minimum port number in this range
✓	✓	✓	✓	✓	name=webserver		String of between 1 and 31	Name of this range - for self documentation purposes

FXS / FXO	BRI	V400	H323	SIP	Section/Parameter	Activate	Range	Comments
							chars	
✓	✓	✓	✓	✓	protocol=tcp		tcp or udp	Protocol that this range refers to
					[_advanced.lan.port_range.4]			IP port number ranges (up to 40 entries allowed)
✓	✓	✓	✓	✓	max=19999		0 to 65535	Maximum IP port number in this range
✓	✓	✓	✓	✓	min=10000		0 to 65535	Minimum port number in this range
✓	✓	✓	✓	✓	name=t38_udp_range1		String of between 1 and 31 chars	Name of this range - for self documentation purposes
✓	✓	✓	✓	✓	protocol=udp		tcp or udp	Protocol that this range refers to
					[_advanced.lan.port_range.5]			IP port number ranges (up to 40 entries allowed)
✓	✓	✓	✓	✓	max=5060		0 to 65535	Maximum IP port number in this range
✓	✓	✓	✓	✓	min=5060		0 to 65535	Minimum port number in this range
✓	✓	✓	✓	✓	name=sip_udp		String of between 1 and 31 chars	Name of this range - for self documentation purposes
✓	✓	✓	✓	✓	protocol=udp		tcp or udp	Protocol that this range refers to
					[_advanced.lan.port_range.6]			IP port number ranges (up to 40 entries allowed)
✓	✓	✓	✓	✓	max=5060		0 to 65535	Maximum IP port number in this range
✓	✓	✓	✓	✓	min=5060		0 to 65535	Minimum port number in this range
✓	✓	✓	✓	✓	name=sip_tcp		String of between 1 and 31 chars	Name of this range - for self documentation purposes
✓	✓	✓	✓	✓	protocol=tcp		tcp or udp	Protocol that this range refers to
					[_advanced.lan.port_range_list.1]			Lists of IP port number ranges (up to 100 entries allowed)
✓	✓	✓	✓	✓	list=1		1 to 40	Comma separated list of ranges (allows non contiguous blocks of port numbers to be defined)
✓	✓	✓	✓	✓	name=rtp_ports		String of between 1 and 31 chars	Name of this list of ranges - for self documentation purposes
					[_advanced.lan.port_range_list.2]			Lists of IP port number ranges (up to 100 entries allowed)
✓	✓	✓	✓	✓	list=2		1 to 40	Comma separated list of ranges (allows non contiguous blocks of port numbers to be defined)
✓	✓	✓	✓	✓	name=t38_tcp_ports		String of between 1	Name of this list of ranges - for self documentation purposes



FXS / FXO	BRI	V400	H323	SIP	Section/Parameter	Activate	Range	Comments
							and 31 chars	
					[_advanced.lan.port_range_list.3]			Lists of IP port number ranges (up to 100 entries allowed)
✓	✓	✓	✓	✓	list=4		1 to 40	Comma separated list of ranges (allows non contiguous blocks of port numbers to be defined)
✓	✓	✓	✓	✓	name=t38_udp_ports		String of between 1 and 31 chars	Name of this list of ranges - for self documentation purposes
					[_advanced.lan.telnet]			
✓	✓	✓	✓	✓	port=23		1 to 65535	Port number on which Vega will accept telnet traffic
					[_advanced.lan.webserver]			
					[_advanced.logger]			
✓	✓	✓	✓	✓	log_in_secs=0	S/R	0 or 1	The time stamp in log messages is now accurate to milliseconds (this is the default behaviour). To revert back to the previous format for seconds resolution only set this value to 1.
✓	✓	✓	✓	✓	options=default			For Engineering use only
✓	✓	✓	✓	✓	task_priority=low	S/R	low, default	Set priority of logging task. Should only be used under direction of VegaStream approved support personnel.
					[_advanced.media]			
✓	✓	✓	✓	✓	control=fax	IMM	data, fax, ignore	data: use G.711 data rather than T.38 codec for modem and fax calls fax: use T.38 or G.711 for fax / modem calls. T.38 for G3 fax (V.25 tone followed by V.21 tone), and G.711 for Super G3 fax (phase reversed V.25 tone) and modem (V.25 tone but no V.21 tone) ignore: ignore the V.25 tone
✓	✓	✓	✓	✓	direct_TDM_enable=1	APPLY	0 or 1	0 = For loopback telephony to telephony calls, loop the audio back on the packet side of the DSP (i.e. after applying codec and gain functionality of the dsp) 1 = For loopback telephony to telephony calls pass the media directly from port/channel to port/channel (i.e. loop it as TDM data without passing it to/through the DSPs).
✓	✓	✓		✓	dynamic_codec_switch=off	APPLY	off, on	When enabled the Vega will dynamically change its transmitted codec to match what is being received.
✓	✓	✓	✓		enforce_pkt_time_boundaries=1	APPLY	0 or 1	0 = do not validate that the H.323 packet time is within the range that can be

FXS / FXO	BRI	V400	H323	SIIP	Section/Parameter	Activate	Range	Comments
								processed by the Vega - used where the Vega is being connectd to by devices who populate the packet time field wrongly (field is in units of 10ms, not lms!)  1 = usual setting - do check that packet time is valid
✓	✓	✓	✓	✓	rtp_port_range_list=1		0 to 100	Index into <code>_advanced.lan.port_range_list.x</code> that defines the list of ranges of IP port numbers to use for RTP
✓	✓	✓	✓	✓	rx_udp_source_check=0	CALL	0 or 1	0 = Normal mode of operation - RTP packets arriving on the agreed local IP port will be played to the telephony interface  1 = Before RTP packets arriving on the agreed local IP port are played, they are checked to see that they have originated from the expected remote endpoint IP address and IP port number. Note: the remote endpoint MUST send and receive RTP data for that call on the same IP port.
✓	✓	✓	✓	✓	sysload=85			For engineering use only, do not change
✓	✓	✓	✓	✓	sysload_period=400			For engineering use only, do not change
					<b>[_advanced.mods]</b>			
✓	✓	✓	✓	✓	bits=0x0000	CALL	1 to 33 characters	For engineering use only, do not change
					<b>[_advanced.outgoing_cause_mapping.1]</b>			Override values for cleardown cause codes. For details on what the codes mean, see Information Note 'IN18 Q850 cleardown cause codes'
✓	✓	✓	✓	✓	name=default	IMM	Length<32	Name of this cause mapping list - for self documentation purposes
✓	✓	✓	✓	✓	C1=1	APPLY	1-127	Cx=y substitutes the cause code y when the cause code x is supplied.
✓	✓	✓	✓	✓	C2=2	APPLY	1-127	"
✓	✓	✓	✓	✓	-			
✓	✓	✓	✓	✓	C127=127	APPLY	1-127	"
					<b>[_advanced.pacing.1]</b>			
✓	✓	✓	✓	✓	delay=5	S/R	1..10000	For Engineering use only, do not change
✓	✓	✓	✓	✓	threshold=120	S/R	1..1000	For Engineering use only, do not change
					<b>[_advanced.pots]</b>			
✓			✓	✓	poll_timer=15	S/R	5 to 1000	Polling interval used within POTS firmware (milliseconds) - For engineering use only, do not change
✓				✓	save_pots_user_status=off	APPLY	on, off	If enabled the Vega will try to save a txt file containing the statuses of the supplementary services (DND, call forward, etc) for each port to the

FXS / FXO	BRI	V400	H323	SLIP	Section/Parameter	Activate	Range	Comments
								default TFTP, FTP, HTTP or HTTPS server.
					[_advanced.pots.fxo.1]			FXO hardware interface configuration (up to 10 entries)
FXO			✓	✓	call_connection_time=30			FXO disconnect supervision time that must expire before clear-down tones will be looked for
FXO			✓	✓	digital_rx_gain=0	APPLY	-18 .. 6	Db level for input gain on FXO port
FXO			✓	✓	digital_tx_gain=0	APPLY	-18 .. 6	Db level for output gain on FXO port
FXO			✓	✓	dtmf_holdoff_time=1500	APPLY	0 to 10000	Time in milliseconds to wait before playing DTMF after offhook
FXO			✓	✓	early_line_seize=0		0 or 1	0 = a call coming in from the POTS side will wait for the LAN side to connect before the Vega FXO port seizes the POTS line.  1 = the Vega FXO port will answer ("pick up") any incoming POTS call immediately ringing is detected.
FXO			✓	✓	early_line_seize_to=30		0 to 1000	If early_line_seize=1 and early_line_seize_to is non-zero, a timer will be started when ring tone has been detected. The timer stops when the call is connected on the LAN side. If, the timer exceeds the configured timeout value then the call is automatically disconnected.  Note - for calls that are abandoned by the calling party, where there is no disconnect supervision, the line will remain seized until the timeout is reached, so closely following calls will find the line busy).  If early_line_seize=1 and early_line_seize_to=0, the timer does not run and so a call into the FXO telephony interface will not be dropped until the LAN side connects then disconnects.
✓			✓	✓	force_disconnects=1	APPLY	0 or 1	Force an off-hook then an on-hook if call is dropped before POTS FXO answers
✓			✓	✓	hookflash_time=200	APPLY	0 to 10000	Period for hookflash generation (milliseconds)
✓			✓	✓	impedance=ctr21	S/R	ctr21, default, 600R, 900R	Specifies the hardware impedance of the FXO line interface
FXO			✓	✓	line_reversal_debounce_time=50	APPLY	0 to 10000	Specify the time in milli seconds to pause to debounce the line reversal signal (allow the line reverse voltage to maintain a steady state after a change)
✓			✓	✓	line_reversal_detect=0	APPLY	0 or 1	Enable line reversal detection (aka battery reversal)
✓			✓	✓	loop_current_detect=0	APPLY	0 to 10000	0: disable loop current detection of clear-down

FXS / FXO	BRI	V400	H323	SLIP	Section/Parameter	Activate	Range	Comments
								>0: Enable loop current detection of clear-down - parameter value = time in ms, which if exceeded indicates a call clear.
✓			✓	✓	port_not_released_cause=34	APPLY	1 to 127	Cause code returned if a new call is presented to a POTS port before its port_release_delay has expired. (Use this in a group definition to re-present the call to another port).
✓			✓	✓	port_release_delay=0	APPLY	0 to 32	Delay (in seconds) after POTS line clears before Vega will allow a new call to be placed through this port again - this avoids failed calls on lines which take a long time to clear, e.g. on GSM lines it can take up to 20s for the line to clear
FXO			✓	✓	ring_detect_longest_ring_of f=2000		100 .. 10000	Detecting no ringing for >= this value indicates a call has stopped ringing on a Vega FXO port - if the call has not been answered, the call will be cleared.
FXO			✓	✓	ring_detect_shortest_ring_o n=400		100 .. 20000	Detecting ringing for >= this value indicates a call arrival to a Vega FXO port
FXO			✓	✓	ringback_present=1		0 or 1	0: On an FXO outbound call, ringback tone is passed to the VoIP interface until the FXO answer is received  1: On an FXO outbound call, audio from the FXO line is passed across the VoIP interface as soon "early media" allows audio to be transferred  Note: On standard loopstart lines, the "answer" occurs on seizing the FXO line, so all dialling etc. will be heard whatever the value of this parameter. On line current reversal lines ringback tone will be heard until answer if this parameter is set to 0.
FXO			✓	✓	tone_detect=0			FXO disconnect supervision enable
FXO			✓	✓	voice_detect=0		0 or 1	Enable / disable voice based answer detection
FXO			✓	✓	voice_detect_delay=0		0 or 10000	Delay listening for voice for 'n' ms to avoid treating echo from the Vega being detected as voice.
FXO			✓	✓	voice_detect_min_time=800			Time in ms that power level must be above voice_detect_power_threshold (after and ring tone has been detected) to indicate that there has been voice activity
FXO			✓	✓	voice_detect_power_threshol d=-60			Power threshold, above which audio is deemed to be voice
FXO			✓	✓	voice_lost_disc_time=0			0: Do not clear call based on silence detection  >0: Time in ms that power level must be below voice_detect_power_threshold for call to be cleared
FXS			FXS	FXS	wink_on_disconnect=0	APPLY	0 to 5000	0: No wink on disconnect  1 to 5000: wink time and wink guard time (e.g. if set to 500, Vega will wink for 500ms then return to line voltage for a minimum of 500ms)

FXS / FXO	BRI	V400	H323	SIP	Section/Parameter	Activate	Range	Comments
					[_advanced.pots.fxs.1]			FXS hardware interface configuration (up to 10 entries)
FXS			✓	✓	call_fwd_no_answer_timeout=15	APPLY	0-255	Time in seconds for which an FXS port will apply ringing before call forward no answer (CFNA) kicks in.
FXS			✓	✓	dialled_dtmf_detect=0	S/R		For engineering use only 0: use DSP to detect DTMF tones 1: use POTS chip to detect DTMF tones
FXS			✓	✓	digital_rx_gain=0	APPLY	-18 .. 6	Db level for input gain on FXS port
FXS			✓	✓	digital_tx_gain=0	APPLY	-18 .. 6	Db level for output gain on FXS port
FXS			✓	✓	dtmf_dialout_delay		0 .. 10000	Time to wait (in milli seconds) after answer before dialing any FXS outdial digits - specified in destination dial plan TEL:
FXS			✓	✓	hookflash_debounce_time=30	APPLY	0 to 10000	Minimum time in milliseconds for hookflash detection (line current loss for less than this time will be ignored).
FXS			✓	✓	hookflash_time=500	APPLY	0 to 10000	Maximum time in milliseconds for hookflash detection (line current loss for greater than this time will cause a call cleardown)
FXS			✓	✓	impedance=default	S/R	ctr21, default, 600R, 900R	Specifies the hardware impedance of the FXS interface
FXS			✓	✓	line_length=normal	S/R	normal, long	FXS ports can drive a line length of up to 8km (at 1 REN). Please contact the relevant technical support representative for using long drive lengths with REN loading of more than 1 REN. normal - Default - Line lengths up to 3km long - Line lengths up to 8km
FXS			✓	✓	line_reversal=0	APPLY	0 or 1	Enable line reversal generation (aka battery reversal)
FXS			✓	✓	loop_current_break=off	APPLY	off or on	Disable or enable Loop Current Disconnect generation on FXS ports to indicate that the other caller has cleared
FXS			✓	✓	loop_current_delay=9000	APPLY	0 to 100000	Time in milliseconds before Loop Current is dropped after the far end has cleared. (This gives the caller on the FXS port time to clear their side of the call before the Vega indicates call drop)
FXS			✓	✓	loop_current_time=300	APPLY	300 to 10000	Period that the Vega will drop the Loop current for (in milliseconds) to indicate other party has cleared ... see also loop_current_transition_time
FXS			✓	✓	loop_current_transition_time=10	APPLY	0 to 100	When removing loop current, line capacitance can delay the drop. Vega actually drops the line current for loop_current_time + loop_current_transition_time

FXS / FXO	BRI	V400	H323	SIP	Section/Parameter	Activate	Range	Comments
FXS			✓	✓	onhook_line_reversal=0		0 or 1	Enable onhook line reversal - a double reversal of the line voltage to acknowledging the loss of line current on the telephone interface (i.e. to acknowledge detection of the telephone line clearing down)
FXS			✓	✓	onhook_line_reversal_interval=300		30 to 10000	Duration between the first and second reversal of the clear-down acknowledge signal
FXS			✓	✓	visual_mwi=tone		none, tone, neon, both	None: no message waiting indication given tone: Use FSK modem burst to indicate to the phone that a message is waiting neon: use FXS line voltage to indicate a message waiting (to light a neon lamp) both: use FSK modem burst and FXS line voltage to indicate a message waiting
FXS			✓	✓	vring_rms=49.5		49.5, 60.5	Line voltage to supply on FXS port (49.5v rms = 70v pp, 60.5v rms = 85.5v pp)
FXS			✓	✓	wink_debounce_time=50		0 .. 5000	At the end of a call do a wink after wink_debounce_time after line current is removed
FXS			✓	✓	wink_time=500		0 .. 5000	At the end of a call do a wink for this period after the wink_debounce_time
					<b>[_advanced.pots.ring.1]</b>			Ring description table for FXS POTS ports (Power ringing)
✓			✓	✓	frequency=50	S/R	16, 20, 30, 40, 50, 60	Frequency to use for power ringing on FXS ports Note: 16 actually = 16.667Hz
✓			✓	✓	name=External_UK	S/R	Length<32	Power ringing cadence name - for self documentation purposes
✓			✓	✓	repeat=1	S/R	0 or 1	0 = play sequence ring1 ... ring3 through once only 1 = repeat cycling through the ring definitions ring1, 2, 3
✓			✓	✓	ring1_on=400	S/R	0-10000	Ring 1 on time
✓			✓	✓	ring1_off=200	S/R	0-10000	Ring 1 off time
✓			✓	✓	ring2_on=400	S/R	0-10000	Ring 2 on time
✓			✓	✓	ring2_off=2000	S/R	0-10000	Ring 2 off time
✓			✓	✓	ring3_on=0	S/R	0-10000	Ring 3 on time
✓			✓	✓	ring3_off=0	S/R	0-10000	Ring 3 off time
					<b>[_advanced.rad.debug]</b>			Debug
✓	✓	✓	✓		enable=0			For Engineering use only, do not change
✓	✓	✓	✓		filters=NULL	S/R	Length<32	For Engineering use only, do not change
✓	✓	✓	✓		startup=NULL			For Engineering use only, do not change

FXS / FXO	BRI	V400	H323	SIP	Section/Parameter	Activate	Range	Comments
					<b>[_advanced.rad.h225]</b>			Low level H.225 control
✓	✓	✓	✓		multicast_ip=224.000.001.041			IP address to send GRQ (multicast gatekeeper request) to
✓	✓	✓	✓		multicast_port=1718			IP port number to send GRQ (multicast gatekeeper request) to
✓	✓	✓	✓		rasPort=1719			IP port number on which Vega will listen for RAS messages
✓	✓	✓	✓		retries=3	S/R	1 to 5	Number of retries for Gatekeeper operations
✓	✓	✓	✓		timeout=4	S/R	0 to 20	Timeout period for Gatekeeper operations
✓	✓	✓	✓		tTl_advance=1			For Engineering use only, do not change
					<b>[_advanced.rad.h245]</b>			Low level H.245 control
✓	✓	✓	✓		capabilitiesTimeout=10			Timeout for H.245 set capabilities message not responded to
✓	✓	✓	✓		channelsTimeout=10			Timeout for H.245 open logical channel message not responded to
✓	✓	✓	✓		masterSlaveTimeout=10			Timeout for H.245 master / slave determination message not responded to
✓	✓	✓	✓		requestCloseTimeout=10			Timeout for H.245 close logical channel message not responded to
✓	✓	✓	✓		requestModeTimeout=10			Timeout for H.245 request mode message not responded to
✓	✓	✓	✓		roundTripTimeout=5	S/R	0 to 999	Round trip delay - time to wait for the RTD response after request has been sent
✓	✓	✓	✓		terminalType=0			Specifies the "terminalType" value presented in the H.245 master/slave exchange - the value 0 results in the default value "60" (gateway) being used.
					<b>[_advanced.rad.q931]</b>			Low level Q.931 control in H.323 messages
✓	✓	✓	✓		callSignallingPort=1720	S/R	1 to 65535	IP port number that the Vega will listen to for incoming H323 calls.
✓	✓	✓	✓		connectTimeout=120	S/R	1 to 9999	After an outgoing H323 call has been started, this is the time (in seconds) that the Vega will wait before disconnecting the call if it does not receive a connect message from the far end.
✓	✓	✓	✓		maxCalls=60			How many calls can be handled in the RAD stack
✓	✓	✓	✓		responseTimeout=5	S/R	1 to 9999	After an outgoing H323 call has been started, this is the time (in seconds) that the Vega will wait before it disconnects the call if it does not receive any response from the far end. This is most commonly used to clear the call when the far end or the system gatekeeper have been disconnected from the LAN.
					<b>[_advanced.rad.system]</b>			Low level h.323 system resource control

FXS / FXO	BRI	V400	H323	SIP	Section/Parameter	Activate	Range	Comments
					extraCalls=5			Rad stack resources - For engineering use only, do not change
					extraData=2048			Rad stack resources - For engineering use only, do not change
					extraNodes=50			Rad stack resources - For engineering use only, do not change
					maxBufferSize=20480		1024, 2048, 4096	Q.931 buffer resources - For engineering use only, do not change
					maxCalls=60			Rad stack resources - For engineering use only, do not change
					maxChannels=4			Rad stack resources - For engineering use only, do not change
					<b>[_advanced.rfc2833]</b>			N.B. Out of Band DTMF must be configured in the codec configuration for OTMF tones to be sent as RFC2833 messages
✓	✓	✓		✓	digit_mute_time=0	Apply	0 to 2000	0: no mute  >0 (ms): on echoey analogue lines the generation of DTMF tones by the vega can cause enough echo that tones are sent back to the originator. Adding a digit mute means that the reverse path is muted whilst the echo cancellor cuts in and itself removes the tone.
✓	✓	✓		✓	marker_bit=0	S/R	0 or 1	This parameter is only applicable if <b>_advanced.rfc2833.ones_shot=1</b> :  0 = ignore marker bit in received RFC2833 messages  1 = use marker bit in RFC2833 messages to indicate start of new events
✓	✓	✓		✓	<a href="#">one_shot</a> =1	IMM	0 or 1	This parameter controls how the Vega will generate DTMF tones when it receives RFC2833 DTMF messages.  0 = the true duration of the DTMF tones (that the far end detector detected) will be played  1 = single fixed length DTMF tone pulses will be played however long the original tones were (tone on period is defined by dtmf_cadence_on_time)
✓	✓	✓		✓	tx_volume=10	S/R	0 to 63	Power level of tone reported in Tx RFC2833 packets = -n dBm0 (e.g. 10 means -10dBm0). RFC2833 says tones with a power 0 to -36dBm0 must be accepted, and below -55dBm0 must be rejected. If tx_volume is set above 63 then a value '36' is put in the RFC2833 messages
					<b>[_advanced.setup_mapping]</b>			Mapping of SETUP message elements (Vega ISDN ports and All Vega H.323 setup messages).
					<b>[_advanced.setup_mapping.1]</b>			
H323	✓	✓	✓	IS	name=default	IMM	Length<32	Name of setup mapping list - for self



FXS / FXO	BRI	V400	H323	SIP	Section/Parameter	Activate	Range	Comments
				DN				documentation purposes
					<a href="#">[_advanced.setup_mapping.1.bearer_capability]</a>			
					ll_protocol=supplied		supplied/ v110/ u_law/ a_law/ adpcm/ non_ccitt/ v120/ x31/ unused	Override Layer 1 protocol value in outgoing setup message (to ISDN or H.323)
		✓	✓	✓	transfer_capability=speech		supplied/ speech/ unresDigital/ resDigital/ 3.1khz/ unresDigitalTones	Override transfer capability value in outgoing setup message (to ISDN or H.323)
		✓	✓	✓	transfer_mode=supplied		supplied/ circuit/ packet	Override transfer mode value in outgoing setup message (to ISDN or H.323)
		✓	✓	✓	transfer_rate=supplied		supplied/ packet/ 64kbit/ 2x64kbit/ 384kbit/ 1536kbit/ multirate	Override transfer rate value in outgoing setup message (to ISDN or H.323)
					user_rate=supplied		supplied/ 56kbps/ 64kbps/ unused	Override user rate value in outgoing setup message (to ISDN or H.323)
					<a href="#">[_advanced.setup_mapping.1.called_party_number]</a>			
H323	✓	✓	✓	ISDN	plan=supplied	APPLY	Unknown/ isdn_telephony/ data/ telex/ national/ private/ supplied	Override the Numbering Plan Identification field value for setup messages (ISDN or H.323); supplied = do not override the NPI value (pass it through from the incoming call)
H323	✓	✓	✓	ISDN	type=supplied	APPLY	Unknown/ international/ national/ network_specific/ subscriber/ abbreviated/ supplied	Override the Type of Number field value for setup messages (ISDN or H.323); supplied = do not override the TON value (pass it through from the incoming call or planner.post_profile)

FXS / FXO	BRI	V400	H323	SIP	Section/Parameter	Activate	Range	Comments
					<a href="#">[_advanced.setup_mapping.1.calling_party_number]</a>			
H323	✓	✓	✓	ISDN	plan=supplied	APPLY	Unknown/ isdn_telephony/ data/ telex/ national/ private/ supplied	Override the Numbering Plan Identification field value for setup messages (ISDN or H.323); supplied = do not override the NPI value (pass it through from the incoming call)
H323	✓	✓	✓	ISDN	presentation=supplied	APPLY	Allowed/ restricted/ not_available / supplied	Override the Presentation Indicator field value for setup messages (ISDN or H.323); supplied = do not override the PI value (pass it through from the incoming call)
H323	✓	✓	✓	ISDN	screening=supplied	APPLY	not_screened/ passed/ failed/ supplied	Override the Screening Indicator field value for setup messages (ISDN or H.323); supplied = do not override the SI value (pass it through from the incoming call)
H323	✓	✓	✓	ISDN	type=supplied	APPLY	Unknown/ international/ national/ network_specific/ subscriber/ abbreviated / supplied	Override the Type Of Number field value for setup messages (ISDN or H.323); supplied = do not override the TON value (pass it through from the incoming call)
					<b>[_advanced.setup_mapping.1.nsf]</b>			Network-Specific Facilities information element (NSF IE) - sent in the ISDN SETUP message (if this feature is enabled) for NI1, NI2, DMS100 or 5ESS signalling schemes. (Format of NSF IE is as per Q.931 section 4.5.21)
		T1	✓	✓	coding=0	APPLY	0 to 31	Facility coding value
		T1	✓	✓	enable=0	APPLY	0 or 1	Enable the sending of the Network Specific Facilities information element
		T1	✓	✓	id=NULL	APPLY	<=32 characters	ASCII ID of NSF IE. If set to "NULL" the ASCII identifier, id_type and id_plan will not be included in the NSF IE.
		T1	✓	✓	id_plan=0	APPLY	0 to 15	id_plan value, included in NSF IE if id <> NULL
		T1	✓	✓	id_type=0	APPLY	0 to 7	id_type value, included in NSF IE if id <> NULL
		T1	✓	✓	service=1	APPLY	0 or 1	Service flag
					<b>[_advanced.sip]</b>			
✓	✓	✓		✓	anonymous_display_name=Anonymous	S/R	String <= 40 characters	Anonymous: when incoming ISDN call has caller ID presentation indicator marked as restricted, "display name" in From field in outbound SIP message

FXS / FXO	BRI	V400	H323	SIP	Section/Parameter	Activate	Range	Comments
								= 'Restricted user'  <> Anonymous: when incoming ISDN call has caller ID presentation indicator marked as restricted, this value specifies the name used as "display name" in From field in outbound SIP message
✓	✓	✓		✓	3xx_invite_to_proxy=0	S/R	0 or 1	0: send the redirected INVITE directly to the destination specified in the Contact: header in the 3xx message.  1: send the redirected INVITE to the default proxy (and default proxy port) no matter what is specified in the 3xx Contact: field.
✓	✓	✓		✓	bye_also_invite_to_proxy=0	S/R	0 or 1	0: send the INVITE directly to the destination specified in the "Also" header in the BYE  1: send the new INVITE to the default proxy no matter what is specified in the "Also" header in the BYE.
✓				✓	cisco_cm_compatibility=0	S/R	0 or 1	If enabled the Vega will use a different SIP signalling port for each of the FXS interfaces.
	✓	✓		✓	disc_if_progress_with_cause=0		0 or 1	0: function disabled  1: if a progress message with cause indication is received on ISDN then clear the call to SIP (e.g. if the called number is Out of Order then clear SIP call with SIP 500, Destination out of order) - this allows a SIP proxy to, for example, sequentially try other phones if the called party is unreachable at that destination.
✓	✓	✓		✓	disc_with_progress=0	APPLY	0 .. 6000	0: Disconnect SIP call if disconnect , even if disconnect with progress  1 .. 6000: Enable passage of in-band (audio) information on call disconnect - pass media through for a maximum of this number of seconds.
✓	✓	✓		✓	early_ok_timer=0	APPLY	0 .. 6000	0: function disabled  n: answer call with SIP OK after time n seconds (from the 18x message) if the call has not been answered on the telephony interface before then.  N.B. not for general use - typically used when connecting to ISDN endpoints known not to provide a Connect.
✓	✓	✓		✓	escape_chars_in_uri=0	APPLY	0 or 1	If enabled the Vega will escape any non-standard characters in SIP headers.
✓	✓	✓		✓	from_header_uri_params	APPLY	NULL / string up 39 chars	Allows strings to be appended to From header URI's, for example : ";user=phone" and ";user=dialstring"
✓	✓	✓		✓	ignore_udp_bye=0		0 or 1	For engineering use only, do not change
✓	✓	✓		✓	ignore_udp_invite=0		0 or 1	For engineering use only, do not change
✓	✓	✓		✓	<a href="#">international_prefix=off</a>	APPLY	off or digits	Off = no prefix will be added

FXS / FXO	BRI	V400	H323	SIP	Section/Parameter	Activate	Range	Comments
								if prefix digits are defined then these will be added to the front of the calling party number sent out in the SIP INVITE if the incoming ISDN TON=international. For further details see section <a href="#">8.11.3</a>
✓	✓	✓		✓	match_req_uri=1	APPLY	0 or 1	0: Do not use the "request-URI" when matching call legs 1: Include the "request-URI" when matching call legs
✓	✓	✓		✓	max_call_legs=120	S/R	0 - 140	Specify the maximum number of SIP call legs the Vega will handle before rejecting calls.
✓	✓	✓		✓	max_forks=3	APPLY	1..12	Maximum number of forked destinations supported by the Vega, per call
✓	✓	✓		✓	<a href="#">national_prefix=off</a>	APPLY	Off or digits	Off = no prefix will be added if prefix digits are defined then these will be added to the front of the calling party number sent out in the SIP INVITE if the incoming ISDN TON=national. For further details see section <a href="#">8.11.3</a>
✓	✓	✓		✓	outgoing_call_setup_to=15000		0 to 300000	With multiple proxies, and their respective timeouts, it is possible for the Vega to try for a long time to place a call if there are proxy problems. This parameter puts an upper limit on the time the Vega will try to make the call over SIP before rejecting the call back to the dial planner with reason code=3.  This can also be used for liming the maximum time the Vega will try to place the SIP call before re-presenting the call, for example over the telephony network
✓	✓	✓		✓	<a href="#">progress_if_media=2</a>	APPLY	0, 1 or 2	0: When an ISDN ALERTING message is received use the SIP 180 Ringing message to indicate ringing (an sdp will be present if in-band media is present)  1: When an ISDN ALERTING message is received with in-band media indication use the SIP 183 Session progress to indicate media in the RTP stream. If there is no in-band media indication then a SIP 180 Ringing message will be sent.  2: When an ISDN ALERTING message is received and audio is to be passed (whether media is generated locally or passed through from ISDN) use the SIP 183 Session Progress message to indicate media in the RTP stream. 180 will be used if no media is to be passed.
✓	✓	✓		✓	refer_invite_to_proxy=0		0 or 1	0 = send INVITE directly to the destination specified by the REFER 1 = send INVITE to the proxy when handling a REFER
✓				✓	rx_dtmf_to_hookflash=off	APPLY	off, 0-9,*,#	If non-zero the Vega will convert the specified DTMF indication received on SIP into a physical hookflash on an FXO port.
					sip_headers_form=long		short or	SIP headers can either be of the form To: and From:, typically whole words (long

FXS / FXO	BRI	V400	H323	SIP	Section/Parameter	Activate	Range	Comments
							long	form) or t: and f:, typically single letters (short form)
✓	✓	✓		✓	tel_srce=req_uri		req_uri or to_header	req_uri: TEL string presented to the dial plan is taken from the characters appearing between the "sip:" and the "@" of the request-URI.  to_header: TEL string presented to the dial plan is taken from the characters appearing between the "sip:" and the "@" of the To header.
✓	✓	✓		✓	to_header_uri_params	APPLY	NULL / string up 39 chars	Allows strings to be appended to To header URI's, for example : ";user=phone" and ";user=dialstring"
✓	✓	✓		✓	use_maddr_in_contact=0		0 or 1	0 = do not include maddr in the contact header 1 = include maddr in the contact header
✓	✓	✓		✓	user_agent_header=1		0 or 1	0 = no user agent header in SIP messages 1 = include user agent header in SIP messages, e.g.: User-Agent: Vega50-Wisc / 04.02.04xT025
✓	✓	✓		✓	user_agent_header_ext=NULL		Up to 80 characters	NULL = no extension to be added to the user-agent header anything else = appended to user-agent SIP header ... characters must be "token" characters as defined by RFC 3261
					<b>[_advanced.sip.access_network_info]</b>			
✓	✓	✓		✓	enable=0	APPLY	0,1	Populate P-Access-Network-Info with TDM bearer channel information.
					<b>[_advanced.sip.call_waiting]</b>			
✓				✓	status_code=off	APPLY	off, up to 8 characters	If not off then Vega will return the specified SIP message code to the waiting party.
✓				✓	status_text=NULL	APPLY	NULL, up to 64 characters	If not NULL then Vega will use the specified text in the textual part of the SIP message code in the ringing indication to the waiting party.
					<b>[_advanced.sip.cause_to_response_mapping]</b>			
✓	✓	✓		✓	C1=404	APPLY	400 .. 699	SIP response yyy is sent if clear-down cause code x is received.
✓	✓	✓		✓	C2=404	APPLY	400 .. 699	SIP response yyy is sent if clear-down cause code x is received.
✓	✓	✓		✓	C3=404	APPLY	400 .. 699	SIP response yyy is sent if clear-down cause code x is received.
✓	✓	✓		✓	C6=500	APPLY	400 .. 699	SIP response yyy is sent if clear-down cause code x is received.

FXS / FXO	BRI	V400	H323	SIP	Section/Parameter	Activate	Range	Comments
✓	✓	✓		✓	C7=500	APPLY	400 .. 699	SIP response yyy is sent if cleardown cause code x is received.
✓	✓	✓		✓	C16=480	APPLY	400 .. 699	SIP response yyy is sent if cleardown cause code x is received.
✓	✓	✓		✓	C17=486	APPLY	400 .. 699	SIP response yyy is sent if cleardown cause code x is received.
✓	✓	✓		✓	C18=480	APPLY	400 .. 699	SIP response yyy is sent if cleardown cause code x is received.
✓	✓	✓		✓	C19=480	APPLY	400 .. 699	SIP response yyy is sent if cleardown cause code x is received.
✓	✓	✓		✓	C21=603	APPLY	400 .. 699	SIP response yyy is sent if cleardown cause code x is received.
✓	✓	✓		✓	C22=410	APPLY	400 .. 699	SIP response yyy is sent if cleardown cause code x is received.
✓	✓	✓		✓	C26=404	APPLY	400 .. 699	SIP response yyy is sent if cleardown cause code x is received.
✓	✓	✓		✓	C27=500	APPLY	400 .. 699	SIP response yyy is sent if cleardown cause code x is received.
✓	✓	✓		✓	C28=484	APPLY	400 .. 699	SIP response yyy is sent if cleardown cause code x is received.
✓	✓	✓		✓	C29=501	APPLY	400 .. 699	SIP response yyy is sent if cleardown cause code x is received.
✓	✓	✓		✓	C30=500	APPLY	400 .. 699	SIP response yyy is sent if cleardown cause code x is received.
✓	✓	✓		✓	C31=404	APPLY	400 .. 699	SIP response yyy is sent if cleardown cause code x is received.
✓	✓	✓		✓	C34=500	APPLY	400 .. 699	SIP response yyy is sent if cleardown cause code x is received.
✓	✓	✓		✓	C38=500	APPLY	400 .. 699	SIP response yyy is sent if cleardown cause code x is received.
✓	✓	✓		✓	C41=500	APPLY	400 .. 699	SIP response yyy is sent if cleardown cause code x is received.
✓	✓	✓		✓	C42=503	APPLY	400 .. 699	SIP response yyy is sent if cleardown cause code x is received.
✓	✓	✓		✓	C43=500	APPLY	400 .. 699	SIP response yyy is sent if cleardown cause code x is received.
✓	✓	✓		✓	C44=500	APPLY	400 .. 699	SIP response yyy is sent if cleardown cause code x is received.
✓	✓	✓		✓	C47=503	APPLY	400 .. 699	SIP response yyy is sent if cleardown cause code x is received.
✓	✓	✓		✓	C49=500	APPLY	400 .. 699	SIP response yyy is sent if cleardown cause code x is received.
✓	✓	✓		✓	C50=500	APPLY	400 .. 699	SIP response yyy is sent if cleardown cause code x is received.
✓	✓	✓		✓	C57=403	APPLY	400 .. 699	SIP response yyy is sent if cleardown cause code x is received.
✓	✓	✓		✓	C58=501	APPLY	400 .. 699	SIP response yyy is sent if cleardown cause code x is received.
✓	✓	✓		✓	C63=500	APPLY	400 .. 699	SIP response yyy is sent if cleardown cause code x is received.
✓	✓	✓		✓	C65=501	APPLY	400 .. 699	SIP response yyy is sent if cleardown

FXS / FXO	BRI	VA00	H323	SIP	Section/Parameter	Activate	Range	Comments
								cause code x is received.
✓	✓	✓		✓	C66=500	APPLY	400 .. 699	SIP response yyy is sent if clear-down cause code x is received.
✓	✓	✓		✓	C69=500	APPLY	400 .. 699	SIP response yyy is sent if clear-down cause code x is received.
✓	✓	✓		✓	C70=500	APPLY	400 .. 699	SIP response yyy is sent if clear-down cause code x is received.
✓	✓	✓		✓	C79=501	APPLY	400 .. 699	SIP response yyy is sent if clear-down cause code x is received.
✓	✓	✓		✓	C81=500	APPLY	400 .. 699	SIP response yyy is sent if clear-down cause code x is received.
✓	✓	✓		✓	C82=500	APPLY	400 .. 699	SIP response yyy is sent if clear-down cause code x is received.
✓	✓	✓		✓	C83=500	APPLY	400 .. 699	SIP response yyy is sent if clear-down cause code x is received.
✓	✓	✓		✓	C84=500	APPLY	400 .. 699	SIP response yyy is sent if clear-down cause code x is received.
✓	✓	✓		✓	C85=500	APPLY	400 .. 699	SIP response yyy is sent if clear-down cause code x is received.
✓	✓	✓		✓	C86=500	APPLY	400 .. 699	SIP response yyy is sent if clear-down cause code x is received.
✓	✓	✓		✓	C88=400	APPLY	400 .. 699	SIP response yyy is sent if clear-down cause code x is received.
✓	✓	✓		✓	C91=500	APPLY	400 .. 699	SIP response yyy is sent if clear-down cause code x is received.
✓	✓	✓		✓	C95=400	APPLY	400 .. 699	SIP response yyy is sent if clear-down cause code x is received.
✓	✓	✓		✓	C96=500	APPLY	400 .. 699	SIP response yyy is sent if clear-down cause code x is received.
✓	✓	✓		✓	C97=500	APPLY	400 .. 699	SIP response yyy is sent if clear-down cause code x is received.
✓	✓	✓		✓	C98=500	APPLY	400 .. 699	SIP response yyy is sent if clear-down cause code x is received.
✓	✓	✓		✓	C99=500	APPLY	400 .. 699	SIP response yyy is sent if clear-down cause code x is received.
✓	✓	✓		✓	C100=500	APPLY	400 .. 699	SIP response yyy is sent if clear-down cause code x is received.
✓	✓	✓		✓	C101=500	APPLY	400 .. 699	SIP response yyy is sent if clear-down cause code x is received.
✓	✓	✓		✓	C102=408	APPLY	400 .. 699	SIP response yyy is sent if clear-down cause code x is received.
✓	✓	✓		✓	C111=400	APPLY	400 .. 699	SIP response yyy is sent if clear-down cause code x is received.
✓	✓	✓		✓	C127=500	APPLY	400 .. 699	SIP response yyy is sent if clear-down cause code x is received.

FXS / FXO	BRI	V400	H323	SIP	Section/Parameter	Activate	Range	Comments
					[_advanced.sip.info]			
✓	✓	✓		✓	<a href="#">tx_dtmf=1</a>	APPLY	0 or 1	1: Enable the transmission of DTMF information in INFO messages (when Out Of Band DTMF and DTMF using INFO messages are enabled [dtmf_transport=rfc2833_txinfo or info])
✓	✓	✓		✓	<a href="#">tx_hookflash=1</a>	APPLY	0 or 1	1: Enable the transmission of Hookflash information in INFO messages (when Out Of Band DTMF and DTMF using INFO messages are enabled [dtmf_transport=rfc2833_txinfo or info])
					[_advanced.sip.invite]			
✓	✓	✓		✓	registered=0	APPLY	0 or 1	0: Send INVITE to the configured SIP proxy 1: Only send INVITE to the proxy if the SIP user associated with this call is currently in a registered state - if not registered, return a call clear-down cause code 38. This is used to allow faster re-representation of the calls if registration is lost (e.g. proxy failure)
					[_advanced.sip.loopback_detection]			
✓	✓	✓		✓	sip_header=NULL	APPLY	string 0-31 chars	SIP header to look for, to detect SIP loopback
✓	✓	✓		✓	sip_header_regex=NULL	APPLY	string 0-127 chars	Format of SIP header to look for, to detect SIP loopback
					[_advanced.sip.media]			
✓	✓	✓		✓	T38_use_audio_port=0		0 or 1	0: If set to 0 the Vega will use one IP port number for audio codecs and a different IP port number for T.38 1: If set to 1 the Vega uses the same local IP port number for the duration of the call, whatever re-invites may change codecs, or destination of the call. - Keeping a constant IP port number can help with NAT traversal.
					[_advanced.sip.oli]			PSTN / POTS to SIP
✓	✓	✓		✓	ani_ii_digits=0		0 .. 127	>0: Override / set up ANI Information digit (II) (provides information similar to CPC)
✓	✓	✓		✓	cisco=0		0 or 1	1: Make CPC cisco format.
✓	✓	✓		✓	cpc_value=NULL		Alpha numeric string 1..31 chars	<> NULL: Add calling party category field '<string>' to FROM: field, e.g. '<string>payphone'
					[_advanced.sip.privacy]			See RFC 3326



FXS / FXO	BRI	VA00	H323	SIP	Section/Parameter	Activate	Range	Comments
✓	✓	✓		✓	standard=rfc3323		none, rfc3323 or rpid	<p>none: no privacy information is passed</p> <p>rfc3323: use the Privacy: header in SIP messages as defined in RFC3323 and RFC3325</p> <p>rpid: enable reception of Caller id from the SIP RPID header in received INVITES and the generation of the rpid header in generated INVITES</p>
					[_advanced.sip.q931]			
	✓	✓		✓	tx_tun_mode=off		off, cirpack, req_uri	<p>Mode to use to tunnel ISDN IEs over SIP</p> <p>off: no tunnelling</p> <p>cirpack: tunnelling using a Content_Type: 'application/vnd.cirpack.isdn-ext'</p> <p>req_uri: tunnelling using an X-UUI SIP header</p> <p>See table in section <a href="#">10.5.3 "Tunnelling full signalling messages and IEs in ISDN (ETSI, ATT, DMS, DMS-M1, NI, VN 3/4) and QSIG"</a> for details of interactions of various parameters with tunnel_IEs_only.</p>
					[_advanced.sip.reason]			See RFC 3326
✓	✓	✓		✓	rx_enable=1	APPLY	0 or 1	<p>0: Do not act upon the 'Reason' header in call clearing SIP messages</p> <p>1: Use the Q.850 value received in the 'Reason' header and use it as the call clear-down reason on the telecomms interface</p>
✓	✓	✓		✓	tx_enable=1	APPLY	0 or 1	<p>0: Do not send the 'Reason' header in SIP call clearing messages</p> <p>1: Use the Q.850 value received on the telecomms interface and put it in the reason header of the BYE / CANCEL or INVITE response (e.g. 486 BUSY) message</p>
					[_advanced.sip.redirect]			
✓	✓	✓		✓	preserve_to_header=1		0 or 1	<p>1 - When the Vega receives a 3xx INVITE response, the SIP URI in the To header of the next INVITE (triggered by the 3xx response) is preserved</p> <p>0 - When the Vega receives a 3xx INVITE response, the SIP URI in the To header of the next INVITE (triggered by the 3xx response) is not preserved but is overwritten with the URI in the request URI</p>
					[_advanced.sip.refer]			

FXS / FXO	BRI	VA00	H323	SIP	Section/Parameter	Activate	Range	Comments
✓	✓	✓		✓	refer_to_target=contact	apply	aor, contact or contact_no_ url_params	<p>aor - Refer-To: to use the address of record details, e.g. Refer-To: sip:5001@sip.vegastream.com</p> <p>Contact - Refer-To: to use the contact header details, e.g. Refer-To: 5001@172.19.1.109:5060;urlparaml=w hatever</p> <p>contact_no_url_params - Refer-To: to use the contact header details, but with url parameters stripped e.g. Refer-To: 5001@172.19.1.109:5060</p> <p>Assuming ... SIP/2.0 200 OK To:     &lt;sip:5001@sip.vegastream.com&gt;;tag=     bf166663 From:     "port1"&lt;sip:01@sip.vegastream.com&gt;     ;tag=0031-0006-87614925 Contact:     5001@172.19.1.109:5060;urlparaml=w     whatever</p>
					[_advanced.sip.referred_by]			
✓	✓	✓		✓	enable=1		0 or 1	<p>1 - Enable the referred-by header when implementing a Refer</p> <p>0 - Do not use referred-by header</p>

FXS / FXO	BRI	V400	H323	SIP	Section/Parameter	Activate	Range	Comments
					[_advanced.sip.response_to_cause_mapping]			Note: any cause code received in a SIP 'reason' header will be used in preference to the mapping defined below.
✓	✓	✓		✓	R4xx=21		1 .. 127	Cleardown cause x is sent if SIP response yyy is received.
✓	✓	✓		✓	R5xx=41		1 .. 127	Cleardown cause x is sent if SIP response yyy is received.
✓	✓	✓		✓	R6xx=21		1 .. 127	Cleardown cause x is sent if SIP response yyy is received.
✓	✓	✓		✓	R400=127		1 .. 127	Cleardown cause x is sent if SIP response yyy is received.
✓	✓	✓		✓	R401=57		1 .. 127	Cleardown cause x is sent if SIP response yyy is received.
✓	✓	✓		✓	R402=21		1 .. 127	Cleardown cause x is sent if SIP response yyy is received.
✓	✓	✓		✓	R403=57		1 .. 127	Cleardown cause x is sent if SIP response yyy is received.
✓	✓	✓		✓	R404=1		1 .. 127	Cleardown cause x is sent if SIP response yyy is received.
✓	✓	✓		✓	R405=127		1 .. 127	Cleardown cause x is sent if SIP response yyy is received.
✓	✓	✓		✓	R406=127		1 .. 127	Cleardown cause x is sent if SIP response yyy is received.
✓	✓	✓		✓	R407=21		1 .. 127	Cleardown cause x is sent if SIP response yyy is received.
✓	✓	✓		✓	R408=102		1 .. 127	Cleardown cause x is sent if SIP response yyy is received.
✓	✓	✓		✓	R409=41		1 .. 127	Cleardown cause x is sent if SIP response yyy is received.
✓	✓	✓		✓	R410=1		1 .. 127	Cleardown cause x is sent if SIP response yyy is received.
✓	✓	✓		✓	R411=127		1 .. 127	Cleardown cause x is sent if SIP response yyy is received.
✓	✓	✓		✓	R413=127		1 .. 127	Cleardown cause x is sent if SIP response yyy is received.
✓	✓	✓		✓	R414=127		1 .. 127	Cleardown cause x is sent if SIP response yyy is received.
✓	✓	✓		✓	R415=79		1 .. 127	Cleardown cause x is sent if SIP response yyy is received.
✓	✓	✓		✓	R416=21		1 .. 127	Cleardown cause x is sent if SIP response yyy is received.
✓	✓	✓		✓	R420=127		1 .. 127	Cleardown cause x is sent if SIP response yyy is received.
✓	✓	✓		✓	R422=21		1 .. 127	Cleardown cause x is sent if SIP response yyy is received.
✓	✓	✓		✓	R480=18		1 .. 127	Cleardown cause x is sent if SIP response yyy is received.
✓	✓	✓		✓	R481=127		1 .. 127	Cleardown cause x is sent if SIP response yyy is received.
✓	✓	✓		✓	R482=127		1 .. 127	Cleardown cause x is sent if SIP response yyy is received.

FXS / FXO	BRI	V400	H323	SIP	Section/Parameter	Activate	Range	Comments
✓	✓	✓		✓	R483=127		1 .. 127	Cleardown cause x is sent if SIP response yyy is received.
✓	✓	✓		✓	R484=28		1 .. 127	Cleardown cause x is sent if SIP response yyy is received.
✓	✓	✓		✓	R485=1		1 .. 127	Cleardown cause x is sent if SIP response yyy is received.
✓	✓	✓		✓	R486=17		1 .. 127	Cleardown cause x is sent if SIP response yyy is received.
✓	✓	✓		✓	R487=127		1 .. 127	Cleardown cause x is sent if SIP response yyy is received.
✓	✓	✓		✓	R488=88		1 .. 127	Cleardown cause x is sent if SIP response yyy is received.
✓	✓	✓		✓	R491=21		1 .. 127	Cleardown cause x is sent if SIP response yyy is received.
✓	✓	✓		✓	R500=41		1 .. 127	Cleardown cause x is sent if SIP response yyy is received.
✓	✓	✓		✓	R501=79		1 .. 127	Cleardown cause x is sent if SIP response yyy is received.
✓	✓	✓		✓	R502=38		1 .. 127	Cleardown cause x is sent if SIP response yyy is received.
✓	✓	✓		✓	R503=63		1 .. 127	Cleardown cause x is sent if SIP response yyy is received.
✓	✓	✓		✓	R504=102		1 .. 127	Cleardown cause x is sent if SIP response yyy is received.
✓	✓	✓		✓	R505=127		1 .. 127	Cleardown cause x is sent if SIP response yyy is received.
✓	✓	✓		✓	R580=47		1 .. 127	Cleardown cause x is sent if SIP response yyy is received.
✓	✓	✓		✓	R600=127		1 .. 127	Cleardown cause x is sent if SIP response yyy is received.
✓	✓	✓		✓	R603=21		1 .. 127	Cleardown cause x is sent if SIP response yyy is received.
✓	✓	✓		✓	R604=1		1 .. 127	Cleardown cause x is sent if SIP response yyy is received.
✓	✓	✓		✓	R606=88		1 .. 127	Cleardown cause x is sent if SIP response yyy is received.
					<b>[_advanced.sip.rport]</b>			
✓	✓	✓		✓	enable=1	APPLY	0 or 1	If enabled include the rport parameter in SIP messages.
✓	✓	✓		✓	<b>[_advanced.sip.sdp]</b>			
✓	✓	✓		✓	annexb_param=1		0 or 1	If set to 1 then the G.729 annexb field is included in the SDP of a sip invite, e.g. a=fmtp:18 annexb=no or a=fmtp:18 annexb=no (G.729 annex b is VADU / silence suppression for G.729)
✓	✓	✓		✓	clear_channel_mode=rfc4040		rfc4040 or octet-	When the 'octet' or clear mode codec is negotiated this parameter defines the

FXS / FXO	BRI	VA400	H323	SIP	Section/Parameter	Activate	Range	Comments
							stream	way the data stream should be encoded. (RFC4040 is a standard and uses RTP/AVP id 97, octet-stream is VegaStream proprietary - available for backward compatibility)

FXS / FXO	BRI	VA00	H323	SIP	Section/Parameter	Activate	Range	Comments
✓	✓	✓		✓	codec_selection=remote		local or remote	local: Vega will use its own codec priority order when negotiating the codec to use  remote: Vega will use the requested codec priority order when negotiating the codec to use
✓	✓	✓		✓	<a href="#">direction_attribute</a> =on		off or on	off: a=<direction> is not generated by the Vega and reception of it is ignored  on: Enable handling of the a=<direction> attribute
✓	✓	✓		✓	fqdn=1		0 or 1	0: use a dotted decimal IP address in the "c=" (connection information) and "o=" (owner/creator and session identifier) lines in the SDP.  1: use a FQDN (Fully Qualified Domain Name) in the "c=" (connection information) and "o=" (owner/creator and session identifier) lines in the SDP (providing lan.name resolves to lan.if.x.ipname)
✓	✓	✓		✓	<a href="#">maxptime_enable</a> =0		0 or 1	1: requests the a=maxptime attribute to be included in the SIP sdp
✓	✓	✓		✓	nat_enable=1		0 or 1	For engineering use only, do not change.
✓	✓	✓		✓	<a href="#">ptime_mode</a> =0	APPLY	0 or 1, mptime, x_mptime, ptime30, ptime60	0: Vega ignores all ptime (packet time) requests in SDPs and does not generate any  1: Vega handles ptime (packet time) requests made in incoming INVITE SDPs and responds with ptime in outgoing RINGING SDPs, it also generates ptimes in outgoing INVITES  mptime: Multiple packet time; allows specification of packet times for each offered codec  x_mptime: as mptime, just uses a different keyword X-mptime  ptime30: as 1, but uses 30ms value, unless all codecs are G.711, when it will use a 20ms value.  ptime60: as 1, but uses 60ms value if all offered codecs are capable of supporting 60ms, and unless all codecs are G.711. If all codecs are G.711, then it will use a 20ms value, and if not all codecs are G.711, but 60ms is not supported by all codecs then 30ms will be used.
✓	✓	✓		✓	<a href="#">sess_desc_connection</a> =1	APPLY	0 or 1	0: SIP "c=" header is part of SDP media description  1: SIP "c=" header is part of SDP session description
✓	✓	✓		✓	t38_single_media=1	APPLY	0 or 1	0: For T.38 request multiple SIP "m=" headers are included in the request - includes audio as well as image lines  1: For T.38 request only a single SIP "m=" header is included in the request

FXS / FXO	BRI	VA00	H323	SIP	Section/Parameter	Activate	Range	Comments
								- just the image line
					[_advanced.sip.sdp.answer]			
✓	✓	✓		✓	zero_ip_on_hold=0	APPLY	0 or 1	0: Vega will supply its local IP address in the SDP answer when the remote endpoint initiates a call hold. 1: Vega will will supply an IP address of 0.0.0.0 in the SDP answer when the remote endpoint initiates a call hold.
					[_advanced.sip.sdp.offer]			
✓	✓	✓		✓	zero_ip_on_hold=0	APPLY	0 or 1	0: Vega will supply its local IP address in the SDP offer (in the re-INVITE) when it initiates a call hold. 1: Vega will will supply an IP address of 0.0.0.0 in the SDP offer (in the re-INVITE) when it initiates a call hold.
					[_advanced.sip.sdp.t38params]			
✓	✓	✓		✓	max_buffer=1	S/R	0 or 1	Include max buffer information in T.38 messages
✓	✓	✓		✓	max_datagram=1	S/R	0 or 1	Include max datagram information in T.38 messages
					[_advanced.sip.simple_suppress]			
	✓	✓		✓	enable=0	S/R	0 or 1	If enabled the Vega will generate a call transfer request on reception of a DTMF #
					[_advanced.sip.tcp]			
✓	✓	✓		✓	cleanup_old_sockets=0	S/R	0..120	0: release sockets as they are believed to be finished with 1..120: only clear up sockets if the far end close the socket, or all sockets are used up. If all sockets are used up, this value specifies how many sockets to free up at a time. (For engineering use only, do not change)
✓	✓	✓		✓	enable=1	S/R	0 or 1	0: Disable SIP TCP functionality (For engineering use only, do not change) 1: TCP SIP functionality available
					[_advanced.sipproxy]			See also 'IN_41-Vega Resilience Proxy' on <a href="http://www.VegaAssist.com">www.VegaAssist.com</a>
					crlf_keepalive=0		0..180	Time in seconds to send <CR> <LF> to keep alive a TCP link
					itsp_down_reg_expires=60		30..60000	Registration expires time to use if ITSP is down - the shorter the time the sooner calls will return to using the ITSP proxy when the ITSP proxy recovers.

FXS / FXO	BRI	V400	H323	SIP	Section/Parameter	Activate	Range	Comments
					reg_forwarding_timeout=10		2..60	
					num_sockets=120		60..240	Number of sockets to allow
					record_route=always		always or call_setup	
					server_header=1		0 or 1	
					<b>[_advanced.t38]</b>			
					allow_MR_page_compress=1		0 or 1	0 = suppress use of MR Page compression on fax traffic 1 = If fax machines try to use MR Page compression, Vega will pass it through
					allow_ecm=1		0 or 1	0 = suppress use of Error Correction Mode on fax traffic 1 = If fax machines try to use ECM, Vega will pass it through
					enable_Eflags_in_first_DIS=1		0 or 1	Controls parameter in first T30 DIS message - for engineering use only, do not change
					enable_TFoP=1		0 or 1	0 = disable repetition of FrameComplete packet 1 = repeat FrameComplete packet over the packet network for improved performance
					enable_scan_line_fix_up=1		0 or 1	0 = disable scan line fix-up 1 = fill in gaps in the received T.38 data to allow as much information as possible to be printed
					<b>[_advanced.t38.tcp]</b>			T.38 TCP mode parameters
✓	✓	✓	✓		collect_hdlc=0	CALL	0 or 1	1 = Collect fragmented V.21 HDLC packets (generated by the DSP) into a single TPKT before transmission over TCP
✓	✓	✓	✓		connect_on_demand=1	S/R	0 or 1	0 = try to open a T.38 TCP socket at the start of every call 1 = only try to open a T.38 TCP sockets if fax tones are detected
✓	✓	✓	✓		port_range_list=2		0 or 1	Index into _advanced.lan.port_range_list.x to specify which list of port ranges specifies the ones to use for TCP T.38 ... not needed for SIP as SIP only supports UDP T.38
✓	✓	✓	✓		suppress_t30=0	CALL	0 or 1	1 = suppress transmission of the "T.30: no-signal" and the "T.30: V.21-preamble"



FXS / FXO	BRI	VA400	H323	SIP	Section/Parameter	Activate	Range	Comments
					[_advanced.t38.udp]			T.38 TCP mode parameters
✓	✓	✓	✓		check_start_packet=1		0 or 1	0: switch to fax mode immediately, whether fax packet is received, or further RTP audio 1: only switch to fax mode when first fax packet received
✓	✓	✓	✓	✓	port_range_list=3		1 .. 100	Index into _advanced.lan.port_range_list.x to specify which list of port ranges specifies the ones to use for UDP T.38

## 6.9 Exporting / Importing Configuration Data

To export and import configuration data to/from an FTP or a TFTP server use the `PUT` and `GET` commands. These can be run from the CLI prompt or the `advanced>CLI` Command section of the web browser.

```
PUT file_path section    writes the configuration parameters in section of the user
                        config memory to the FTP or TFTP server as named file
                        file_path

GET file_path           reads the file file_path from the FTP or TFTP server into user
                        config memory
```

NOTE
------

- 1) Use `GET` with caution; `GET` overwrites parameters
- 2) This is very useful for archiving configuration parameters for re-load after an upgrade and to create template configuration files – allowing multiple Vegas to be configured with similar configurations
- 3) For more details on `PUT` and `GET`, see section [5.5 "TFTP and FTP"](#)

The file generated by the `PUT` or `TPUT` operation is in the form of a script file, using the `CP` and `SET` commands. When this script is echoed back to the CLI (using `GET` or by reading in via a terminal) it will recreate the appropriate configuration structures. Comment lines start with a `;` character and are ignored when the script is read back in.

The file can be edited on the server to change any entries specific to the individual gateway (eg. `lan.if.x.ip`).

```
;
; Script generated using
; PUT test6.txt lan.
; Vega50WISC:01/01/1999 00:00:23
;
set .lan.dns=0.0.0.0
set .lan.gateway=0.0.0.0
set .lan.ip=172.16.30.130
set .lan.name=Vega50WISC
set .lan.ntp=0.0.0.0
set .lan.ntp_local_offset=0000
set .lan.ntp_poll_interval=0
set .lan.subnet=255.255.248.0
set .lan.tftp=172.16.30.8
set .lan.use_dhcp=1
cp .
;
; PUT end
;
```

## 7 USER ADMINISTRATION

### 7.1 Default Users

The User Administration facility allows username/password login to the Vega products. The web browser allows access by the admin user only, telnet and serial interfaces allow access by the three users, admin, billing, and user. Each username (admin, billing and user) grants a particular level of access to the system.

#### Admin

Full access privileges; can modify anything.

Default state for logging:- system: ALL levels, billing: OFF

Can modify any password

Can access UPGRADE menu

Can action privileged commands

Initial password = 'admin'

Any admin user logged in is informed of other administrator actions in the following situations:

When any user with 'admin' privileges logs in.

When a user with 'admin' privileges makes a change to a password.

#### Billing

Cannot modify database; can only view it

Default state for logging:- system: OFF, billing: ON

Cannot access UPGRADE menu

Cannot action privileged commands

Can execute commands `bill display on/off/z`

Initial password = 'billing'

#### User

Cannot modify database; can only view it

Default state for logging:- system: ALERT, billing: OFF

No access allowed for billing

Cannot access UPGRADE menu

Cannot action privileged commands

Initial password = 'user'

Passwords can only be changed by an admin user using the PASSWORD command. Stored passwords are encrypted and immune from the FACTORY RESET operation.



**WARNING!**

***If the admin password is lost or forgotten the only way to restore the system is to perform a BOOT menu erase operation to erase all the system configuration. This can only be performed via the serial interface and will destroy all saved data in the Vega (including, for example, lan.if.1.ip).***

### 7.1.1 User Configuration

Customisation of each user type can be accomplished using the following parameters:

```
[users.admin], [users.billing] or [users.user]
remote_access=0/1
timeout=0-1000
logging=0-5
billing=0-5
prompt=...
```

The `remote_access` parameter controls whether telnet and WWW access is allowable for this user.

Timeout is an inactivity timer used to automatically log a user out of the interface if no commands are typed within the specified period. The inactivity timeout period is specified in seconds from 1 to 7200; a value of zero has a special meaning "disable user inactivity timeouts".



**WARNING!**

***If timeout is set to 0, although telnet sessions close down when exited, web browser sessions ONLY close down if exited using the "Log Off" button – sessions will be left hanging if the window close button is used, and they can only be cleared by rebooting the Vega, or explicitly using the `kill` command.***

The `logging` and `billing` parameters control the default state of "log" and "bill" at login:

For logging,

```
0=no logging,
1=all messages logged,
2=Alert and above messages logged,
3=Warning and above messages logged,
4=Failure and above messages logged,
5=Error and above messages logged,
6=X_fatal messages logged.
```

For billing,

```
0=bill display off,
1=bill display on at logon time
```

Prompt defines the format of the CLI prompt. The definition can consist of characters and any of the following tokens:

```
%n = host name
%i = host ip address (Lan 1)
%t = local time
%p = configuration path
%u = user name
```

NOTE
------

1. These [users] parameters are not used by the Vega until the next login.
2. Telnet access for the BILLING user is prevented until the billing user password has been changed from its default value.

## 7.2 Configurable Users

The username and permissions levels of gateway users can now be configured. New users can be created with definable usernames, and one of four permissions levels can be configured:

- "admin"
  - Full permissions for access to all parameters and commands
- "privacy". No access to the following:
  - show trace
  - sip monitor on
  - any bill command - "bill display on", "show bill", etc
  - any log command - "log display on", "show log", etc
  - any debug command - "debug enable", "debug on", etc
  - setting of certain configuration variables (see "privileged config variables" section above)
  - show support output is restricted to permitted commands
  - can only change password for themselves (not for any user)
  - "qos report on", "show qos cdr" and "show qos cdr last" will not show any Route information.
- none
  - User can login, but is not able to issue any commands (used when user has not been fully configured)
- provision
  - SIP passwords are hidden in put / sput output

This change applies to web browser, telnet, ssh and console access.

To set the password of a new user the "password" command can be used.

### Configuration

Parameter:

```
users.x.privileges
```

Possible values:

```
none - Default - User has no permissions
```

```
admin - Full access
```

```
privacy - User has reduced access as per list above
```

```
provision - User has reduced access as per list above
```

Parameter:

```
users.x.timeout
```

Possible values:

1800 - Time in seconds after which user will be logged out. Default 1800

Parameter:

users.x.username

Possible values:

String between 1 and 63 characters in length

## 7.3 Changing User Passwords

Users passwords can be changed by the administrator (admin) using the PASSWORD command:

```
admin >password
Enter user details
Username : admin
New password      : ****
Confirm password : ****
Password change successful
LOG: 01/01/1999 00:00:31 TELNET (A)Rb9C01 password changed for user 'admin'
admin >
```

## 7.4 RADIUS Login Authentication

The Vega can optionally be configured to use a RADIUS server to authenticate users when logging in. On logging in the Vega sends the username and password to the configured radius server for verification rather than holding the password locally. The permissions for the user will be held locally on the Vega.

There is a 2 second timeout for the radius login. If the Vega doesn't receive a radius server response in 2 seconds, the login will fail.

A new CLI command has also been added that allows the configured radius server to be tested. Radius based login should be thoroughly tested before using. Failure to test may result in permanent lock out from the Vega.

### 7.4.1 Configuration

Parameter added:

users.radius\_login

Possible values:

0 - Default - Do not use radius based authentication  
1 - Use radius authentication

Parameter added:

logger.radius.server.1.auth\_port

Possible values:

1 to 65535 - Port to use for radius authentication - Default 1813

## 7.4.2 Test Command

A new command has been added to the Vega – `radius login test` – to check operation of the configured radius server and users. This command causes a radius message to be sent to the configured radius server containing the credentials entered.

### Example

Assume a user has been setup with username of "admin" and correct password of "callme123". Issue the `radius login test` command with the correct credentials:

```
admin >radius login test admin callme123
RADIUS username and password ok.
```

Vega confirms configuration is correct.

Now issue the `radius login test` command with incorrect credentials (wrong password):

```
admin >radius login test admin callme124
RADIUS login test failed.
```

Vega indicates that login would have failed. The same message would be received if the radius server was incorrectly configured.



**WARNING!**

**Do not enable radius login until the radius server has been configured and tested using the above command. If radius login is enabled but not correctly configured, the Vega will become inaccessible.**

## 7.5 Logged on users

Information concerning which users are logged in can be obtained from the "Connections active" section in the output from the "SHOW PORTS" command.

e.g. for a with 4 ISDN BRI interfaces:

```
admin >show ports
```

Physical ports:

Name	Type	Status	
ISDN-1	WAN	link-down	(TE ) [X..]
ISDN-2	WAN	link-down	(NT ) [X..]
ISDN-3	WAN	link-up	(TE*) [X..]
ISDN-4	WAN	link-up	(NT ) [X..]
SIP -1	LAN	100Mbit Half Duplex	
SIP -2	LAN	link-down	

DSL settings:

BRI 1:	Top=BRI	Net=ETSI	Line=AZI	Frm=S/T	lyr1=g711Alaw64k
BRI 2:	Top=BRI	Net=ETSI	Line=AZI	Frm=S/T	lyr1=g711Alaw64k
BRI 3:	Top=BRI	Net=ETSI	Line=AZI	Frm=S/T	lyr1=g711Alaw64k
BRI 4:	Top=BRI	Net=ETSI	Line=AZI	Frm=S/T	lyr1=g711Alaw64k

DSL statistics:

Port	Frames	TX			RX			
		Bytes	SLIPs	Frames	Bytes	SLIPs	CRC Error	Bad
BRI-1	0	0	--	0	0	0	0	0
BRI-2	0	0	--	12	36	0	0	0
BRI-3	271	1082	--	271	1082	0	0	0
BRI-4	271	1082	--	271	1082	0	0	0

Physical interfaces:

device		RJ45 Connectors	RJ21 Connector
ISDN port	1 (BRI)	RJ45 port 1	N/A
ISDN port	2 (BRI)	RJ45 port 2	N/A
ISDN port	3 (BRI)	RJ45 port 3	N/A
ISDN port	4 (BRI)	RJ45 port 4	N/A

System Fan: Normal  
System Temperature: Normal

Connections active:

ID	Port	Address	User	Connection start time
1	RS-232		admin	01/01/1999 00:19:42
2	Telnet	192.168.1.108	admin	01/01/1999 00:22:04



```
10* WWW 172.19.1.68 admin 18/01/2006 15:45:49
vega5002 has been running for 0 days, 00:50:41 hh:mm:ss
```

```
Statistics Cleared: Never
```

The "Connections active" section shows all the logged on users, including their login level (admin, billing or user) and for WWW and Telnet sessions the IP address of the terminal accessing the Vega. If there is a logged on session that should not be, the session can be killed by typing:

```
Kill <ID>
```

Where <ID> is the ID value from the ID column in the "Connections active" section.

**NOTE**

Kill will not allow you to kill your own login session (indicated in the connections section by a \* against the ID)

## 8 THE DIAL PLANNER

The dial planner is the engine that processes incoming call requests. It provides three basic functions:

- A. Routing
- B. Number translation
- C. Authentication

**Routing:** Based on the incoming information presented to the Vega (e.g. telephone number, Caller ID, incoming interface ID) the Vega can decide which interface and if appropriate what IP address to route the call to.

**Number translation:** The Vega can manipulate the telephone number received by adding prefixes / postfixes, inserting digits, modifying the order of received digits and using digits from other fields (like the Interface ID or the Caller ID) to create the new telephone number that is to be presented on the outbound leg of the call.

**Authentication:** When a call arrives the Vega looks for dial plans that match the received information. If no dial plan exists then the call will not be accepted. Only calls which have dial plans that match the incoming information will be onward routed.

Dial plans are a set of rules which say "if the information from the incoming call matches this dial plan's source tokens, then use this dial plan's destination tokens to onward route the call"

In the case of interworking with an H.323 gatekeeper or a SIP proxy, the dial planner will typically be configured with minimal information; the Routing, Number Translation and Authentication will be carried out by gatekeeper or the SIP proxy. In these cases:

- for calls from telephony to LAN the dial planner can be used to augment the caller information with for example an indicator of which gateway the call arrived on, or perhaps re-format the caller information in a standard way for the gatekeeper / proxy if the incoming data is provided in different formats on different gateways.
- for calls from LAN to telephony the call is presented to the dial planner after the gatekeeper / proxy has carried out its processing – in this way the Vega will typically just need to pass the call through, but may manipulate information to ensure that the call is presented to the correct telephony port and if required manipulate dial digit strings to format them for use on this specific telephony interface (if the gatekeeper has not already done this).

***For a 'presentation style' description on how to write dial plans please see Information Note 'IN\_20-Introduction to Vega Dial Plans'.***

## 8.1 Interfaces

Each interface or interface group within the gateway that is capable of generating and / or receiving calls is assigned an interface ID value. The interface ID is a string of up to 32 characters defined in a parameter within the relevant interface's configuration section. By default the following interfaces are defined on the Vega product range:

Product	Interface	Default Interface IDs	System Configuration Entry	Interface Type
Vega 400	E1 / T1	0401 .. 0404	e1t1/bri.port.n.group.m.interface	Telecomm
Vega 50 Europa	FXS / FXO / BRI	FXS: 0101 .. 0108 FXO: 0201 .. 0208 BRI: 0301 .. 0308	pots.port.n.if.m.interface pots.port.n.if.m.interface e1t1/bri.port.n.group.m.interface	Telecomm
Vega 5000	FXS / FXO	FXS: 0101 .. 0148 FXO: 0201 .. 0202	pots.port.n.if.m.interface pots.port.n.if.m.interface	Telecomm
All H.323	H.323	0501	h323.interface	VoIP
All SIP	SIP	9901, 9902, ... 9905	sip.interface	VoIP

The dial planner uses interface IDs to specify the interface for both incoming and outgoing calls.

**NOTE**

Although interface IDs can be changed, to make supporting the product easier it is recommended that these values are NOT changed.



H.323  
ID

## 8.2 Dial Plan Tokens

Each incoming (source) and outgoing (destination) dial plan definition consists of a number of elements called *tokens*. Each token identifies a different attribute of the call address, and tokens are separated by a comma. The available tokens are:

IF:<up to 32 characters of: 0 to 9, a to z, #, *, underscore, dot >	e.g. IF:0101	Specify interface ID for incoming A-party or outgoing B-party (see below)
TEL:<0 to 9, a to z, #, *, underscore, dot>	e.g. TEL:123	Specify incoming or outgoing B-party (called party) telephone number in E.164 (numeric) or textual form
TELC:<e164-number>	e.g. TELC:123	Specify the incoming or outgoing A-party (calling party) telephone number (Caller ID) in E.164 (numeric) format
TA:<ip address>	e.g. TA:200.100.50.40	Specify outgoing B-party (called party) IP address or host name (Transport Address)
TAC:<ip address>	e.g. TAC:200.100.50.40	Specify incoming A-party (calling party) IP address or host name (Transport Address of the Calling party)
DISP:<ascii-string>	e.g. DISP:John	Specify incoming or outgoing H.323, SIP or ISDN setup message display field
NAME:<ascii-string>	e.g. NAME:vega400	Specify incoming or outgoing B-party (called party) H.323 ID
NAMEC:<ascii-string>	e.g. NAMEC:vega400	Specify the outgoing A-party (calling party) H.323 ID
TYPE:	TYPE:national	Specify the outgoing Type Of Number field for the called party number
TYPEC:	TYPEC:national	Specify the outgoing Type of Number field for the calling party number
PLAN:	PLAN:national	Specify the outgoing Number Plan Information field for the called party number
PLANC:	PLANC:national	Specify the outgoing Number Plan Information field for the calling party number
SCRNC:	SCRNC:not_screened	Specify the outgoing Screening Indicator field for the calling party number
PRESC:	PRESC:allowed	Specify the outgoing Presentation Indicator field for the calling party number

There are two further tokens that can be used in destination dial plan entries:

CAPDESC:<capdesc-ID>	e.g. CAPDESC:02	Specify which subset of codecs (CapDesc set) to offer for calls made to the LAN using this dial plan, i.e. only used where the destination dial plan entry has an IF:05, or IF:99
QOS:<QOS profile>	e.g. QOS:03	Specify the Quality Of Service profile to use for calls made to the LAN using this dial plan.

NOTE

Token names must be all capitals followed by a colon, e.g.  
TEL:

## Examples:

Incoming address from a softphone: `IF:0501,NAMEC:chris,TEL:12345`

*(These tokens specify a call arriving on the H.323 interface, interface 0501, from a caller "chris"; who has dialled the number "12345").*

Outgoing address to a destination (SIP) gateway: `IF:9901,TA:200.100.50.18,TEL:123`

*(These tokens specify a call being sent to IP address 200.100.50.18 via the SIP interface, interface 99, presenting a telephone number "123").*

Outgoing call via a gatekeeper, or `h323.if.x.default_ip`: `IF:0501,NAME:chris_456`

*(These tokens specify a call being sent to the H.323 interface, interface 0501 (no IP address is needed here if the call is gatekeeper routed – the gatekeeper will supply the IP address – or if there is a default\_ip configured) to an endpoint whose NAME is "chris\_456").*

Incoming address from ISDN: `IF:0401,TEL:5551000`

*(These tokens specify a call arriving on the first ISDN interface, interface 0401, where a telephone number "5551000" was dialled).*

The IF: (interface) token is mandatory for destination statements. Also, specifying a TA: token is required for destinations which are on the LAN, unless a gatekeeper or proxy is configured which will supply the IP address, or for H.323 systems where the parameter `h323.if.x.default_ip` has been configured (`default_ip`) provides an implicit TA: for destination LAN dial plan entries if no TA: is explicitly defined – however good practice recommends that TA:s are defined explicitly in the dial plans as it makes it easier for others to see exactly how the dial plan is designed to route the call).

All other tokens are optional and can be specified in any order.

The table and diagrams below define where the various tokens can be used.

	H.323 LAN (0501)		SIP LAN (9901)		Telephony	
	Source	Destination	Source	Destination	Source	Destination
IF:	✓	✓ Mandatory	✓	✓ Mandatory	✓	✓ Mandatory
TEL:	✓	✓	✓	✓	✓	✓
TELC:	✓	Passed through ✓	✓	Passed through ✓	✓	Passed through ✓
TA:		✓		✓		
TAC:	✓		✓			
DISP:	✓	✓	✓	✓		✓ ISDN only
NAME:	✓	✓	✓			
NAMEC:		✓				
TYPE:		✓				✓
TYPEC:		✓				✓
PLAN:		✓				✓
PLANC:		✓				✓
SCRNC:		✓				✓
PRESC:		✓				✓
CAPDESC:		✓		✓		
QOS:		✓		✓		

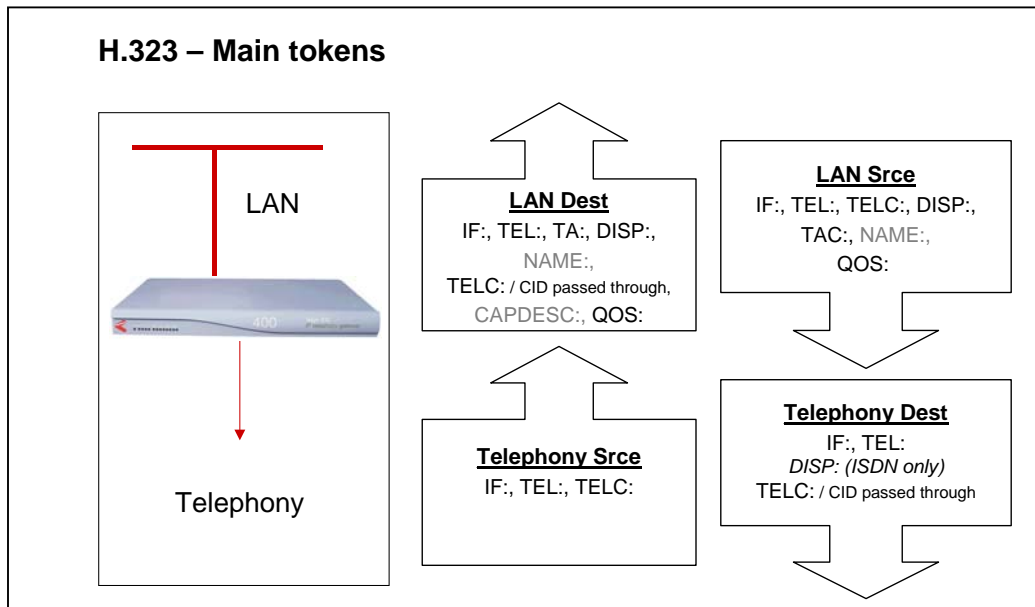

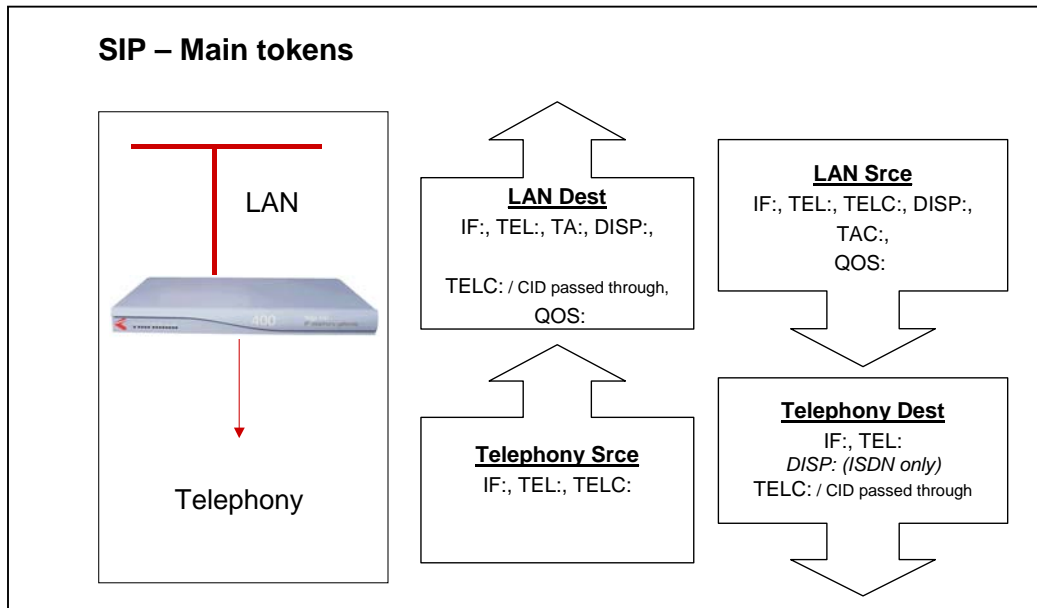

**NOTE**

On a SIP Vega, if TA: is configured in the dial planner dest statement, and, if a call is placed and that SIP proxy / endpoint is down (does not respond with a TRYING, RINGING or OK in the appropriate timeframe), the Vega will try and use sip proxy 2, 3, ... (if any are configured) to route the call. For details on configuring multiple proxies, see section [15.4.2.1 "Multiple SIP Proxy Support"](#)

## 8.3 Dial Planner Structure

The dial planner structure comprises a series of numbered profiles, and within each is a set of individual plan entries. The structure within the system configuration databases is as follows:

```
[planner.profile.1]
  name=<profile 1 name>
  enable=1

[planner.profile.1.plan.1]
  name=<profile 1's plan 1 name>
  cost=x
  srce=<source expression>
  dest=<destination expression>
  group=<group number>

[planner.profile.1.plan.2]
  name=<description>
  ... etc.

[planner.profile.2]
  name=<profile 2 name>
  enable=1

[planner.profile.2.plan.1]
  name=<profile 2's plan 1 name>
  ... etc.

... etc.
```

The idea is that each profile represents a set of plans relating to a particular area or sub-system. Each profile can be enabled or disabled individually; enabling a profile makes all plans within that profile active, disabling the profile makes all plans within that profile in-active. Any number of profiles (up to the maximum number of profiles) may be active at one time.

### 8.3.1 Show Plan

Dial plan details can be displayed either in raw stored form – from the user configuration memory – using `SHOW PLANNER.PROFILE`; or alternatively they can be displayed from the runtime configuration memory using `SHOW PLAN`. When using `SHOW PLAN` the dial plan information is syntax checked and processed to indicate exactly how the Vega will act upon the dial plan information. If there are any syntax errors that will prevent the Vega using dial plan entries these will be indicated.

Example `SHOW PLAN` – 3 plans in a single profile:

```
admin > show plan
```

```
Interfaces:
```

Interface	Name	Port	Group	Channels	Type
0101	POTS	1	1	2	POTS
0102	POTS	2	1	2	POTS
0103	POTS	3	1	2	POTS
0104	POTS	4	1	2	POTS
0105	POTS	5	1	2	POTS
0106	POTS	6	1	2	POTS
0107	POTS	7	1	2	POTS
0108	POTS	8	1	2	POTS
0501	H323	1	1	-	LAN

```
H323 operating mode: NO GATEKEEPER, default gateway: 195.44.197.202
```



Profile 1: Vega50\_default (enabled)

Index	Grp	Source	Destination
/Cost		Int'face Address	Int'face Address
1/0	0	0101 TEL:<.*>	0501 TEL:<1>
2/0	0	0102 TEL:<.*59>	0501 TEL:<1>
3/0	0	0501 TEL:<.*>	0102 TEL:<1>

The above shows the nine interfaces on an H.323 Vega FXS, followed by a single profile of three plans.

To see the dial plan entries presented in priority order per port, see “Show Paths” in section [8.5.3 “Show Paths Command”](#)

### 8.3.2 Adding Plan Entries

Each plan entry consists of four pieces of information: the source expression, the destination expression, the group, and the cost index. When a call arrives at one of the interfaces the dial planner searches all plans within profiles that are enabled in order of longest match (see below) for a matching source expression to the incoming called party number and interface (and other source tokens). Once one is found then it uses the corresponding destination expression to create an ongoing called party number and interface to be dialed.

To create a new dial plan entry, on the web interface select the dial plan  button under the specific profile from the dial plan page. On a CLI interface type `new plan` from the desired profile, e.g.:

```
admin > profile 1
admin planner.profile.1> new plan
admin planner.profile.1.plan.4> show
[planner.profile.1.plan.4]
  cost=0
  dest=IF:<1>,TEL:<2>
  group=0
  name=new_plan
  srce=TEL:<...><.*>
admin planner.profile.1.plan.4> set srce=<srce tokens> dest=<dest tokens>
```

To configure the dial plan parameters overwrite the default values (provided by the Vega) with the new required values.

### 8.3.3 Moving to a specific Dial Plan entry

To get to a specific dial plan entry, on the web interface click the “Modify” button against the appropriate profile, then click the “Modify” button against the desired dial plan entry.

On a CLI interface use change path (CP) with the full path of the dial plan entry required. E.g.:

```
cp .planner.profile.2.plan.6
```

Alternatively, as a short cut use:

```
profile n
```

as a short form for writing

```
cp .planner.n
```

and use

```
plan m
```

as a short form for typing

```
cp plan.m
```

`plan m` works from any path that already has a `planner.n` set up, it will replace anything after the `planner.n` with `plan.m`

### 8.3.4 Creating a Source Expression

The source expression consists any combination of the above tokens. If the interface token is not supplied then the expression `IF:.*` for 'any interface' is assumed. Regular expressions (wildcards) can be used to specify multiple patterns for the each source address ([see below](#)), e.g.

```
set srce=IF:0401,TEL:123
```

matches an incoming call on interface 01 (E1T1 1) calling the number 123

```
set srce=TEL:123.*
```

matches an incoming call on any interface (LAN or telephony) calling a number starting with 123

**NOTE**

`TOKEN:value` expressions are separated by a comma – there must not be any space characters in the `srce` expression.

### 8.3.5 Creating a Destination Expression

The destination expression consists of the `IF:` token (mandatory) and any combination of `TEL:`, `TELC:`, `DISP:`, `TA`, `CAPDESC:` and for H.323 `NAME:` tokens, e.g.

```
set dest=IF:0501,TA:200.100.50.45,TEL:123,NAME:harry
```

Portions extracted from the matched source address can be substituted into the destination address to form a composite address; for this special tokens are used ([see below](#)).

**NOTE**

`TOKEN:value` expressions are separated by a comma – there must not be any space characters in the `dest` expression.

### 8.3.6 Regular Expressions

Regular Expressions (RE's) can be used in **source** expressions to specify patterns which match more than one possible number/address using special wildcard symbols. The wild card symbols available are as follows:

.	any character
[abc]	any character within the parentheses
[x-y]	any character in the range x-y
[^abc]	any character except those within the parentheses
*	the character/expression before repeated zero or more times
+	the character/expression before repeated one or more times
?	the character/expression before repeated zero or one times
\	literalise the following character (e.g. \* = * and not a repeat of the previous character)
<n>	capture the sequence in parentheses and store as <n> where n is the nth occurrence of <n> in the source expression

NOTE
------

These Regular Expressions / Wildcards must **only** be used in source expressions. Destination expressions must define the tokens absolutely.

For the destination expressions there are some Meta Characters available:

~	pause (a DTMF tone delay, e.g. used for waiting for a second dial tone on FXO outdial) – FXO only
<n>	Insert the n <sup>th</sup> captured sequence from the source expression

Example of use of the <n> token:

```
srce=IF:0501,TEL:9<.*> dest=IF:0401,TEL:<1>
```

*This dial plan looks for a call coming from the LAN (H.323) with a telephone number starting with a 9, but of non defined length. When this is detected a call will be made out of ISDN E1T11 (IF:0401) passing on the received telephone number excluding the leading 9. So, for an incoming H.323 call where the called-party number = 9123456, the outbound call will dial 123456 on ISDN E1T1 1.*

The above Regular Expressions / Wildcards can be used to create prefix and suffix patterns easily (and many more complex patterns), e.g.

```
srce=IF:0301,TEL:8<0[1-4]><.*> dest=IF:03<1>,TEL:<2>
```

*This dial plan (for a Vega 50 BRI) will take an incoming ISDN BRI 1 call and if the called party number begins with '801', '802', '803', or '804' it will use the second two digits dialled to specify the ongoing interface (01 to 04), and the remaining digits will be passed on as the called party number,*

*e.g. for an incoming call to ISDN BRI 1, where the called-party number = 803123, the outbound call will dial 123 on interface 0303 – ISDN BRI 3*

### 8.3.7 Adding a Cost Index

The cost index is a number in the range 1 to 9 & 0. The cost index is used to set the priority on the corresponding dial plan entry for matching to incoming calls. If zero is configured then the dial planner will automatically select the most appropriate entry for an incoming call using the [longest-match method](#). Any other value (1-9) sets a manual priority – 1 is the highest, 9 is lower; 0 (effectively 10) is the lowest.

Use “Show Paths” to see the resultant priority order of dial plan entries – see section [8.5.3](#)

## 8.4 Fixed Length vs Variable Length

The dial planner is designed to forward calls immediately when a match is detected to a fixed length source expression. For example `srce=TEL:123<...>` represents a fixed length source expression of 6 digits starting “123”. As soon as the last digit or character is received the Vega will begin forwarding the call to the corresponding outgoing interface.

In the case where a variable length source expression has been specified, for example `srce=TEL:123<.*>` the Vega will need to use some other kind of indication to know when to begin forwarding the call. Vegas support two mechanisms:

- 1) Source interface inter-digit timeout expiry.
- 2) Source interface block send character detected.

Both the timeout value and the block send character can be configured in the ISDN or POTS sections of the configuration database (depending upon the Vega being configured).

Only in the case of telephony interfaces are timeouts and block send characters used to forward calls. In the cases of H.323 and SIP, the dial planner automatically knows when to forward the call as dialled digits are sent “en-block”.

For incoming calls on POTS and ISDN interfaces always try to use fixed length source expressions because the call can be processed sooner, thus giving the caller a faster connection.

## 8.5 Longest match and cost matching

When an incoming call arrives at the gateway the dial planner scans the list of active profiles for a suitable match with a dial plan entry. If there is exactly one match suitable then this is chosen to progress the call. If more than one match is suitable then one of two algorithms is used to select the one to use cost matching or longest matching:

### 8.5.1 Cost Matching

If a manual cost in the range 1-9 has been entered for any matching dial plan entry then the lowest cost plan (ie highest priority) from this list is selected. In the case where more than one entry with the same cost exists, the first one encountered is used.

### 8.5.2 Longest Matching

If there are no manual costs in matching entries (i.e. all matching entries have a cost=0) then the dial planner uses the longest match algorithm to select a dial plan. This looks at the number of possible matches that can be derived from each source expression, and selects the one with the shortest list. For example:

```

TEL:12345      only one number can match, so the longest match cost is 1
TEL:1234[56]   two numbers can match (12345,12346), so the longest match
               cost is 2
TEL:1234.      sixteen numbers can match, so longest match cost is 16
               (12340,12341, ... ,12349,1234*,1234#,1234A, ... 1234D)

```

In the case where the longest match is the same for two or more addresses then the longest address is used.

### 8.5.3 Show Paths Command

The `SHOW PATHS` command is used to list dial plan entries in order of cost, (manual / longest match) either for all incoming interfaces, or for one particular specified interface.

The `SHOW PATHS` command, like `SHOW PLAN`, displays dial plan information from the runtime configuration memory; it is syntax checked and processed to indicate exactly how the Vega will act upon the dial plan information. If there are any syntax errors that will prevent the Vega using dial plan entries these will be indicated.

```

admin >show paths 0501

Sorted Dial Planner for interface: 0501

Source                Destination                Prof/
Int'face  Address                Int'face Address          Plan
-----
IF:0501  H323 [1,1] summary:
0501     TAC:PHONE_<...>,TEL:<.*> <1>    TEL:<2>                    1/1 (*DISABLED*)
<...>   TEL:.*                  0501     TA:PHONE_<1>,TEL:<1>    1/2 (*DISABLED*)
.*      TEL:<...><.*>           <1>     TEL:<2>                    2/1

```

#### NOTE

`SHOW PATHS` displays disabled profiles as well as enabled ones – the dial plan that the Vega will use is the first non-disabled entry that matches.

### 8.5.4 Try Command

The `TRY` command also displays the priorities for relevant dial plan entries whilst testing the dial planner using a sample incoming call address. For more details see section [8.12 Testing Plan Entries](#)

## 8.6 Dial planner Groups

Dial planner groups can be used to group together dial plan entries to provide redundant routing. The group of dial plan entries can be configured to allow calls to be re-presented to other dial plans in that group until the call gets through, or until all dial plan entries in that group have been tried.

Groups may also be used to enable and disable specific or sets of dial plans under specific system conditions.

### 8.6.1 Groups And Redundancy (Call re-presentation)

See also section 8.7 "Call Presentation Groups"

When a group is created it contains a name and a list of cause codes. Any number of plans can then be assigned to this group (each plan can only be a member of a single group).

When a call arrives the Vega will use its cost and longest match algorithms to select the most appropriate dial plan to use. If the call fails and the dial plan is part of a group, then before rejecting the call the Vega will look at the group configuration to see if another dial plan may be suitable to route the call.

If the call has failed with a cause code which matches one of those listed in the group definition then the next appropriate dial plan in that group (according to cost – manual / longest match) will be tried – without the calling party knowing that a new call is being attempted. Ultimately there will be one of three possible outcomes:

- 1) The call succeeds using one of the dial plans.
- 2) All dial plan entries within the group have been tried and failed; the originating call is failed and the reason for failure given to the calling party is the cause code from the last call attempted.
- 3) A call fails for a reason other than those listed in the group definition; the originating call is failed and the reason for failure given to the calling party is this cause code.

This functionality can therefore be used to build redundancy into the Vega product by specifying more than one route out of the Vega for a particular incoming call. (Typically in scenarios like this all dial plans within the group will have identical srce expressions and will use cost to prioritise the order in which they are used)

E.g. first available phone on call busy:

```
admin planner.profile.1 >cp .planner.group.1
admin planner.group.1 >set name=UserBusy cause=17
[planner.group.1].name=UserBusy
[planner.group.1].cause=17

admin planner.group.1 >profile 2
list item added

admin planner.profile.2 >plan 1
admin planner.profile.2.plan.1 >set srce=IF:0501,TEL:<.*> dest=IF:0101,TEL:<1> group=1
[planner.profile.2.plan.1].srce=IF:0501,TEL:<.*>
[planner.profile.2.plan.1].dest=IF:0101,TEL:<1>
[planner.profile.2.plan.1].group=1

admin planner.profile.2 >plan 2
admin planner.profile.2.plan.2 >set srce=IF:0501,TEL:<.*> dest=IF:0102,TEL:<1> group=1
[planner.profile.2.plan.2].srce=IF:0501,TEL:<.*>
[planner.profile.2.plan.2].dest=IF:0102,TEL:<1>
[planner.profile.2.plan.2].group=1

admin planner.profile.2 >plan 3
admin planner.profile.2.plan.3 >set srce=IF:0501,TEL:<.*> dest=IF:0103,TEL:<1> group=1
[planner.profile.2.plan.3].srce=IF:0501,TEL:<.*>
[planner.profile.2.plan.3].dest=IF:0103,TEL:<1>
```

```
[planner.profile.2.plan.3].group=1
admin planner.profile.2.plan.3 >apply

Applying planner configuration changes...
LOG: 03/04/2001 13:45:14 LOGGER (A)Rb2C00 config changes applied

admin planner.profile.2.plan.3 >
```

In this example any incoming call on interface 0501 (H.323) will be routed to the first found non-busy phone interface 0101, 0102, or 0103. The call will only be rejected if all interfaces 0101, 0102 and 0103 are unable to handle the call.

As well as using the CLI for configuration, groups may also be configured on the web browser interface – from the Dial Plan page.

Call representation can be used for calls being routed to the LAN interface as well as calls routed to the telephony interfaces, e.g. to present the call to different gateways to find a gateway to the PSTN that is not fully busy.

### 8.6.2 Cause Codes For Re-Presentation

```
[planner.group.1]
cause=3,34
```

Any Q.850 cause codes may be used to request re-presentation. Multiple cause codes may be specified as reasons for the call to be re-presented; do this by specifying them as a comma separated list of Q.850 cause codes (no spaces).

Frequently used values include:

3 – unreachable destination (e.g. on the LAN, the network may be down or the endpoint switched off, Sip proxy not accessible)

17 – endpoint busy

34 – PSTN network busy / no bandwidth on LAN

38 – Network out of order (on LAN also means Gatekeeper unreachable)

41 – Temporary failure (on LAN may be triggered by an “Adaptive Busy” message from the gatekeeper, indicating LAN congestion)

**See “IN 18 Q850 cause codes” for a full list of cause codes and what they mean**

In order to identify the cause code needed, it is often easiest to enable ‘log display on’ on a command line interface and then make the failing call. Look at the disconnect reason code – this is the Q.850 cause code to use.

## NOTE

1. On Vega FXS ports, cause code 18 – Ring Tone No Reply – cannot be used to re-present calls to telephony interfaces onboard that unit – if re-presentation is required, the unit sourcing the outdial request will have to receive the cause code 18 over the LAN interface and using a special prefix send it back to the Vega FXS ports to try a different port. Alternatively use the `dest_timeout` function in Call Presentation groups – see section 8.7 "Call Presentation Groups"
2. To handle SIP proxy not available, also consider using backup proxies as cause code 3 takes about 20 seconds (if the SIP timers are at their default values: T1=500, T2=4000)

### 8.6.3 Groups enabling and disabling dial plans

The group definition can also be used to specify when dial plan entries are enabled / disabled. The conditions LAN active / inactive, Gatekeeper active / inactive, and time of day can be configured – if the configured condition is met then the dial plan entries that are in that group are enabled, otherwise they are disabled. The parameters are:

**[planner.group.n]**

`lan=off/active/inactive`

`gatekeeper=off/active/inactive` (H323 specific)

`active_times=ssss-eeee`

If the `lan` entry is configured `active`, then dial plans belonging to this group are only enabled for routing calls when the LAN link is up. If `lan=inactive` is configured then dial plans belonging to this group are only enabled for routing calls when the LAN link is down. The `off` condition disables any checking of the `lan` condition (the status of the LAN will not disable the plans in this group).

For H323 firmware, if the `gatekeeper` entry is configured `active`, then dial plans belonging to this group are only enabled for routing calls when the gatekeeper is available and holds a valid gateway registration. If `gatekeeper=inactive` is configured then dial plans belonging to this group are only enabled for routing calls when the Vega has no valid gatekeeper registration. The `off` condition disables any checking of the gatekeeper registration condition (the status of gatekeeper registration will not disable the plans in this group)

`Active_times` allows an inclusive activation time period to be entered (based on the system clock displayed via SHOW TIME), where:

`ssss` = start time in 24hr format (e.g. 0700)

`eeee` = end time in 24hr format (e.g. 1700)



To activate dial plans outside of a particular time period then reverse the start/end times and adjust the times to avoid having both groups of dial plans active at the crossover minutes.

E.g.

0800-1800 enables dial plans in the period 8:00am to 6:00pm inclusive

1801-0759 enables dial plans for the remainder of the day, 6:01pm to 7:59am inclusive

The default is `ssss=0000` and `eeee=2359` – ie 24 hours permanently on.

When enabling multiple conditions, all conditions must be true for the dial plan to be enabled, e.g. If the `lan` entry is configured `active` and the `gatekeeper` entry is configured `active`, then both the LAN link has to be up and the gatekeeper has to be available for the dial plan to be enabled for routing calls.

NOTE

If selecting `gatekeeper=inactive`, dial plans in this group must only route calls via telephony ports – if there is no gatekeeper to validate calls via the LAN, as defined in the H.323 specs the calls will fail.



**WARNING!**

**The gatekeeper Active / Inactive feature may not be supported in this manner in future builds; it is better to use cause codes to represent calls where needed.**

## 8.7 Call Presentation Groups

Call Presentation Groups provide an easy method for configuring a Vega to present calls to or through multiple physical interfaces. This is particularly useful on a trunking gateway to allow the Vega to find a non busy port / trunk to route the call through, and on a gateway connected to endpoints to find a non-busy endpoint or an end-point where the call is answered.

When configuring Call Presentation Groups the destination interfaces are defined in an ordered list, and the sequence mode tells the Vega how to use them. The cause parameter tells the Vega whether to try another interface or whether to terminate the call if it fails to a specific interface.

Call Presentation Groups define 'Virtual Interfaces', and so they are used by specifying the required Call Presentation Group's interface ID as the destination IF: in a dial plan.



**WARNING!**

**Call Presentation Group 'virtual' interface IDs must only be used in destination dial plan entries.**

**To accept calls form multiple interfaces in a source dial plan use wild cards, e.g. to accept calls from IF:0301 and IF:0303 use IF:030[13] in the source expression.**

### 8.7.1 Configuring a Call Presentation Group

Specify the destination interfaces using `dest`, e.g.

```
dest = IF:0301|IF:0303
      (BRI interfaces 0301 and 0303)
```

Specify the causes that should allow the call to try a different interface, e.g.

```
cause = 27, 34, 41
        (27 = desination out of order, 34 = channel in use, 41 = temporary failure ... see also
         section 8.6.2 "Cause Codes For Re-Presentation")
```

Specify the virtual interface number, e.g.

```
interface = 1003
            (use a unique interface number)
```

Enable the Call Presentation Group, e.g.

```
enable = 1
```

Other parameters allow further control of the call presentation group:

Specify the way to use the list of interfaces, e.g.

```
seq_mode = linear_up
           (linear_up, round_robin or random)
```

Specify the maximum number of different interfaces the Vega should try in this CPG, e.g.

```
max_dest_attempts = 2
                   (typically this is the number of interfaces in the 'dest' list)
```

If the `dest_timeout` timeout occurs (endpoint just rings forever) define what to do, e.g.

```
dest_timeout_action = try_next_dest
                    (either try next CPG destination, or hangup ... hangup means exit this CPG
                     (call re-presentation can re-present call if required))
```

Specify the time to leave destination ringing, e.g.

```
dest_timeout = 180
              (180 sec = 3 minutes)
```

Specify a name, e.g.

```
name = find_free_PSTN
      (for self documentation choose a name that defines what this CPG does)
```

### 8.7.2 Interaction of Call Presentation Groups and Call re-presentation

Call Presentation Groups are called up by specifying them as the IF: in the `dest` part of a dial plan entry. If the Call Presentation Group exits (because it has exceeded the number of interfaces to try, has received a clear-down reason not listed in the cause list or has reached the `dest_timeout` and `dest_timeout_action` is `hangup`) then if the dial plan entry is in a call re-presentation group, the call re-presentation will be actioned.

## 8.8 Hot-Line Facility (Long-line extension)

Vega products support a “hot-line” facility which allows the dial tone played to the calling party to be sourced from the destination PBX / Network rather than from the local Vega itself. (This is especially useful where the PBX or Network uses special forms of dial tone, for example stuttered dial tone to indicate voice mail “message waiting”).

When the handset of a phone attached to a Vega FXS port configured for “hot-line” is lifted, the FXS port will immediately route the call to a specified destination. This is typically used together with a Vega 50 BRI, Vega 400 or a Vega 50 FXO also configured in “hot-line” mode – the destination gateway seizes the line towards the PBX or Network and the dial tone so produced is routed back over the VoIP network to the calling party. Any digits now dialled will be passed to the PBX or Network that is playing the dial tone.

### NOTE

1. To allow the dial tone to be passed over the VoIP network, early media must be configured in the VoIP gateways (e.g. `use_faststart`, `accept_faststart="after proceeding"`, `use_early_h245` and `accept_early_h245`)
2. DTMF must be configured as out-of-band if the destination unit is a Vega 400, or Vega 50 BRI so that the destination unit can use the digits as dialled digits rather than passing through the DTMF tones.

### 8.8.1 Vega FXS Port Hot-Line

The Vega FXS port is configured for “hot-line” operation by omitting the telephone number or telephone number token from the source dial plan expression.

e.g. `srce=IF:0101,TEL:`

or `srce=IF:0101`

### NOTE

1. SIP does not support null or zero length dialled numbers, so when the hot-line call is forwarded over SIP, a dummy telephone number must be sent. E.g. `srce=IF:0101,TEL: dest=IF:9901,TEL:\*` sends a Star DTMF character if hotline is configured

### 8.8.2 Vega FXO Port Hot-Line

Vega FXO ports support “hot-line” mode to allow VoIP calls to be routed to the destination PBX or Network without a dialled number being passed.

To activate the hot-line facility simply omit the telephone number or telephone number token from the destination dial plan expression:

e.g. `dest=IF:0201,TEL:`

or `dest=IF:0201,TEL:~`

or `dest=IF:0201`

(or `dest=IF:0201,TEL:<1>` ; where <1> is empty)

When the call arrives, the Vega will just seize the line (without dialling any digits) and this will provoke a dial tone response. Subsequent DTMF digits received by the Vega FXO port will then be played to the PBX or Network, which it will interpret as dialled digits.

### 8.8.3 Vega 50 BRI and Vega 400 Hot-Line

Vega 50 BRI, and Vega 400 gateways support “hot-line” mode to allow VoIP calls to be routed to the destination network without a dialled number being passed.

**NOTE**

Dial tone is readily available from BRI networks, but only sometimes available from PRI networks.

To activate the hot-line facility simply omit the telephone number or telephone number token from the destination dial plan expression:

e.g. `dest=IF:0401,TEL:`

or `dest=IF:0401`

(or `dest=IF:0401,TEL:<1>` ; where <1> is empty)

When the call is forwarded from the Vega to the ISDN PBX or Network it will send a SETUP message with no dialled digit information, and this will provoke a dialtone response. Subsequent out of band DTMF digits received by the Vega will then be sent to the ISDN PBX or Network as dialled digit information (provided that early media is established on the incoming H.323 or SIP side of the gateway).

## 8.9 Overlap Dialling

The default behaviour of Vega gateways is to use enbloc dialling, where all digits are sent when the call is in the setup phase. This can cause unacceptable post dial delay (PDD) in some countries. To overcome this Vegas can be configured to use overlap dialling when originating calls.

Outgoing call setup using overlap dialling is now supported for the following call types:

- TDM to SIP
- SIP to TDM
- TDM to TDM

The following TDM interfaces support overlap dialling:

- ISDN (where allowed by the protocol)
- FXO
- FXS

Once enabled the behaviour of this feature is controlled via the dial plan:

- Any call matching a dial plan containing “.” in the source TEL token will be treated as an overlap call.
- Any digits preceding the “.” will be collected before the call is routed
- This provides control for when the routing decision is taken

### 8.9.1 Configuration

Parameter:

`planner.allow_tx_overlap`

Possible values:

- 0 - Default - Disable overlap dialling
- 1 - Enable overlap dialling transmission for all valid interfaces

Parameter:

`_advanced.sip.overlap.allow_tx`

Possible values:

- 0 - Default - Disable outbound SIP overlap dialling
- 1 - Enable overlap dialling for outbound SIP calls

Parameter:

`_advanced.sip.overlap.allow_rx`

Possible values:

- 0 - Default - Disable inbound SIP overlap dialling
- 1 - Enable overlap dialling for inbound SIP calls

### 8.9.2 Example Usage

User Dials	Vega Dial Plan	Vega Routes Call on Reception of
01344 784900	TEL:<.*>	0
00 1 877 834 4470	TEL:00<.*>	00
00 1 877 834 4470	TEL:<....*>	001

### 8.9.3 Sample Call Flow for SIP Overlap Dialling

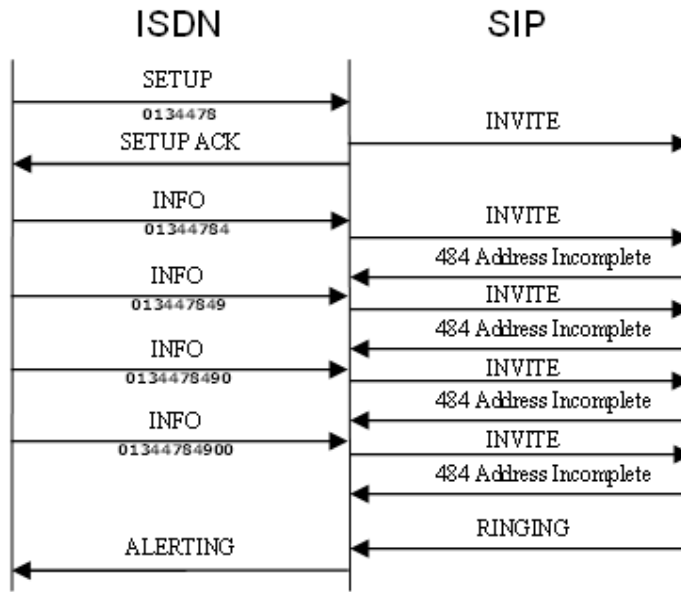

TRYING and ACK  
messages omitted for clarity

## 8.10 LocalDNS Name Table or DNS-based Indirection

The LAN configuration section contains a local DNS table of host names and IP addresses. This provides local (internal) DNS lookup for name to IP and IP to name. Lookups in this local DNS table take priority over use of the external DNS server (whose IP address may also be set up). This allows names to be used in dial plans instead of dotted decimal IP addresses.

The advantage of using names is that IP address dependencies can be moved to a single table (the local DNS table), and all plans can be based on a level of indirection using names, e.g. using a DNS table to route calls to an IP phone from a fixed POTS line:

```
admin >set lan.localDNS.2.ip=200.100.50.12
[lan.localDNS.2].ip=200.100.50.12
admin >set lan.localDNS.2.name=PHONE_0101
[lan.localDNS.2].name=PHONE_0101
admin >apply
```

Applying planner configuration changes...

LOG: 03/04/2001 13:50:55 LOGGER (A)Rb2C00 config changes applied

```
admin >show hosts
```

Host table:

Index	IP address	Host name
1	127.0.0.1	loopback
2	200.100.50.12	PHONE_0101
3	0.0.0.0	PHONE_0102
4	0.0.0.0	PHONE_0103
5	0.0.0.0	PHONE_0104
6	0.0.0.0	PHONE_0105
7	0.0.0.0	PHONE_0106
8	0.0.0.0	PHONE_0107

```
admin >
```

Now the token TA:PHONE\_0101 can be used in dial plans to route calls to the IP phone, and the token TAC:PHONE\_0101 to recognise calls coming from the IP phone. This gives enormous power to the dial planner because it means network addresses can be independent of any particular IP numbering scheme already in place on the LAN.

This capability also allows the interface number to be used to select the correct IP address where the IP address bears no similarity to the interface number.

An example dial plan using the above would be:

```
Profile 1: Vega50_default (enabled)
```

Index	Grp	Source	Destination
/Cost		Int'face Address	Int'face Address
1/0	0	<.[^5]..> TEL:<.*>	05 TA:PHONE_<1>,TEL:<2>
2/0	0	0501 TAC:PHONE_<...>,TEL:<.*>	<1> TEL:<2>

In this general example all calls to / from transport addresses PHONE\_xxxx will be routed from / to interfaces defined by xxx. The mapping of PHONE\_xxxx to / from IP address being held in the local DNS table

**NOTE**

For external DNS to be used in this way (as opposed to just the local DNS table), then the external DNS server must support reverse lookup, and reverse lookup must be enabled in the `_advanced.lan` section of the configuration database.

## 8.11 National / International Dialling – Type Of Number

In ISDN setup messages, alongside the dialled number field there is a “Type Of Number (TON)” field. Most switches and PBXs rely solely on the dialled number to identify where the call is to be routed to by analysing the local / national / international prefix in the dialled number. Some CO switches however, require the TON field to identify the format of the number “National”, “International” or one of a number of other formats.

The Vega supports the population of the TON field using both a static method (populating `_advanced.setup_mapping` parameters) and a dynamic method (using the `planner.post_profile` dial plan).

SIP Vegas also support the ability to apply prefixes to calling party telephone numbers based on whether the calling party TON identifies the call as National or International.

### 8.11.1 `_advanced.setup_mapping`

Static mapping allows telephone number parameters (including Type Of Number, Numbering Plan information, and Presentation and Screening information) to be set up on a per ISDN LINK basis. Parameters for both called party number and calling party number can be configured.

```
[_advanced.setup_mapping.x.calling_party_number]
type = type of number
plan = numbering plan
presentation = presentation status
screening = screening status
```

```
[_advanced.setup_mapping.x.called_party_number]
type = type of number
plan = numbering plan
```

Setting a parameter to “supplied” causes the value NOT to be overridden by this static setting – passing through the value that has come from the incoming call, or if appropriate from the `planner.post_profile`.



Multiple mappings can be set up in the Vega (`setup_mapping.x`). Specific E1T1S / BRISs are then configured to use specific setup mappings using:

```
[e1t1/bri.port.n.isdn]
  setup_mapping_index=x
```

As H.323 uses ISDN signalling (Q.931) to pass its signalling data, a setup mapping can also be selected for calls placed over the lan; use:

```
[h323.if.x]
  setup_mapping_index=x
```

### 8.11.2 planner.post\_profile

`Planner.post_profile` is more flexible than `_advanced.setup_mapping` in that it operates on a per call basis.

`Planner.post_profile` operates in a very similar, but more restricted, manner to standard dial plans; `planner.post_profile` supports both `srce` and `dest` parameters. `srce` can use any of the conditions that the standard dial plan can, though typically only `IF:` and `TEL:` will be needed. `Dest` supports the tokens:

TYPE:	Called Party Type Of Number ... which can take the values <code>national</code> , <code>international</code> , <code>network_specific</code> , <code>subscriber</code> , <code>abbreviated</code> , and <code>unknown</code> .
PLAN:	Called Party Numbering Plan ... which can take the values <code>isdn_telephony</code> , <code>data</code> , <code>telex</code> , <code>national</code> , <code>private</code> , and <code>unknown</code> .
TYPEC:	Calling Party Type Of Number ... which can take the values <code>national</code> , <code>international</code> , <code>network_specific</code> , <code>subscriber</code> , <code>abbreviated</code> , and <code>unknown</code> .
PLANC:	Calling Party Numbering Plan ... which can take the values: <code>isdn_telephony</code> , <code>data</code> , <code>telex</code> , <code>national</code> , <code>private</code> , and <code>unknown</code> .
PRESC:	Calling Party Presentation indicator ... which can take the values <code>allowed</code> , <code>not_available</code> , <code>restricted</code> .
SCRNC:	Calling Party Screening indicator ... which can take the values <code>failed</code> <sup>5</sup> , <code>not_screened</code> , <code>passed</code> , and <code>network</code> .
TELC:	Caller ID
DISP:	Display field

`Planner.post_profile` effectively works in parallel with the existing dial planner, i.e. the source data provided to `planner.post_profile` is exactly the same as that provided to the standard dial plan; the standard dial plan will carry out the number translation, authentication and

---

<sup>5</sup> 'failed' is not a valid ETSI value (even though it is defined in Q.931)

routing. The `planner.post_profile` will just populate the TON, NPI, CallerID Presentation, Caller ID Screening, Caller ID and Display IE fields.

NOTE
------

If both `_advanced.setup_mapping` and `planner.post_profile` are used then it should be noted that the `_advanced.setup_mapping` values are applied after the `planner.post_profile` values. To pass through the value applied by the `planner.post_profile` TYPE: PLAN:, TYPEC and PLANC then

```
_advanced.setup_mapping.x.calling_party_number.type=supplied
_advanced.setup_mapping.x.calling_party_number.plan=supplied
_advanced.setup_mapping.x.called_party_number.type=supplied
_advanced.setup_mapping.x.called_party_number.plan=supplied
```

must be set.

### 8.11.2.1 Commands associated with `planner.post_profile`

Post profile

Similar to the `profile x` command, goes to `planner.post_profile`.

```
e.g.  admin > post profile
      admin planner.post_profile >
```

Plan x

This command works for both standard dial plans and for post profile.

```
e.g.  admin planner.post_profile > plan 2
      admin planner.post_profile.plan 2 >
```

Show plan

Shows both standard dial plan entries and `post_profile` entries.

Show post paths

Shows a priority ordered list of all plans in the post profile.

### 8.11.2.2 Example planner.post\_profile

```
[planner.post_profile]
  enable=1

[planner.post_profile.plan.1]
  name=International
  enable=1
  srce=TEL:011.*
  dest=TYPE:international

[planner.post_profile.plan.2]
  name=national
  enable=1
  srce=TEL:1.*
  dest=TYPE:national
```

### 8.11.3 Calling Party Telephone number prefix based on TON

For SIP products there are configuration parameters that allow telephone number prefixes (national prefix and international prefix) to be defined which are applied to the SIP Caller ID - based on the calling party TON value received in the incoming ISDN call.

```
[_advanced.sip]
  international_prefix=off/digits
  national_prefix=off/digits
```

For calls that are received from an ISDN E1T1/BRI and which the dial planner then routes to the LAN, the SIP stack will apply the appropriate prefix (if not switched off) defined by the above configuration parameters.

e.g.

Assuming the Vega is situated in Germany, has a configuration where the registration domain is `vegastream.com` and `international_prefix=00` and `national_prefix=0049` (for Germany). If a call is received by that Vega on an ISDN E1T1/BRI that the dial planner then routes to the LAN (without altering the called number), then:

If the Vega receives a call from a national number:

```
TELC: = 300000000
type = NATIONAL
```

then, the SIP 'From' field would be populated as follows:

```
<sip:0049300000000@vegastream.com:5060> ; 0049 prefix added
```

And if the Vega receives a call from an international number (e.g. from England):

```
TELC: = 441344784900
type = INTERNATIONAL
```

then, the SIP 'From' field would be populated as follows:

```
<sip:00441344784900@vegastream.com:5060> ; 00 prefix added
```

**NOTE**

The prefix is added to the calling party number after the dial planner has made any changes that it is going to.

## 8.12 Testing Plan Entries

The TRY command can be used to test the dial planner by presenting a simulated incoming call to it. The TRY command takes a series of tokens as parameters, the IF: token for the incoming interface and any combination of TEL:, NAME:, TA:, TAC:, NAMEC:, TELC:, and DISP: tokens for the called party number address.

The TRY command returns a list of matched destinations, in order of cost.

e.g.      TRY IF:0501,TEL:1344784900,TELC:1344784901

NOTE

TRY displays disabled profiles as well as enabled ones – the dial plan that the Vega will use is the first non-disabled entry that matches.

## 8.13 Call Security – Whitelist Access Lists

Additional call security is available on the Vega using the whitelist facility. A whitelist contains a list of allowed addresses, i.e.:

```
[planner.whitelist.1]
    number=address_1
[planner.whitelist.2]
    number=address_2
```

Where *address1* and *address2* consists of dial planner tokens, typically IF:, TEL:, TAC: and NAME: - these specify the addresses to allow. Only callers matching one (or more) of the expressions in the whitelist will be allowed access to the system.

By default the list is set up to allow any caller on any interface as follows:

```
[planner.whitelist.1]
    number=IF:.*
```

Up to 50 whitelist entries may be made.

Example:

```
[planner.whitelist.1]
    number=IF:[^5]..          ; allow all telephony calls
[planner.whitelist.2]
    number=IF:0501,TAC:34.86.210.5    ; allow H.323 calls only from the
                                       ; VoIP device at 34.86.210.5
```

## 9 LOGGING AND STATISTICS

### 9.1 System Event Log

The system event log is a circular buffer showing the last significant n events occurring in the system. Each log entry is categorised by the seriousness of the event, and the area of the system that generated it.

The log can be displayed either by enabling the log display to the console as and when events occur (LOG DISPLAY ON), or display the whole log by typing SHOW LOG.

The log can be turned off by typing LOG OFF, turned on by typing LOG ON and cleared by typing LOG CLEAR. Filters can be specified to [limit the events put into the LOG buffer](#), and to [limit the events to be displayed to the console](#).

When the event log fills up it wraps around and the oldest event records are lost.

```
admin >show log

EVENT LOG: enable=ON display=A
LOG: 01/01/1999 00:00:00.000 DSP      (A)Rb3C3c 60 channels (60 licensed)
LOG: 01/01/1999 00:00:04.095 LCD      (I)R00C00 LCD      running
LOG: 01/01/1999 00:00:04.095 ISDN     (I)R00C00 ISDN     running
LOG: 01/01/1999 00:00:04.095 PACING   (I)R00C00 PACING   running
LOG: 01/01/1999 00:00:04.095 DSPDOWN (I)R00C00 DSPDOWN  running
LOG: 01/01/1999 00:00:04.095 DSP      (I)R00C00 DSP      running
LOG: 01/01/1999 00:00:04.095 REDIRECT (I)R00C00 REDIRECT running
LOG: 01/01/1999 00:00:05.655 LAN      (I)R16C00 DHCP assigned ip      192.168.1.106
LOG: 01/01/1999 00:00:05.655 LAN      (I)R16C00 DHCP assigned subnet  255.255.255.0
LOG: 01/01/1999 00:00:05.655 LAN      (I)R16C00 DHCP assigned gateway 192.168.1.1
LOG: 01/01/1999 00:00:05.655 LAN      (I)R16C00 DHCP assigned dns     216.148.227.68
LOG: 01/01/1999 00:00:05.655 LAN      (W)R6cC00 DHCP ntp discovery failed
LOG: 01/01/1999 00:00:05.655 LAN      (W)R6cC00 DHCP tftp discovery failed
LOG: 01/01/1999 00:00:05.655 LAN      (W)R6cC00 DHCP ftp discovery failed
LOG: 01/01/1999 00:00:05.665 LANPROXY (I)R00C00 LANPROXY running
LOG: 01/01/1999 00:00:05.672 LAN      (I)R00C00 LAN      running
LOG: 01/01/1999 00:00:05.675 LOGGER  (I)R17C00 REBOOT cause 0: coldstart
LOG: 01/01/1999 00:00:05.675 LOGGER  (I)R00C00 LOGGER  running
LOG: 01/01/1999 00:00:05.745 WEBSERV  (I)R00C00 WEBSERV  running
LOG: 01/01/1999 00:00:05.747 CONSOLE  (I)R00C00 CONSOLE  running
LOG: 01/01/1999 00:00:06.350 LAN      (A)Rb4C00 LAN link-up (10Mbps)
LOG: 01/01/1999 00:00:07.572 SNMP     (I)R00C00 SNMP     running
LOG: 01/01/1999 00:00:28.710 SIP      (I)R00C00 SIP      running
LOG: 01/01/1999 00:00:28.865 ROUTER  (I)R00C00 ROUTER  running
LOG: 01/01/1999 00:00:28.865 ROUTER  (I)R10C00 detected system clock speed = 150MHZ
LOG: 01/01/1999 00:00:28.865 ROUTER  (A)RabC00 system ready for use
LOG: 01/01/1999 00:00:29.872 LOGGER  (A)Rb1C00 Blocked, no active calls
LOG: 01/01/1999 00:01:50.270 CONSOLE  (A)RbbC11 autoexec - tftp or ftp server or file not found
```

## Vega Admin Guide R8.5 V1.5

```
LOG: 01/01/1999 00:03:10.680 CONSOLE (A)RbbC11 autoexec - tftp or ftp server or file
not found
LOG: 01/01/1999 00:03:28.355 TELNET (I)R01C01 incoming
      srce=192.168.1.108 port 2328 [0]
LOG: 01/01/1999 00:03:48.455 TELNET (I)R01C01 disconnected [0]
LOG: 01/01/1999 00:19:42.257 CONSOLE (A)Rb7C00 an 'admin' user has just logged
in.
LOG: 01/01/1999 00:21:29.225 WEBSERV (A)Rb7C09 an 'admin' user has just logged
in.
LOG: 01/01/1999 00:21:59.427 TELNET (I)R01C01 incoming
      srce=192.168.1.108 port 2445 [0]
LOG: 01/01/1999 00:22:04.967 TELNET (A)Rb7C01 an 'admin' user has just logged
in.
LOG: 01/01/1999 00:25:29.042 ISDN (A)RadC01 ISDN1 link-up (TE*) [X.....
.....X.....]
LOG: 01/01/1999 00:25:35.302 ISDN (A)RadC02 ISDN2 link-up (NT ) [X.....
.....X.....]
LOG: 01/01/1999 00:28:30.680 ROUTER (I)R0bC00 FINDROUTE profile:2(201) plan:1
      call ref=[f1000023]
      <-- SIP [1,1] dest=TEL:201
      --> ISDN [1,1] dest=TEL:201
LOG: 01/01/1999 00:28:30.690 ISDN (I)R02C20 outgoing
      call ref=[f1000023]
      dest=TEL:201
LOG: 01/01/1999 00:28:30.775 ROUTER (I)R0bC00 call proceeding
      call ref=[f1000023]
LOG: 01/01/1999 00:28:33.110 ISDN (I)R03C20 connect g711Alaw64k
      call ref=[f1000023]
LOG: 01/01/1999 00:28:33.177 SIP (I)R03C14 connect g711Ulaw64k
      call ref=[f1000023]
LOG: 01/01/1999 00:28:34.582 ISDN (I)R04C20 disconnect 16
      call ref=[f1000023]

admin >
```

Each log entry consists of a time stamp, system area that generated the event, and an event summary which reads as follows:

```
(<seriousness>)R<reason code>C<channel number> <message>
```

Where:

seriousness = I information, W warning, E error, X fatal error, A alert

reason code = unique reason code

channel number = channel affected (if any); zero for no channel

message = text summary of event

E.g. LOG: 01/01/1999 17:11:28.045 ISDN (W)R67C01 ISDN link down  
ISDN reported a Warning that ISDN link 01 went down (reason 67)

For call related ISDN event logs the 'C' part of the identifier is the channel number affected (in hexadecimal), e.g.:

```
LOG: 01/10/2004 14:08:34.697 ISDN      (I)R01C3e incoming
      call ref=[f10f033b]                srce=TEL:1842851736 [0]
```

The 'C', channel numbers can be decoded to identify the E1T1 to which this log message refers.

E1		T1	
'C' number (in hex)	E1T1	'C' number (in hex)	E1T1
00 to 1f	1	00 to 17	1
20 to 3f	2	18 to 2f	2
40 to 5f	3	30 to 47	3
60 to 7f	4	48 to 5f	4

For E1 systems, 'C' values ending in 0 are used for signalling and link synchronisation and so will not be seen in log display on traces.

For T1 PRI systems 'C' values of 17, 2f, 47 and 5f are used for signalling and link synchronisation and so will not be seen in log display on traces.

So channel 0x3e on an E1 system is channel 0x1e on E1T1 2 i.e. channel 30 on E1T12, and channel 0x3e on an T1 system is channel 0xe on E1T1 3 i.e. channel 14 on E1T13.

A full list of <reason code> and <seriousness> values can be found in the [System Event Log Messages Appendix](#).

Trunk related messages contain a field in the form:

```
(TE*) [X.....X.....]
```

This is explained in section [9.2.2 "Statistics - show ports"](#).

FINDROUTE messages contain a field in the form:

```
[1,1]
```

This is explained in section [9.1.1 "Call Tracing using the Event Log"](#).

### 9.1.1 Call Tracing using the Event Log

Call scenarios typically generate (I) information level messages which can be used to trace the history of a successful or unsuccessful call. An example successful call trace is as follows:

```
LOG: 03/04/2001 20:39:02 H323      (I)R01C01 incoming
      call ref=050001.....          srce=TA:172.16.30.8,NAME:ChrisC
LOG: 03/04/2001 20:39:02 ROUTER    (I)R0bC00 FINDROUTE profile:2(new_profile) plan:1
      call ref=050001.....          <-- H323      [1,1] dest=TEL:123
```

```

--> POTS [1,1] dest=TEL:123
LOG: 03/04/2001 20:39:02 ROUTER (I)R0bc00 Call proceeding
      call ref=0500010600ff
LOG: 03/04/2001 20:39:32 POTS (I)R03C01 connect g711Alaw64k
      call ref=050001060001
LOG: 03/04/2001 20:39:33 H323 (I)R03C01 connect call
      call ref=0500010600ff
LOG: 03/04/2001 20:39:34 H323 (I)R15C01 connect media g7231
      call ref=0500010600ff
LOG: 03/04/2001 20:40:01 H323 (I)R04C01 disconnect 16
      call ref=0500010600ff
LOG: 03/04/2001 20:40:01 POTS (I)R04C01 disconnect 16
      call ref=050001060001

```

This is a log trace from an incoming NetMeeting call to a Vega 50. The call was answered on the first POTS interface and then dropped from the NetMeeting end (H323 disconnect). Each message represents a different stage for the call.

Immediately following each log message for the call, is a call reference number; this number is unique for that call. By using the call reference number, log messages for the same call can be collated (very useful when multiple calls are triggering log events at the same time).

The call reference number is of the form [f1xxxxxx], where xxxxxx is unique for all calls in progress on the system. The call reference is generated as the incoming call arrives on the Vega and is used for all events related to this call.

e.g.:

```

LOG: 01/01/1999 00:04:34.582 ISDN (I)R04C20 disconnect 16
      call ref=[f1000023]

```

In the FINDROUTE messages the physical interface, and sub group of that interface being used are indicated in square brackets: [p,g]

e.g.

```

--> POTS [1,1] dest=TEL:123 ; indicates physical interface 1, group 1 – 1st POTS port, group 1 (IF:0101)
--> POTS [2,1] dest=TEL:123 ; indicates physical interface 2, group 1 – 2nd POTS port, group 1 (IF:0102)
--> POTS [2,2] dest=TEL:123 ; indicates physical interface 2, group 2 – 2nd POTS port, group 2 (IF:nnnn)
--> ISDN [1,1] dest=TEL:123 ; indicates physical interface 1, group 1 – 1st E1T1, group 1 (IF:0401)
--> ISDN [2,3] dest=TEL:123 ; indicates physical interface 2, group 3 – 2nd E1T1, group 3 (IF:mmmm)

```

Calls typically follow the same message flow:

- 1) Incoming call indication on incoming interface. This usually shows the source addressing information – corresponding to the A party (calling party).
- 2) ROUTER (or dial planner) log showing resolution of addresses for the destination B-party (called party).



- 3) ROUTER call proceeding – indicating all the information is now present to attempt an outgoing call.
- 4) Outgoing interface connection showing the CODEC selected for this part of the call.
- 5) In the case of an H.323 call, a media up connection message is displayed.
- 6) Incoming interface connect confirmation showing the CODEC selected for this part of the call.

At this stage the call is up.

When disconnecting the following sequence can be seen:

- 1) Disconnect log message from the interface originating the disconnection, with a Q.850 reason code.
- 2) Disconnect log message from the interface at the end not originating the disconnection, with the same Q.850 reason code.

See Information Note IN 18 for a list of disconnection reason codes, and the [System Event Log Message Appendix](#) for a list of all LOG message definitions.

### 9.1.2 Reboot cause codes

On Vega start up a LOG event is generated giving the reason for the last reboot. Messages follow the LOG message structure:

```
LOG: <time> <code area generating msg>
      (<seriousness>)R<reason code>C<channel number> <message>
```

Where <seriousness> = I or A

and <reason code> = 23

<message> is of the format:

```
REBOOT cause <cause ID> <information>
```

The <cause ID> values are:

- 0 coldstart
- 1 watchdog
- 2 user request
- 3 fatal error

<information> varies with the cause reason

<cause ID>	<information>
0	Coldstart
1	Watchdog
2	user: <parameters from the user requested command> ← see below
3	Fatal: <firmware generated message>

The `<parameters from the user requested command>` text is the concatenation of all the arguments available in the user function.

For example:

- a) In the case of "reboot system ... rest of line", `<parameters from the user requested command>` are "system ... rest of line"
- b) In the case of "download firmware `<image file>` ... rest of line", `<parameters from the user requested command>` are "`<image file>` ... rest of line"

In both cases this means that anything after the last parameter used by the command is effectively a comment that will be reported in the log

eg

```
reboot system explanation of reason
```

results in `<message>` being:

```
REBOOT cause 2: user: system explanation of reason
```

and

```
download firmware vega400.abs reboot explanation of reason
```

results in

```
REBOOT cause 2: user: vega400.abs reboot explanation of reason
```

NOTE
------

Watchdog and fatal reboots are reported in the log as  
`<seriousness>` = A, Alert, user and coldstart are  
`<seriousness>` = I, Info

## 9.2 Statistics

The following general status reports are available:

### 9.2.1 Show Calls

"**SHOW CALLS**" - provides a summary of call progress through the gateway

```
admin >show calls
```

```
Call Summary for : Vega100T1E1
```

Type	Active Ints	Total In Prog	Incoming			Outgoing		
			Att	Disc	Conn	Att	Disc	Conn
ISDN	2	2	0	0	1	0	0	1
POTS	0	0	0	0	0	0	0	0
H323	0	0	0	0	0	0	0	0
SIP	1	2	0	0	1	0	0	1
Total	3	4	0	0	2	0	0	2

```
End-to-end      2
Vega100T1E1 has been running for 0 days, 02:38:46 hh:mm:ss
admin >
```

**Where:**

Active Ints = Active interfaces

Att = Attempting to make a call

Disc = Disconnecting the call

Conn = Connected call

**9.2.2 Show Ports**

"SHOW PORTS" - provides a list of active/inactive port status' for all physical ports, and also a list of connections to the user interface.

e.g. for a Vega 4 BRI interfaces, 4 FXS interfaces and 2 FXO interfaces:

```
admin >show ports

Physical ports:

Name      Type  Status
-----
ISDN-1    WAN  link-down      (TE ) [X..]
ISDN-2    WAN  link-down      (NT ) [X..]
ISDN-3    WAN  link-up        (TE*) [X..]
ISDN-4    WAN  link-up        (NT ) [X..]
POTS-1    POTS (FXS) on-hook  ready
POTS-2    POTS (FXS) on-hook  ready
POTS-3    POTS (FXS) on-hook  ready
POTS-4    POTS (FXS) on-hook  offline (not enabled)
POTS-5    POTS (FXO) on-hook  ready
POTS-6    POTS (FXO) on-hook  offline (low line voltage)
SIP -1    LAN  100Mbit Half Duplex
SIP -2    LAN  link-down

DSL settings:
BRI 1: Top=BRIS Net=ETSI Line=AZI Frm=S/T  lyrl=g711Alaw64k
BRI 2: Top=BRIS Net=ETSI Line=AZI Frm=S/T  lyrl=g711Alaw64k
BRI 3: Top=BRIS Net=ETSI Line=AZI Frm=S/T  lyrl=g711Alaw64k
BRI 4: Top=BRIS Net=ETSI Line=AZI Frm=S/T  lyrl=g711Alaw64k

DSL statistics:

Port      Frames      TX          RX
          Bytes SLIPs    Frames Bytes SLIPs CRC Error Bad Frames
-----
BRI-1      0           0  --         0     0   0     0   0
BRI-2      0           0  --         12    36   0     0   0
BRI-3     271        1082  --        271  1082  0     0   0
BRI-4     271        1082  --        271  1082  0     0   0

Physical interfaces:

device      RJ45 Connectors      RJ21 Connector
-----
ISDN port  1 (BRI) RJ45 port  1      N/A
ISDN port  2 (BRI) RJ45 port  2      N/A
ISDN port  3 (BRI) RJ45 port  3      N/A
ISDN port  4 (BRI) RJ45 port  4      N/A
POTS port  1 (FXS) RJ45 port  5      RJ21 (1) pins 5 & 30
POTS port  2 (FXS) RJ45 port  6      RJ21 (1) pins 6 & 31
POTS port  3 (FXS) RJ45 port  7      RJ21 (1) pins 7 & 32
POTS port  4 (FXS) RJ45 port  8      RJ21 (1) pins 8 & 33
POTS port  5 (FXO) Dual FXO port 1      N/A
POTS port  6 (FXO) Dual FXO port 2      N/A

System Fan: Normal
System Temperature: Normal

Connections active:

ID  Port  Address      User      Connection start time
-----
1   RS-232
2   Telnet 192.168.1.108 admin     01/01/1999 00:22:04
10* WWW 172.19.1.68 admin     18/01/2006 15:45:49

vega5002 has been running for 0 days, 00:50:41 hh:mm:ss

Statistics Cleared: Never
```

For more details on the “Connections active” section, see [7.4 RADIUS Login Authentication](#)

The Vega can optionally be configured to use a RADIUS server to authenticate users when logging in. On logging in the Vega sends the username and password to the configured radius server for verification rather than holding the password locally. The permissions for the user will be held locally on the Vega.

There is a 2 second timeout for the radius login. If the Vega doesn't receive a radius server response in 2 seconds, the login will fail.

A new CLI command has also been added that allows the configured radius server to be tested. Radius based login should be thoroughly tested before using. Failure to test may result in permanent lock out from the Vega.

### 9.2.3 Configuration

Parameter added:

```
users.radius_login
```

Possible values:

```
0 - Default - Do not use radius based authentication
1 - Use radius authentication
```

Parameter added:

```
logger.radius.server.1.auth_port
```

Possible values:

```
1 to 65535 - Port to use for radius authentication - Default 1813
```

### 9.2.4 Test Command

A new command has been added to the Vega – `radius login test` – to check operation of the configured radius server and users. This command causes a radius message to be sent to the configured radius server containing the credentials entered.

#### Example

Assume a user has been setup with username of "admin" and correct password of "callme123". Issue the `radius login test` command with the correct credentials:

```
admin >radius login test admin callme123
RADIUS username and password ok.
```

Vega confirms configuration is correct.

Now issue the `radius login test` command with incorrect credentials (wrong password):

```
admin >radius login test admin callme124
RADIUS login test failed.
```

Vega indicates that login would have failed. The same message would be received if the radius server was incorrectly configured.

	<p><b>Do not enable radius login until the radius server has been configured and tested using the above command. If radius login is enabled but not correctly configured, the Vega will become inaccessible.</b></p>
<p><b>WARNING!</b></p>	

Logged on users.

Show ports for ISDN units includes a section on ISDN statistics, including the number of frames and bytes sent and received, the number of synchronisation slips, CRC errors and bad frames observed (the counters can be reset to clear initial power on occurrences using [clear stats](#)):

```
admin >show ports

Physical ports:

Name          Type  Status
-----
ISDN-1        WAN  link-up  (TE*) [X.....X.....]
ISDN-2        WAN  link-up  (NF ) [X.....X.....]
H323-1        LAN  link-up  (10Mbps)

ISDN statistics:

Port          Frames      TX          RX
              Bytes SLIPs   Frames      Bytes SLIPs  CRC Error Bad Frames
-----
ISDN-1        178         710     1   178         710     1         0         0
ISDN-2        178         710     0   178         710     0         0         0

Connections active:

ID  Port  Address          User          Connection start time
---
1 * Telnet 192.168.1.108  admin          01/01/1999 00:44:52

Vega100T1E1 has been running for 0 days, 00:44:56 hh:mm:ss
```

In the ISDN statistics RX slip indicates slip between the Vega and the ISDN device to which the Vega is attached. TX slip indicates slip between the internal Vega bus and the outgoing data. RX slip and TX slip indicate that the ISDN device attached to the trunk reporting the slip errors is not synchronised to the device providing the master clock to the Vega.

Statistics Cleared: Never means that ISDN statistics have never been cleared – instead of Never date / time information may be displayed.

For PRI, BRI and CAS interfaces, against the trunk is an indicator of channels in use, similar to:

```
(TE*) [X.....X.....]
```

inside the round brackets there is an indication of whether the trunk is configured as NT or TE. One of the trunks will have a \* within the brackets indicating that this trunk is "[bus master](#)". Inside the square brackets the following symbols may be found:

- X - channel reserved, either a D-channel (signalling) or a channel carrying frame synchronisation data
- . - a free media channel (B-channel)

- ? - an allocated media channel<sup>6</sup> – currently direction information is not available (transient state)
- I - an allocated media channel for an incoming call on this trunk
- O - an allocated media channel for an outgoing call on this trunk

### 9.2.5 Status Sockets

**“STATUS SOCKETS”** - provides detailed, information about the current LAN socket connections

```

Network Sockets Status:
Socket Type State Local Address Remote Address
-----
2 TCP connected 127.0.0.1:2818 127.0.0.1:998
3 TCP connected 127.0.0.1:998 127.0.0.1:2818
4 UDP connecting 136.170.208.139:2132 0.0.0.0:0
5 UDP connecting 0.0.0.0:0 0.0.0.0:0
6 TCP connecting 0.0.0.0:80 0.0.0.0:0
7 TCP connecting 136.170.208.139:1720 0.0.0.0:0
10 TCP connecting 136.170.208.139:23 0.0.0.0:0
11 UDP connecting 0.0.0.0:161 0.0.0.0:0
14 TCP connected 136.170.208.139:23 136.170.208.111:1075
Total: 9 ( Max 408 ) TCP: 6 UDP: 3

```

### 9.2.6 Show lan routes

**SHOW LAN ROUTES** displays the routing table for the Vega.

For example:

```
admin >show lan routes
```

Routing table:

Flags: U/D:Up/Down G:Gateway S/D: Static/Dynamic N/H:Network/Host x:Rejected

Destination	Gateway	Flags	Interface
172.19.1.0	172.19.1.212	U SN	LAN1
192.168.1.0	192.168.1.33	U SN	LAN2
Default	192.168.1.100	UGSN	LAN2

In this example, the first two entries show that the subnet 172.19.1.0 is accessed through LAN interface 1 (IP address 172.19.1.212) and that the subnet 192.168.1.0 is accessed through LAN interface 2 (IP address 192.168.1.33). The third entry shows that the default LANgateway (which is used for routing all data traffic which is not on one of these two subnets) is 192.168.1.100 and this is accessed via LAN interface 2.

---

<sup>6</sup> When initiating an ISDN call, Vega sends a setup with a 'suggested channel' to use in it, use of that channel is not confirmed until the Vega receives a setup ack ... which actually may request a change of channel ... but Vega reserves the channel to prevent it from being grabbed by any other call.

## 9.2.7 Show Lancfg

**"SHOW LANCFG"** - provides a summary of the LAN configurations for the various IP applications supported by the Vega.

Show lancfg takes a following identifier which specifies the information required. This is one of the following:

```
ftp
tftp
dns
ntp
all
```

Choosing an application type specifically gives more information than that displayed using 'all'.

e.g. show lancfg all

```
admin >show lancfg all
Routing table:
```

Flags: U/D:Up/Down G:Gateway S/D: Static/Dynamic N/H:Network/Host x:Rejected

Destination	Gateway	Flags	Interface
-----	-----	-----	-----
2.2.2.0	2.2.2.2	U SN	LAN1
200.100.50.0	200.100.50.22	U SN	LAN2
Default	200.100.50.79	UGSN	LAN2

FTP Configuration:

```
Server IP: 172.19.1.109
LAN profile: 2
```

TFTP Configuration:

```
Server IP: 172.19.1.109
DHCP settings from interface: 1
LAN profile: 2
```

NTP Configuration:

```
Server IP: 0.0.0.0
LAN profile: 1
```

DNS Configuration:

```
Server hierarchy:
[1]: 172.19.1.1
[2]: 172.19.1.2
```

e.g. show lan cfg ftp

```
admin >show lancfg ftp
FTP Configuration:
```

```
Server IP: 172.19.1.109
LAN profile: 2
LAN interface: 2
QoS profile: 2
Name: Voice
DiffServ/ToS: Def: 0x00 Sig: 0x00 Med: 0x00
```



## 9.2.8 Show Version

**"SHOW VERSION"** - provides firmware version, serial number / MAC address, hardware variant information and also information about the code loads in the two code partitions in the Vega.

```
admin >show version

Vega100 (T1E1) Runtime System
Version: 08.02.04b
Built: Oct 9 2002 13:38:34 T013
Serial #:005058000026

Bootstrap System
Version: 1.05(0ws)

ISDN Interface
Version: ISDN T1/E1 card: FPGA version 1, modstate 0

FLASH Partition Information:
Partition 1: H.323 Firmware
             Version: 08.01.04
             Built: Oct 9 2002 16:34:34 T011

Partition 2: SIP Firmware (ACTIVE)
             Version: 08.02.04b
             Built: Oct 9 2002 13:38:34 T013
```

The following reports give more detailed system level information:

## 9.2.9 Show Trace

**"SHOW TRACE"** - provides a detailed list of all calls in the gateway, with routing information

```
admin >show trace

CALL TRACE:

[09] call state:      AWAITING_DISCONNECT
      call ref:      070000990014
      calling party: IF 07:POTS 2[1] g711Alaw64k #TEL:07,DISP:port2vegal,NA
ME:port2vegal
      called party:  #TEL:201
      ongoing dest:  IF 99:SIP 1[1] #TEL:201,TA:192.168.1.106
      last event-7:  POTS CC_SETUP_IND, ROUTE_IDLE
      last event-6:  DSP 13878, AWAITING_DTMF_DIALING
      last event-5:  DSP 2, AWAITING_DTMF_DIALING
      last event-4:  DSP 99, AWAITING_DTMF_DIALING x5
      last event-3:  TIMR 1, AWAITING_DTMF_DIALING
      last event-2:  SIP CC_SETUPPACK_IND, AWAITING_ONGOING_CONN
      last event-1:  DSP 99, AWAITING_ONGOING_CONN
      last event :   SIP CC_DISCONNECT_IND, AWAITING_ONGOING_CONN

Summary of call states:
ROUTE_IDLE =0 AWAITING_DTMF_DIALIN=0 AWAITING_ONGOING_CON=0
AWAITING_INCOMING_CO=0 ROUTE_CONNECTED =0 AWAITING_DISCONNECT =1
AWAITING_PROGRESS_DI=0 AWAITING_MWI_SENDING=0
```

## 9.2.10 Show Stats

**"SHOW STATS"** - provides a snapshot of network statistics and memory usage

```
admin >show stats

NETWORK STATS:

RxD: inuse/max/total = 0/0/255. TxD: inuse/max/total = 0/5/254 TxB: temp/alloc/
```

Vega Admin Guide R8.5 V1.5

total = 0/0/254  
 NIC: txstat: slowf=468 fastf=960 bytes=253503  
 NIC: err=0 jit=0 unf=0 smiss=0 amiss=0 gmiss=0  
 NIC: rxstat: slowf=7784 fastf=941 bytes=777255  
 NIC: err=0 crc=0 col=0 ovf=0 cmiss=0 smiss=0 phys=0

MEDIA STATS:

Media Packets Transmitted = 2041, dropped = 0 (0.00%)  
 Media Packets Received = 941, dropped = 0 (0.00%)

MEMORY STATS:

Total RAM present: 67108864 (65536K) [0x80000000-0x84000000]  
 Code/ROM data used: 7396368 ( 7223K) [0x80040000-0x8074dc10]  
 System Memory Pool: 59449328 (58055K) [0x8074dc10-0x83fffc00]  
     System Pool available: 53055420 (51811K)  
     System Pool used: 6393908 ( 6244K) = 10% used  
 System Memory Pool Low: 258048 ( 252K) [0x80001000-0x80040000]  
     Low Memory available: 0 ( 0K)  
     Low Memory used: 258048 ( 252K) = 100% used  
 Uncached Memory Pool: 851968 ( 832K) [0x805c9db0-0x80699db0]  
     Uncached Pool available: 65360 ( 63K)  
     Uncached Pool used: 786608 ( 768K) = 92% used  
 Config Memory Pool: 700000 ( 683K) [0x806a2db0-0x8074dc10]  
     Config Pool available: 249296 ( 243K)  
     Config Pool used: 450704 ( 440K) = 64% used  
 SNMP Memory Pool: 36864 ( 36K) [0x80699db0-0x806a2db0]  
     SNMP Pool available: 4804 ( 4K)  
     SNMP Pool used: 32060 ( 31K) = 86% used

ENTITY STATS:

System idle time = 7 %

ID	Entity	In use	Max used	Hi mark	Lo mark	Capacity	Hi delay	Hi loop	Loop	%
0	INTSVC	--	--	--	--	--	--	0	0	
1	SYSTIMER	--	--	--	--	--	--	0	0	
2	CONSOLE	0	0	12	8	20	0	0	0	
3	TELNET	0	1	60	40	100	137	3	0	
4	LANPROXY	--	--	--	--	--	--	18	0	
5	LAN	0	1	90	60	150	28	13	0	
6	DSP	0	0	72	48	120	0	2	3	
7	DSPDOWN	--	--	--	--	--	--	0	0	
8	ROUTER	0	1	120	80	200	8	4	0	
9	LOGGER	0	1	30	20	50	0	3	0	
10	REDIRECT	0	0	1862	1241	3102	0	0	0	
11	LCD	0	5	30	20	50	11305	5260	10	
12	TPKT	0	0	60	40	100	0	0	0	
13	MEDIA	0	0	36	24	60	0	0	0	
14	WATCHDOG	--	--	--	--	--	--	0	0	
15	BACKGND	--	--	--	--	--	--	1646	41	
16	SNMP	0	3	12	8	20	17368	4984	43	
17	PACING	0	1	36	24	60	0	0	0	
18	WEBSERV	0	0	6	4	10	0	32	0	
19	RFC2833	--	--	--	--	--	--	0	0	
21	SIP	0	37	90	60	150	18418	183	0	
22	ISDNVDR	--	--	--	--	--	--	0	0	
23	ISDN	0	1	90	60	150	47	14	0	
24	TN	--	--	--	--	--	--	0	0	

MESSAGING STATS:

MsgID	1stKey	LastKey	Name	Size	Capacity	In use	Max used
f1000010	1001d	10028	CALL_CONTROL	436	250	0	3
f1000004	20008	20014	MC_IND	124	200	0	1
f1000007	30015	30016	MG_IND	40	200	0	0
f1000002	40002	40007	SYSTEM_CTRL	208	100	0	8
f100000f	50017	5001c	LAN_MESSAGE	64	1652	1	3
f1000001	60001	60001	TIMER_EXPIRE	52	400	0	37
f1000011	70029	70035	ISDNVDR_IND	368	100	0	2

SOCKET STATS:

Protocol In use Max used Capacity

```
TCP      4      6      272
UDP      2      3      136
SOCKETS 10     -      408

NETWORK BUFFER STATISTICS:
      in use=4      max used=33      capacity=1500

VEGA100 has been running for 0 days, 02:24:41 hh:mm:ss
```

Total number of calls: 4 [Completed: 0]

```
-----TN MEMORY STATISTICS -----
# of used blocks:      446
# of free blocks:      2
Largest block size:   2260
Smallest block size:  40
Total used space:     73740
Total free space:     254260

single unit blocks:   0
zero unit blocks:     0

zero unit blocks:     0
Tot. inspections:    120
Tot. # requests:     120
Avg. inspections:    1
Max. inspections:    1
Max memory used:     73840
```

### 9.2.11 Show Syslog

**"SHOW SYSLOG"** - shows the SYSLOG settings and status.

```
admin >show syslog
```

```
SYSLOG STATS
Server      IP              Mode              Attempts  Errors
-----
Main_Server 192.168.1.2    log | bill | console 15        0
My_PC       192.168.1.78  log | bill          8         0
Eng_laptop  192.168.1.66  debug              2         0
```

Attempts = Number of Syslog messages prepared for sending  
Errors = Number of Syslog messages that failed to be sent, e.g. because of internal resources or the configured IP address has 'no route to destination'. (Because UDP Syslog does not support handshaking, the fact that there are zero errors does not guarantee that the Syslog server has received all the messages.)

## 9.2.12 Showdsp

**"SHOWDSP"**

- shows the DSP channels' status – also the builds of DSP code loaded and their echo tail size capabilities.

In the example below a call is in progress on Channel 0.

```
admin >showdsp
```

```
Available DSP Image Builds
```

```
-----
Build: AC5; Longest Echo Tail: 64ms; Max Channels: 6/12
CODECS: G729,G729AnnexA,G711Alaw,G711Ulaw,T38,Clear
```

```
Build: AC4; Longest Echo Tail: 128ms; Max Channels: 5/5
CODECS: G729,G729AnnexA,G723.1,G711Alaw,G711Ulaw,T38,Clear
```

Ch	Status	InUse	Image	A/ULaw	Ver	PCmds	TS	Mode	Codec
00	READY	N	AC5	A	9	0	000	VOICE	G7231
01	READY	N	AC5	A	9	0	000		
02	READY	N	AC5	A	9	0	000		
03	READY	N	AC5	A	9	0	000		
04	READY	N	AC5	A	9	0	000		
05	READY	N	AC5	A	9	0	000		
06	READY	N	AC5	A	9	0	000		
07	READY	N	AC5	A	9	0	000		
08	READY	N	AC5	A	9	0	000		
09	READY	N	AC5	A	9	0	000		
0A	READY	N	AC5	A	9	0	000		
0B	READY	N	AC5	A	9	0	000		
10	READY	N	AC5	A	9	0	000		
11	READY	N	AC5	A	9	0	000		
12	READY	N	AC5	A	9	0	000		
...	etc								
69	READY	N	AC5	A	9	0	000		
6A	READY	N	AC5	A	9	0	000		
6B	READY	N	AC5	A	9	0	000		
70	READY	N	AC5	A	9	0	000		
71	READY	N	AC5	A	9	0	000		
72	READY	N	AC5	A	9	0	000		
73	READY	N	AC5	A	9	0	000		
74	READY	N	AC5	A	9	0	000		
75	READY	N	AC5	A	9	0	000		
76	READY	N	AC5	A	9	0	000		
77	READY	N	AC5	A	9	0	000		
78	READY	N	AC5	A	9	0	000		
79	READY	N	AC5	A	9	0	000		
7A	READY	N	AC5	A	9	0	000		
7B	READY	N	AC5	A	9	0	000		

The Ch column (Channel number) is one (or more) digit(s) representing the DSP core that the DSP resource is in and the last digit is the resource ID within that core. The number of resource IDs varies depending on the DSP code loaded. Max Channels indicates the number of resources the code will allow in a DSP core.

For AC5 code 6 resources are available for compression codecs, and 12 for non compressing codecs (G.711)

For AC4 (which supports a longer ech tail) 5 resources are available per DSP core whatever codec is chosen.

**9.2.13 Dspdiag**

**"DSPDIAG"** - requests detailed diagnostic statistics from a specific DSP channel

Command format:

```
DSPDIAG <function> <channel>
```

<channel> - to select the appropriate DSP channel use [SHOWDSP](#).

<function>:

- RAW - for engineering use only
- VSTATS - average delay, jitter etc. statistics
- ERROR - lost, dropped packets etc. statistics
- RXTX - packet counts
- LEVELS - show instantaneous transmit and receive power levels
- FMSTATS - for engineering use only
- FSTATS - for engineering use only
- FCSTATS - for engineering use only
- VALL - VSTATS, ERROR, RXTX and LEVELS in 1 command
- FALL - error statistics

**NOTE**

To look at voice statistics, also look at [9.4.3 QoS \(Quality of Service\) CDRs](#)

```
admin > dspdiag vstats 0

Channel 0, Diagnostics (VOICE Stats)
-----
AvDlay=    26  LostCt=         0  ReplCt=         0  RxSgCt=        101
AvJit =     3  IdleCt=       47423  DropCt=         0
ApbInc=     0  ApbDec=         0  CseCt =         0  PbuCt =         0

admin > dspdiag error 0

Channel 0, Diagnostics (ERROR Stats)
-----
LostEnhVcePkt =         0  DropEnhVcePkt =         0
InvalidHdrCt  =         0  VoiceBufOver  =         0

admin > dspdiag rxtx 0

Channel 0, Diagnostics (RXTX Stats)
-----
RxPktsPl =     94  TxPkts =     183  SilPktsTx=   47949  FrameDrop=     0
MinPktArr=    20  MaxPktArr=    40  AvPktArr =     69

admin > dspdiag levels 0

Channel 0, Diagnostics (LEVELS)
-----
RxPower = -52.0dBm, TxPower = -49.0dBm

admin > dspdiag vall 0

Channel 0, Diagnostics (VOICE Stats)
-----
AvDlay=    26  LostCt=         0  ReplCt=         0  RxSgCt=        101
```

```
AvJit =      3 IdleCt=      50967 DropCt=      0
ApbInc=      0 ApbDec=      0 CseCt =      0 PbuCt =      0
```

Channel 0, Diagnostics (ERROR Stats)

```
-----
LostEnhVcePkt =      0 DropEnhVcePkt =      0
InvalidHdrCt =      0 VoiceBufOver =      0
```

Channel 0, Diagnostics (RXTX Stats)

```
-----
RxPktsPl =      0 TxPkts =      0 SilPktsTx=      3005 FrameDrop=      0
MinPktArr=     -1 MaxPktArr=      0 AvPktArr =      69
```

Channel 0, Diagnostics (LEVELS)

```
-----
RxPower = -51.0dBm, TxPower = -48.0dBm
```

admin > dspdiag fall 0

Channel 0, Diagnostics (ERROR Stats)

```
-----
LostEnhVcePkt =      0 DropEnhVcePkt =      0
InvalidHdrCt =      0 VoiceBufOver =      0
```

**Nomenclature:**

- AvDlay = Average Delay
- LostCt = Lost Count
- ReplCt = Replay Segment Count (where multiple segments are sent in a packet e.g. g7231)
- RxSgCt = Received Segment Count (where multiple segments are sent in a packet e.g. g7231)
  
- AvJit = Average Jitter
- IdleCt = Idle Segment Counter – number of "idle segments" received (directly related to "idle packets")
- DropCt = Dropped packets count
- ApbInc = Adaptive Playout Buffer - delay increase counter
- ApbDec = Adaptive Playout Buffer - delay decrease counter
- CseCt = Counter of cell starvation events
- PbuCt = Playout Buffer Underflow Counter
  
- LostEnhVcePkt = Lost Enhanced (FRF.11) Voice packets
- DropEnhVcePkt = Dropped Enhanced (FRF.11)Voice packets
- InvalidHdrCt = Invalid Header Count
- VoiceBufOver = Voice Buffer Overflow
  
- RxPktsPl = Received Packets Played
- TxPkts = Transmitted packets
- SilPktsTx = Silence packets transmitted
- FrameDrop = Frames dropped
- MinPktArr = Min inter-packet arrival time
- MaxPktArr = Max inter-packet arrival time
- AvPktArr = Average inter-packet arrival time
  
- RxPower = Receive Power
- TxPower = Transmit Power

**9.3 Show Support**

**"SHOW SUPPORT"** - this command automatically executes a large number of "show" commands so that detailed information about the status of the Vega can be obtained from a single command.

The commands that it executes (on a SIP unit) are:

show banner	show log	show version
show ports	show plan	show lancfg
sip ua show trace	pots show trace	sipproxy show reg
sip show reg	sip show trace	show post paths
show lan routes	cadence show trace	debug tone status
show qos stats	sadvchg _advanced changes	rfc2833 show trace
readfxo all	readfxs all	status suppserv
sipproxy status	show trace	show syslog
status nat	status terms	show bill
schg changes	show highway	show stats
warnings	show calls	show hosts
show arp	highway check	show third party
status sockets	status buffers	esup
sem	hlist	show paths
showdsp	sput	license

The Show Support command is especially important to use prior to raising a technical support enquiry. A copy of the results of this command will provide the support engineer with useful details of the status and configuration of the Vega.

## 9.4 CDRs – Call Detail Records

Call detail records are available for billing and for quality of service information. Billing data may be obtained from the Vega either through the serial or telnet interfaces, or via Radius accounting records. Quality of service information is available from the serial or telnet interfaces.

### 9.4.1 CDR Billing via serial / telnet

The Billing log buffer stores call detail records that are generated on termination of each call.

A filter can be specified to either LOG only non-zero duration call records (good calls) – `BILL ON`, or all records (including those for calls which end as Busy or Number Unobtainable) – `BILL Z`. The log can be turned off by typing `BILL OFF`, and cleared by typing `BILL CLEAR`.

The log can be displayed either by enabling the display to the console (which displays the call log immediately the call terminates) using `BILL DISPLAY ON`, or display the whole log buffer by typing `SHOW BILL`. The latter displays a summary for each line of the log.

An alert threshold can be configured such that a warning event is issued at the configured buffer occupancy level (`bill_warn_threshold`).

***For further details on billing CDRs, see Information Note “IN 01 – Billing”***

#### 9.4.2 CDR Billing via Radius accounting records

Vegas can use Radius Accounting records to deliver billing CDR information.

Radius accounting records with “overloaded acct\_session\_ID” fields are used to carry the CDR data (Vegas do not use the Vendor specific attributes field). One of two data formats may be selected for the call sequence string, one which matches Cisco’s record format for easy integration into systems that already incorporate Cisco equipment, and the second a VegaStream format which matches the data provided in the telnet and serial CDR format.

CDR records are sent as calls start and stop. If the Cisco format is chosen, separate records are sent for each leg of the call (i.e. for a call through a Vega there will be a start and a stop record for the call as it enters the Vega and also for the call as it exits the Vega – two start records and 2 stop records).

The Vega can be configured with up to 2 Radius servers, which it uses in Master / Backup order. On power up or reboot, if any radius billing server is enabled in the Vega parameters it will send an Accounting On record (registration message) to the first enabled server. If a server fails (replies timeout) the Vega will try registering with the other server (if it is enabled). If it receives a response to the registration it will send the CDR records to this server (Accounting start and Accounting stop messages). If no reply is received it will keep hunting for a server.

The Radius Accounting Records are sent as UDP datagrams.



The following parameters are used to configure Radius on the Vega:

```
[logger.radius]
    format=cisco_overload      ; Select desired format of Radius Accounting
                                record, vega_overload or
                                cisco_compatible_overload

    retries=4                  ; Max retries used to send a specific accounting
                                message, 1 to 100

    retry_time=5000           ; Initial timeout before retry (milliseconds), 1 to
                                5000 (time doubles for each retry but limits
                                at max_retry_time)

    max_retry_time=4000       ; Maximum retry timer for retransmissions
                                (milliseconds), 1 to 40000

    window_size=10            ; Maximum number of accounting messages that can be
                                sent to the server before receiving a response, 1
                                to 256

    name=Vega_VoIP_Gtaeway    ; NAS (Network Access Server - gateway) identifier

[logger.radius.server.1]
    enable=0                  ; Disable or enable use of this radius server, 0 or
                                1

    ipname=0.0.0.0            ; IP address or DNS resolvable name of the radius
                                server

    port=1813                 ; UDP port used to receive radius data on the
                                server, 1 to 65535

    secret=Testing123         ; Shared secret encryption string - must be
                                configured on the radius server too, length <= 31
                                characters

[logger.radius.server.2]
    ...
```

***For further details on Radius accounting CDRs, see Information note “IN 07 – Radius Accounting”***

### 9.4.3 QoS (Quality of Service) CDRs

From Release 6, per-call and per-gateway logs of QoS statistics may be obtained. Like CDR billing records, the Vega has an internal buffer into which it writes the last n per-call QoS CDRs. By connecting to the Vega via telnet or via a serial connection, these can be collected live as they are generated.

***For details on configuring the Vega and the format of the resulting QOS CDR records, see information note “IN 15 QOS Statistics”***

## 10 CONFIGURATION FOR E1T1 AND BRI VEGAS

### 10.1 System Variants

Vega 400s are equipped with E1T1 links, Vega 50 Euopas are equipped with BRI links.

The parameters for configuring the above products are largely the same. These parameters that are common across all signalling schemes are documented in the following section. Specific configuration for ISDN, QSIG, and RBS CAS are documented in successive sections.

### 10.2 General Configuration For E1T1 AND BRI Vegas

#### 10.2.1 Network Type, Topology and Line Encoding

The Network type and Line Encoding values available are dependent on the Topology being used (E1, T1, or BRI), and are set in the following parameters:

```
[e1t1/bri]
network=ETSI|NI|ATT|DMS|QSIG|DMS_M1|RBS
topology=S|E1|T1
line_encoding=B8ZS|AMI|HDB3|AZI
framing=ESF|SF|CRC4|PCM30
```

Specific configuration for the different network types are handled in their own specific sections:

```
network= ETSI|NI|ATT|DMS|DMS_M1 are handled in section 10.3 "ISDN Specific Configuration",
network=QSIG is handled in section 10.4 " QSIG Specific Configuration", and
network=RBS is handled in section 10.6 "CAS T1 Specific Configuration".
```

#### 10.2.2 Companding Type

The companding or PCM-type type used on the E1T1/BRI for your specific country/switch type is configured in:

```
[e1t1/bri.port.n]
lyr1=g711Alaw64k | g711ulaw64k
```

A-law is typically used in Europe, and u-law is used in the USA.

### 10.2.3 B-channel Grouping

The ISDN port interfaces can be configured to support logical B-channel clustering if required – using the groups facility. This facility effectively assigns a unique interface ID (IF:) to a single B-channel or group of B-channels. This means that each physical ISDN can be split into a number of different interface IDs (IF:s) to specify from the dial planner which B-channel (or B-channel group) to use when making the outgoing call; also the appropriate IF: will be presented to the dial planner when a call arrives from a specific B-channel. B channel grouping can have overlapping channels, and this can, for example, be used to extend the number of DNs (directory numbers) allocated to a physical ISDN (for outgoing calls).

```
[e1t1/bri.port.n.group.m]
  interface=01
  cost=9
  dn=5551000
  first_chan=1
  last_chan=30
```

By default each E1T1/BRI has only one interface ID or group assigned to it; this covers all available B-channels, i.e. for E1 Vegas last\_chan=30, for T1 PRI Vegas last\_chan=23 and for T1 CAS Vegas last\_chan=24.

For example, to set up an interface ID, IF:35, which will send calls on channels 3 to 5, and will present a caller ID 1234567 use the following:

```
[e1t1/bri.port.n.group.m]
  interface=35
  cost=0
  dn=1234567
  first_chan=3
  last_chan=5
```

**NOTE**

Interface Ids must be unique within a single Vega. Make sure that as you create a new group you assign it a new and unique interface ID.

### 10.2.4 B-channel Allocation Strategies

In order to minimise the number of times at which the two ends of a ISDN LINK clash by choosing the same channel to try and present a call on, the channel allocation strategy can be configured on the Vega.

- Linear up mode (selecting the lowest free channel on the ISDN) – this should be selected if the far end is configured for linear down
- Linear down mode (selecting the highest free channel on the ISDN) – this should be selected if the far end is configured for linear up
- Round Robin mode (selecting the next free channel on the ISDN 1..last\_chan then back to 1 again) – this should be selected if the far end is configured for round robin
- Default – for easy configuration this will use linear up if the ISDN is configured as NT, and Linear down if the ISDN is configured as TE.

```
[elt1/bri.port.n.group.m]
  alloc_chan=default|linear_up|linear_down|round_robin
```

### 10.2.5 Inband progress tones

See section [13.6.3, Selecting Generation of Progress Tones vs Media Pass Through](#).

### 10.2.6 Cause code mapping

When ISDN, RBS CAS, H.323 and SIP calls are cleared down a “cause code” is generated which identifies the reason for the call clear-down – a list of clear-down cause codes may be found in Information Note IN 18. Typically if a call clears for a particular reason the Vega will pass that reason code on as the reason for clearing. There are however times at which the Vega may need to modify the cause code value it sends on. For instance if the Vega bridges two networks, where one network supports a smaller set of clear-down cause codes than the other, the Vega will have to map outlying cause codes onto valid cause codes.

The Vega can apply a cause code mapping to cause codes sent out over the (ISDN or RBS CAS) telephony interfaces. Cause code mapping tables are configurable through the web browser using the advanced>show\_cause\_mapping menu or via the CLI parameters

```
[_advanced.outgoing_cause_mapping.x]
  name = <name>      ; name parameter for self documentation purposes
  c1=1                ; mapping for cause code 1 (by default = 1)
  c2=2                ; mapping for cause code 2 (by default = 2) ... etc.
  ...
  c127=127
```

From Release 7.5, the Vega can also apply a cause code mapping to cause codes received from the (ISDN or RBS CAS) telephony interfaces. Cause code mapping tables are configurable through the web browser using the advanced>show\_cause\_mapping menu or via the CLI parameters:

```
[_advanced.incoming_cause_mapping.x]
  name = <name>      ; name parameter for self documentation purposes
  c1=1                ; mapping for cause code 1 (by default = 1)
  c2=2                ; mapping for cause code 2 (by default = 2) ... etc.
  ...
  c127=127
```

Cause code mappings are set up by altering the cause code parameters away from the 1:1 relationship (c1=1, c2=2 ... etc.) which is the default configuration. If a call comes in with a clear-down cause code of 2, for instance, then the Vega will look up parameter c2 and will pass on the value that has been assigned to it as the clear-down cause code.

Each ISDN interface can be configured to map or not to map cause codes using:

```
[elt1/bri.port.n.isdn]
  incoming_cause_mapping_index=x ;incoming mapping table to use
  outgoing_cause_mapping_index=x ;outgoing mapping table to use
```

`x` defines the `_advanced.cause_mapping.x` mapping table to use. If `x = 0` then no mapping is performed.

The mapping table to use for each ISDN interface may be configured through the web browser using:

```
e1t1/bri>Port Configuration "Modify"> e1t1/bri_configuration >ISDN Configuration>
cause_mapping
```

### 10.2.7 Bus master

The `bus_master_priority` configuration parameter defines which trunk the Vega uses to synchronise its internal clock.

The Vega receives a clock on ports configured as `clock_master = 0` (Vega 400) and as `nt=0` (Vega 50 BRI). The `bus_master_priority` parameter should be configured to prioritise the clock receiver trunks in the order that they should be used for synchronising the Vega internal clock.

*For further details on configuring bus master, see Information Note "IN 03 – ISDN Clocks"*

### 10.2.8 Vega 400 Bypass Relays

*For more information on this feature refer to Information Note "IN 44 – Vega 400 Bypass Relays"*

Some models of Vega 400 are fitted with fallback relays such that in the event of power failure or intervention by maintenance personnel the E1T1 connections become metallically connected to a second set of RJ45 connectors.

The diagram below shows a typical install where the fallback relays could be in use:

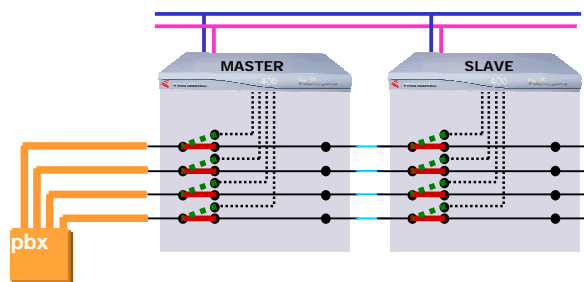

The status of the ISDN fallback relays can determine whether SIP registration takes place on a Vega 400 (models where ISDN fallback relays are fitted).

The slave Vega can be configured such that it will only transmit SIP REGISTER messages when its DSL's become active. This would happen if the master Vega loses power, is upgraded or is manually put into bypass mode.

Parameter:

```
sip.reg_mode
```

Possible values:

```
normal - Default - Existing behaviour, Vega will register any
configured SIP users
```

```
on_ISDN_active - Vega will only register users when any DSL is active
```

## 10.2.9 Specific T1 configuration

### 10.2.9.1 T1 Line matching

For the Vega T1 product the transmit equalisation for the ISDN trunks needs to be configured. This is achieved on a per trunk basis using:

```
[e1t1/bri.port.x]
    t1_tx_equalization=<tx_equ>
```

<tx\_equ> can take the following values:

lh1bo0	(long haul line build out 0 dB)	
lh1bo7_5	(long haul line build out -7.5 dB)	
lh1bo15	(long haul line build out -15 dB)	
lh1bo22_5	(long haul line build out -22.5 dB)	
sh0_110	(short haul 0-110 ft.)	
sh110_220	(short haul 110-220 ft.)	
sh220_330	(short haul 220-330 ft.)	- default setting
sh330_440	(short haul 330-440 ft.)	
sh440_550	(short haul 440-550 ft.)	
sh550_660	(short haul 550-660 ft.)	

Long haul values are used where the distance between the Vega and the closest repeater or other ISDN endpoint is greater than 660 feet. Short haul value lengths are the distance between the Vega and the closest repeater or other ISDN endpoint.

NOTE
------

The `t1_tx_equalization` setting is only applicable in T1 mode (`topology=t1`); in E1 mode `t1_tx_equalization` is ignored.

E1 systems have their own equalization setting `e1_rx_short_haul`

### 10.2.9.1.1 Guidelines for configuring `t1_tx_equalization`:

For short haul the aim is to make sure that the shape of the waveform at the receiver is as perfect as possible; changing the parameter alters the shape of the waveform generated by the Vega (to compensate for the additional capacitance of longer lines). Match the parameter value to the line lengths indicated in the above table. If the length is not known, then start using the value `sh220_330`.

For long haul (> 660 feet) the waveshape is not altered any further; the configuration parameter affects the amplitude of the signal. The aim is to tune the transmit amplitude such that the receiver receives a signal slightly above -36dB below the maximum signal strength (the 0dBm value). If the transmitted amplitude is too high, cross-talk can be introduced onto other lines, if too low it will not be reliably detected. If it is not possible to measure the received amplitude then it is best to start by setting the value to `lh1b00`.

## 10.2.10 Specific E1 configuration

### 10.2.10.1 E1 Line matching

For the Vega E1 product the receiver sensitivity needs to be configured based on the line length between the Vega and the closest repeater or other ISDN endpoint.

The configuration is achieved using:

```
[elt1/bri.port.n]
```

```
e1_rx_short_haul=0 or 1 ; 0=long haul and 1=short haul
```

Long haul should be selected when the cable between the Vega and the closest repeater or other ISDN endpoint introduces more than 6dB attenuation.

Short haul should be selected when the cable between the Vega and the closest repeater or other ISDN endpoint introduces less than or equal 6dB attenuation.

## 10.3 ISDN Specific Configuration

### 10.3.1 Introduction

ISDN signalling is a CCS (Common Channel Signalling) scheme, which means that it uses messages in the 'D' channel to signal call states. With a message based structure, many useful indicators can be passed, including information like DDI, DNIS, Answer and Disconnect.

### 10.3.2 ISDN Network Type, Topology and Line Encoding

The following table can be used as a guide when setting up parameters for ISDN installations:

Product	Physical Connection	Topology	Network	E1T1/BRIs	Line Encoding	Framing	Calls
Vega 400 E1:	E1-2.044 Mbps	E1	Euro ISDN	4	HDB3	CRC4 / PCM30	8 to 120
T1:	T1-1.544 Mbps	T1	NI2, AT&T 5ESS, DMS, DMS_M1	4	B8ZS / AMI	SF(=D4) / ESF	8 to 92
Vega 50 Europa	S/T 384 Kbps	S	Euro ISDN	2, 4 or 8	AZI	-	4, 8 or 16

#### 10.3.2.1 DMS-Meridian-specific ISDN setting (SIP builds only)

The `elt1/bri.network` configuration parameter has been extended to include `dms_m1`. This is the selection required when connecting a SIP Vega 400 to a Meridian PABX.

The protocol implemented for this selection is identical to DMS100 (`network=dms`) with the one exception:

*The final Channel Number Octet of the Channel ID Information Element is set to a '0' and not '1'.*

#### 10.3.3 NT/TE Configuration

Each ISDN physical interface or E1T1/BRI (digital subscriber line) can be software configured to be either the TE (Terminal Equipment) or NT (Network Termination) end. This enables the Vega to be used in multiple scenarios, i.e. trunks plugged into a CO (Vega trunks configured as TE), trunks plugged into a PBX (the Vega acting as though it were a CO - Vega trunks configured as NT), or with one trunk plugged into the CO and one into a PBX. The latter scenario allows the Vega to be inserted into an existing telephony link between a CO and PBX and based on dial plan rules, it can either continue to pass calls between the PBX and the CO, or groom off some of the calls and route them on as VoIP calls.

When configuring TE and NT, the value of the `clock_master` parameter should also be checked. Usually, if NT is set, then `clock_master` should also be set, and if NT is clear (TE mode) then the Vega should be a clock slave (`clock_master=0`).



The pinouts for TE and NT connections are different. On the Vega 400 the hardware pinouts change as TE or NT are selected. In this case a straight cable can in general be used to connect to the far end device.

### 10.3.4 Specific BRI configuration

#### NOTE

1. Do not be surprised if, even after configuration, the LCD call count remains at “-” and the Trunk LED flashes indicating no layer 2 connection. Many BRI connections do not bring up layer 2 until a call is made.
2. Vega 50 BRI units all have 100 ohm termination impedances across their LINKSs. Ideally the Vega should be connected physically at the end of the LINKS.

#### 10.3.4.1 BRI Point-to-Point Mode

Basic Rate ISDN lines (S0 bus interfaces) can be configured in one of two ways, either Point-to-Point or Point-to-Multipoint.

Point-to-Point (PP) is used

- i when a Vega is connected to a BRI CO network line which is configured to support just one device connected directly to it (the Vega will be configured as TE) – e.g. ISDN data line connection.
- ii when a Vega is the only device connected directly to a BRI PBX and is acting like a CO network (the Vega will be configured as NT).

Point-to-Multipoint (PMP) is used

- i when a Vega is connected as the NT device connected to one or more ISDN telephones or other TE endpoints.
- ii when a Vega is connected as an attached device to an S0 bus interface on a PBX or BRI CO network where ISDN telephones would normally be plugged

#### NOTE

Devices that are connected together on a single BRI S0 bus must either:

- all be configured as Point-to-Point or must
- all be configured as Point-to-Multipoint.

The default mode of operation for the BRI product is to use Point-to-Multipoint mode (PMP) on all ports.

Each PORT of the Vega 50 BRI can be independently configured to use either Point-to-Point mode (PP) or Point-to-Multipoint mode (PMP) whether the PORT is configured as TE or NT.

In PP mode a maximum of one device at a time can be connected to each PORT. A fixed Terminal Endpoint Identifier (TEI) must be defined for the Vega PORT, and this must match the one configured in the corresponding device (typically configure TEI=0). Either the same or different TEIs may be defined for each physical PORT.

The configuration parameters to set up a fixed TEI to 'xx' on PORT 'n' are as follows:

```
[bri.port.n]
line_type=pp
te=xx
```

To revert the BRI back to Point-to-Multipoint mode (PMP) configure the parameter as follows:

```
[bri.port.n]
line_type=pmp
```

(In pmp mode the value of `tei` is ignored.)

#### 10.3.4.2 BRI TE – Telephone number to accept

In a Point-to-Multipoint configuration the NT device may be connected to multiple TE devices. When a call arrives the NT device broadcasts the details of the call (including the called number) to the TE devices. Any TE device that is configured to accept calls for that number will start ringing. When a TE device answers the call, it locks out the other TE devices from this call and a 1:1 connection is made between the NT and the answered TE for the rest of the call.

If a Vega is one of the TE endpoints, then the parameter that configures which called number(s) it will respond to is:

```
[bri.port.x.group.y]
dn
```

If the value of `dn` matches the last digits of the called number then the Vega will try to handle the call (it will use its dial plan to onward route the call).

By default `dn=*`, and so the Vega will respond to every call that is sent from the NT.

Example:

If `...1.group.1.dn=34` then the Vega will respond to calls on BRI 1 to:

- 01344 784 934, and
- 020 1234 34, etc.

but will not respond to:

- 01344 784 933, or
- 020 1234 35.

`dn` may take the value of `*`, or may be a sequence of digits.

#### 10.3.4.3 BRI Layer 2 handling

In most signalling scenarios it is required that signalling layers come up in order and that if a layer fails, all layers are cleared down before being restarted. With certain BRI system implementations however, the network is configured to drop L2 when not in use (but not layer 1) – layer 2 is then re-established when a call is to be made. In this case it is valid to allow layer 2 to be re-established without layer 1 going down then up.

Vega 50 BRI units may be configured to only start layer 2 after layer 1 has just come up, or allow layer 2 to be re-established at any time after a layer 2 disconnect. The parameter is:

```
[_advanced.isdn]
restart_l2_after_disc=1 / 0
```

If set to 1 (default) the Vega 50 BRI allows re-establishment of layer 2 after a layer 2 disconnect has occurred.

If set to zero then establishment of layer 2 is only attempted if layer 1 has just come up.

### 10.3.5 Verifying ISDN IEs (Information Elements)

The ISDN stack in the Vega verifies that IEs found in the signalling match the relevant signalling specification. It verifies both the IE types, and also their content.

Where the signalling does not completely adhere to the appropriate specification the Vega can be configured to disable this checking:

```
set _advanced.isdn.verify_IEs=0           disables checking of IE types (and contents
                                           of those IEs)
set _advanced.isdn.verify_IE_contents=0   disables checking of contents of IEs
```

See also section [10.5 "Tunnelling signalling data"](#) for details on passing extra signalling information through the Vega.

### 10.3.6 Call Hold

When configured as NT, BRI gateways will respond to received ISDN HOLD or SUSPEND messages and will place the other call party on hold. The call will be taken off hold on reception of a RETRIEVE or RESUME message. Whilst the call is on hold the tone defined by `tones.suspended_seq` will be played to the on-hold party.

## 10.4 QSIG Specific Configuration

### 10.4.1 Introduction

QSIG is a CCS (Common Channel Signalling) protocol similar to ISDN, though more tailored to PBX to PBX communications, supporting supplementary services that enable PBXs to pass information between themselves. Many of the same features and parameters used in configuring ISDN signalling are also used for configuring QSIG.

QSIG is supported on E1/T1 equipped Vegas, SIP Vegas support QSIG Basic Call handling; H.323 Vegas support both QSIG Basic Call handling and QSIG tunnelling.

By enabling QSIG Basic Call handling, this allows the Vega to operate at the Q-reference point to any Basic Call compliant device (PINX). In this mode the Vega can only send and receive the subset of Q.931 call control messages defined in the QSIG Basic Call Specification (ISO/IEC 11572).

From details on H.323, QSIG tunnelling, see [10.5 Tunnelling signalling data](#)

[QSIG Tunneling.](#)

### 10.4.2 QSIG Network Type, Topology and Line Encoding

The following table can be used as a guide when setting up parameters for QSIG installations:

Product	Physical Connection	Topology	Network	E1/T1s	Line Encoding	Framing	Calls
Vega 400-PRI E1:	E1-2.044 Mbps	E1	QSIG	4	HDB3	CRC4 / PCM30	8 to 120
T1	T1-1.544 Mbps	T1	QSIG	4	B8ZS/AMI	SF/ESF	8 to 92

### 10.4.2.1 E1 QSIG Operation

The following parameters are used to configure the interface:

```
[e1t1]
  topology=E1
  network=qsig
  line_encoding=hdb3
  framing=crc4/pcm30

[_advanced.isdn]
  qsig_mode=contiguous/non_contiguous
```

#### 10.4.2.1.1 E1 QSIG, Contiguous / Non-Contiguous Channel Mapping

QSIG User Channels (Uqs) can be numbered in two ways:

- i) in a contiguous block, Uqs = 1..30 (Uq channels 1-15 map on to Timeslots 1..15, and Uq channels 16..30 map onto Timeslots 17-31).
- ii) In a non-contiguous block, Uqs = 1..15 and 17..31 (Uq channels 1-15 map directly on to Timeslots 1..15, and Uq channels 17..31 map directly onto Timeslots 17-31).

The numbering scheme (`qsig_mode`) configured on the Vega must match the scheme used by the QSIG device that the Vega is connected to.

### 10.4.2.2 T1 QSIG Operation

The following parameters are used to configure the interface:

```
[e1t1]
  topology=T1
  network=qsig
  line_encoding=b8zs/ami
  framing=esf/sf
```

#### 10.4.2.2.1 T1 QSIG, Contiguous / Non-Contiguous Channel Mapping

Unlike E1, there is no similar concept of contiguous / non-contiguous mapping of QSIG user channels (Uqs).

For T1 Uqs always form a contiguous block, which maps directly onto the timeslots. (Uq channels 1..23 map onto Timeslots 1..23).

### 10.4.3 NT/TE or Master/Slave Configuration

Each E1T1 (digital subscriber line) can be software configured to be either QSIG master (A-side) or QSIG slave (B-side). The `nt` configuration parameter is used to select the appropriate setting. The Vega E1T1 should always be configured to be the opposite value to that configured on the attached QSIG device. (i.e. if attached QSIG device is Master, Vega must be set to slave).

```
[elt1.port.n]
    nt=1                ; QSIG, master or "A" side
```

```
[elt1.port.n]
    nt=0                ; QSIG, slave or "B" side
```

NOTE
------

In Vega statistics A-side is indicated as NT and B-side is indicated as TE.

When configuring A-side and B-side, the value of the `clock_master` parameter should also be checked.

On the Vega 400 the hardware pinouts change as TE or NT are selected. In this case a straight cable in general can be used to connect to the far end device.

#### 10.4.4 Overlap Dialling

See paragraph in [Error! Reference source not found. "Error! Reference source not found."](#).

#### 10.4.5 Type of Number configuration

Type of Number is configured as described in section [8.11 National / International Dialling – Type Of Number](#), but as the configuration was implemented for ISDN rather than QSIG, ISDN names need to be used when configuring QSIG PNP TON values. When configured for QSIG signalling the following mapping occurs:

Required QSIG PNP TON	Binary Code	Configuration value needed (ISDN TON)
Unknown	0 0 0	Unknown
Level 2 Regional Number	0 0 1	International Number
Level 1 Regional Number	0 1 0	National Number
PISN specific number	0 1 1	Network-specific number
Level 0 Regional Number	1 0 0	Subscriber Number

#### 10.4.6 Message Waiting Indication

The Vega can now pass MWI (message waiting indication) as follows:

- SIP to QSIG (i.e. from a SIP IP voicemail system to legacy PBX)
- QSIG to SIP (i.e. from legacy PBX to SIP)

Both support for standard and Ericsson proprietary message format has been added.

The following parameters are relevant for message waiting delivery:

Parameter:

`_advanced.isdn.mwi.type`

Possible values:

normal - Default - Use standard message format for MWI  
ericsson - Use Ericsson proprietary message format

Parameter:

`_advanced.isdn.mwi.ericsson.ASF_IE_ID`

Possible values:

Default 127 - Any value between 0 and 255

Parameter:

`_advanced.isdn.mwi.ericsson.PBX_Protocol_ID`

Possible values:

Default 254 - Any value between 0 and 255

Parameter:

`_advanced.isdn.mwi.ericsson.system_ID`

Possible values:

Default 0 - Any value between 0 and 99

#### 10.4.7 QSIG Un-Tromboning

Un-Tromboning, also known as TBCT (Two Bearer Channel Call Transfer), or call optimisation is now supported on Vega 400s running SIP firmware. Where a call has been established through the Vega then subsequently transferred or forwarded, the situation can exist where a trombone (or hairpin) exists between the Vega and PBX such that two bearer channels are taken up by a single call.

The following scenarios are supported:

- Vega initiated un-tromboning, see diagram below. Un-tromboning initiated by the Vega on QSIG so that the call is directly connected by the PBX.
- PBX initiated un-tromboning, see diagram below. Un-tromboning initiated by the PBX, resulting in the transmission of SIP REFER message so that two IP endpoints are directly connected..

Both support for standard and Ericsson proprietary message format are supported.

#### Vega Initiated Un-Tromboning

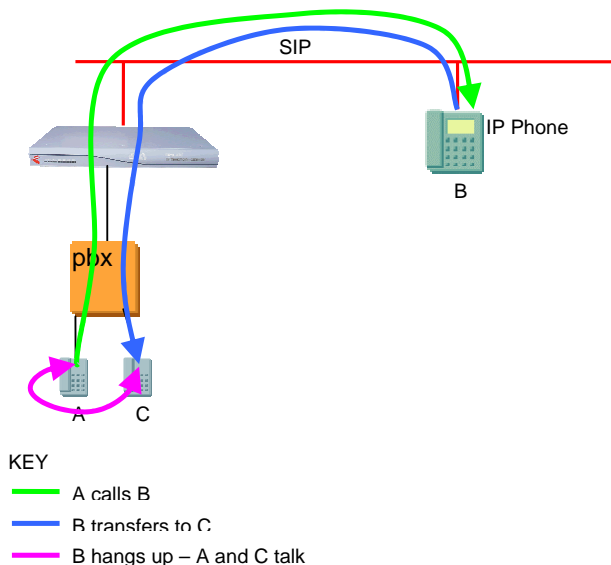

The Vega's default behaviour relies on detecting that two SIP call legs have the same call ID in order to initiate the QSIG side un-tromboning. Other headers can be checked and verified using the following parameters:

Parameter:

`._advanced.sip.loopback_detection.sip_header`

Possible Values:

String up to 31 characters - Default "NULL". This is the header to look for to check for a SIP loopback call

Parameter:

`._advanced.sip.loopback_detection.sip_header_regex`

Possible Values:

String up to 127 characters - Default "NULL". Format is in the form of a regular expression - the user must use < and > delimiters to find the unique component within the SIP header.

The flexible approach of specifying a regular expression was chosen as it allows other loopbacks to be detected when interacting with other third party devices.

### Example Using non-Call ID Detection

In this example the following SIP header is sent to the Vega:

```
TWID: TW-CALL-SERVER-00000108-48d11387:-T2
```

It's this header rather than the Call ID header which needs to be used to detect a SIP loopback. In this case the Call ID is different for the two legs of the call (so cannot be used for detection).

To detect the "TWID" header the following settings would be used:

```
set ._advanced.sip.loopback_detection.sip_header="TWID"
set ._advanced.sip.loopback_detection.sip_header_regex="<TW\-CALL\-SERVER\-.*>:.*"
```

In this case the Vega will look for two calls where the TWID header has the same content. Everything from the start of the TWID header up to (but not including) the ":-T2". The position of the "<" and ">" indicate the section the vega will use for comparison.

## PBX Initiated Un-Tromboning

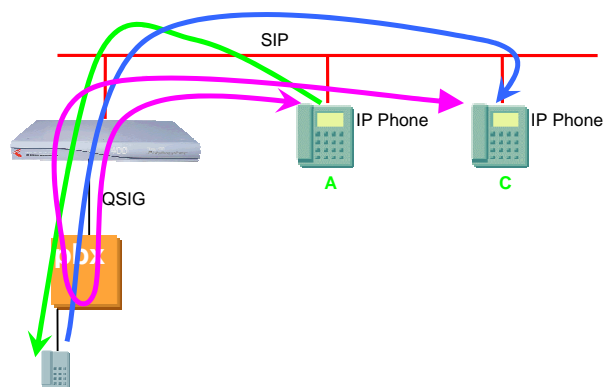

### KEY

- A calls B
- B transfers to C
- B hangs up – A and C talk

### 10.4.7.1 Configuration

The following parameters control Un-Tromboning:

#### Parameter

```
elt1.port.1.isdn.untromboning_enable
```

#### Possible values:

- 0 - Default - Do not allow un-tromboning
- 1 - Enable un-tromboning

#### Parameter:

```
_advanced.isdn.untromboning.type
```

#### Possible values:

- standard - Default - Use standard message format for un-tromboning
- ericsson - Use Ericsson proprietary message format

#### Parameter:

```
_advanced.sip.loopback_detection
```

#### Possible values:

- 0 - Default - Disable SIP loop detection
- 1 - Enable loop detection for SIP calls

## 10.5 Tunnelling signalling data

### 10.5.1 QSIG Tunneling (H323 Only)

QSIG is often used to connect PBXs together where advanced features, like camp-on-busy on another PBX are required. Traditionally leased TDM lines (T1 or E1) would be used to directly connect each PBX to each and every other PBX (a fully meshed network).

As TDM leased lines are expensive people are looking to use VoIP instead.



QSIG tunnelling is a special mode of Vega operation whereby instead of interpreting each signalling setup and clear-down message and converting it to an H.323 call setup or clear-down, the Vega tunnels all D-channel (signalling) messages to their appropriate destinations. This means that not only call setups and clear-downs can be passed across the VoIP link, but so can other messages, such as those that allow un-tromboning of calls, those that allow camp-on-busy and those that allow the message-waiting-indicator to be illuminated on a phone attached to a different PBX. In this way all inter-PBX communication functionality is preserved, whereas in standard H.323 VoIP the advanced features would be lost.

Another major benefit of the VegaStream implementation of QSIG tunnelling (that follows ECMA 333) is that instead of requiring 1 E1 or 1 T1 trunk between each and every other PBX in the network, the meshing can be carried out on a per-channel basis across the IP network. Each PBX has one Vega (or more ... dependent only on the simultaneous call requirement) attached to their QSIG interface(s). For each and every signalling message the Vega will route the message to the appropriate destination.

QSIG tunnelling is configured on a per-trunk (e1t1) basis; to enable QSIG tunnelling, firstly configure the trunk for QSIG signalling, then set the following parameter to `on_demand`:

```
[elt1.port.n.group.m]
  tunnel_mode=on_demand ; set it to "off" to disable tunneling.
```

For QSIG tunnelling, the dial plan needs to be configured to route calls from the telephony interface(s) to the appropriate IP address of the far end gateway – any of the usual Tokens, like TEL: can be used in the `srce` statement to select the appropriate destination IP address.

**NOTE**

In QSIG tunnelling mode, because the QSIG signalling messages are tunneled through the Vegas (and not translated to H.323), the dial plans are just used to select the destination interface and where appropriate the destination IP address. Trying to change for instance the TEL: or TELC: in the dial plan will not work in QSIG tunnelling mode because the Vega does not change the content of the messages.

For calls from the LAN interface, the dial planner just needs to select the appropriate QSIG trunk to which to route the call.

**NOTE**

With the VegaStream implementation, as well as tunnelling QSIG messages, in `on_demand` tunnelling mode the Vega will tunnel any Q.931 messages.

See table in section [10.5.3 "Tunnelling full signalling messages and IEs in ISDN \(ETSI, ATT, DMS, DMS-M1, NI, VN 3/4\) and QSIG"](#) for details of interactions of various parameters with `tunnel_mode`.

### 10.5.2 Tunnelling Non-QSIG Signaling Messages (H323 Only)

As QSIG is a relatively modern signaling scheme, although some manufacturers claim their PBX to PBX protocol to be QSIG, and although most of it is, some inter-PBX messages remain proprietary. Vegas can be configured to support this too, but because of their proprietary nature, the Vega cannot decode each and every proprietary message. The Vega is therefore limited to tunneling these proprietary messages on a point-to-point basis.

Proprietary messages still support a standard header which identifies the protocol being used in the message. The Vega looks at the protocol ID and uses this to decide how to route the message – Vegas can route different protocols to different destinations.

The routing is carried out by the dial planner, but the details to present to the dial planner are configured in a set of parameters as follows:

```
[_advanced.dsl.port.X.tunnel_protocol.Y]
cpn=off / called_party_number_string
```

where **x** is the DSL port on which the proprietary message is arriving and **y** is the protocol ID+1 (plus 1 so that protocol ID 0 can be handled)

When a message arrives the Vega looks at the protocol ID. If it is 8 (Q.931) then it will tunnel it fully – this is QSIG/Q.931. If it is other than ID 8, then it will use the ID+1 to index into [\_advanced.dsl.port.X.tunnel\_protocol.Y]

If there is no entry, or `cpn=off`, then the message will be discarded.

If `cpn=called_party_number_string` then this `called_party_number_string` will be presented to the dial planner to obtain the routing information (IP address of the destination). The `called_party_number_string` can consist of TEL: and TELC: tokens.



### WARNING!

Where call SETUP messages are in proprietary messages, the Vega cannot decode them, and so does not know to open a B channel (media channel), so although the messaging may work no audio connection will be made.

For this reason, do not include `y=9` (Protocol ID=8 – Q.931 / QSIG) in the set of [\_advanced.dsl.port.X.tunnel\_protocol.Y] as this will make the Vega treat this as a proprietary protocol and so it will not interpret the SETUP message and so will not open a media channel when required.

Protocol Ids and **y** values:

Protocol ID	Y	Comments
0	1	User-specific protocol
1	2	OSI high layer protocols
2	3	X.244
3	4	Reserved for system management convergence function
4	5	IA5 characters
5	6	X.208 and X.209 coded user information
7	8	Rec. V.120 rate adaption
8	9	Q.931/I.451 user-network call control messages
16 thru 63		Reserved for other network layer or layer 3 protocols, including Recommendation X.25
64 thru 79		National use
80 thru 254		Reserved for other network layer or layer 3 protocols, including Recommendation X.25
Other values		Reserved

See table in section [10.5.3 “Tunnelling full signalling messages and IEs in ISDN \(ETSI, ATT, DMS, DMS-M1, NI, VN 3/4\) and QSIG”](#) for details of interactions of various parameters with `tunnel_mode`.

### 10.5.3 Tunnelling full signalling messages and IEs in ISDN (ETSI, ATT, DMS, DMS-M1, NI, VN 3/4) and QSIG

When passing calls from ISDN to ISDN, ISDN to / from H.323 and ISDN to / from SIP, by default Vega gateways tokenise certain IEs (Information Elements) from the incoming signalling messages and re-generate the outgoing messages from those tokens. This allows the dial planner and other Vega configuration parameters to modify the values, e.g. Calling Party Number, Called Party Number, Display, and Bearer Capability.

Where signaling messages or specific IEs need to be passed through, the Vega can be configured to accommodate this. This table applies to PRI and BRI signaling schemes.

	eltl/bri.port.x.gr oup.y.tunnel_mode	eltl/bri.port.x.gr oup.y.tunnel_IEs_o nly	_advanced.isdn. IEs_to_tunnel	Action
ISDN to ISDN	Off	-	-	<b>No tunnelling</b>
	on_demand	0	-	ISDN to ISDN full message tunnelling is not supported
		1 N.B. Enable this parameter on both source AND destination trunks	Comma separated list of IEs to tunnel	<b>Tunnel listed IEs</b>
ISDN to H.323  and  H.323 to ISDN	Off	-	-	<b>No tunnelling</b>
	on_demand	0	-	<b>ISDN / QSIG tunnelled over H.323</b>
		1	-	ISDN tunneling of IEs not supported over H.323
ISDN to SIP  and  SIP to ISDN	off			<b>No tunnelling</b>
	on_demand	0	-	ISDN tunneling over SIP not supported
		1 N.B. Enable this parameter on both source AND destination gateways	Comma separated list of IEs to tunnel	<b>Tunnel listed IEs</b>

Example IE ids:

08 = cause  
1c = facility  
1e = progress indicator  
20 = network specific facilities  
24 = terminal capabilities  
28 = display  
29 = date and time  
2c = keypad facility  
34 = signal  
40 = information rate  
6d = calling party subaddress  
71 = called party subaddress

78 = transit network selection  
 7c = Low Layer Compatibility  
 7d = High Layer Compatibility  
 7e = User to User Information  
 96 = shift

See section [10.3.5 “Verifying ISDN IEs \(Information Elements\)”](#) for details on how to stop the Vega complaining about unusual Information Elements in messages.

The IEs can be tunnelled across SIP either using X-UII headers or using a special content type ‘application/vnd.cirpack.isdn-ext’. This is selectable using the `_advanced.sip.q931.tx_tun_mode` parameter.

Setting `_advanced.sip.q931.tx_tun_mode` to `reg_uri` uses X-UII headers in SIP messages to transport the tunnelled IEs. The preferred solution is to set `_advanced.sip.q931.tx_tun_mode` to `cirpack`, which causes the Vega to pass data using a content type: ‘application/vnd.cirpack.isdn-ext’.

## 10.6 CAS T1 Specific Configuration

T1 Vegas support T1 CAS (Robbed Bit Signalling) operation. In this mode each T1 trunk supports up to 24 simultaneous calls. The specific varieties of CAS RBS supported are:

- E&M Wink Start
- E&M Wink Start with feature group D
- FXS Loop Start
- FXS Ground Start

The variety of CAS signalling to be used can be specified on a per-dsl basis. In band DTMF or MF tone signalling is used to pass dialling information such as B-party number (DNIS), and where supported A-party number (ANI).

### 10.6.1 RBS CAS Network Type, Topology, Signal type and Line Encoding

The following table can be used as a guide when setting up parameters for QSIG installations:

Product	Physical Connection	Topology	Network	Signal	E1T1s	Line Encoding	Framing	Calls
Vega 400-T1	T1-1.544 Mbps	T1	RBS	em_wink, loopstart, gndstart, fgd	4	B8ZS/AMI	SF/ESF	8 to 96

#### 10.6.1.1 RBS CAS Operation

The following parameters need to be configured for CAS operation

```
[e1t1]
network=rbs           ; selects CAS RBS operation
framing=auto         ; or esf or sf
line_encoding=auto   ; or b8zs or ami
```

```

[elt1.port.n.cas]
  signal=em_wink           ; or loopstart, gndstart, or fgd (em_wink with
                          ; feature group D)
  dial_format=.           ; see configuring dial\_format below for details
  rx_dial_format=.        ; see configuring dial\_format below for details
  tx_dial_format=.        ; see configuring dial\_format below for details
  digit_dial_timeout=6    ; Time after last dialled digit is received that DNIS / ANI
                          ; are treated as complete – 1-1000 seconds
  info=dtmf               ; DTMF or MF
  tone_delay=50           ; delay after ack wink that first tone is sent, 1-1000 ms

[elt1.port.1.group.m]
  first_chan=1
  last_chan=auto          ; Check that this is auto or 24

[elt1.port.2.group.m]
  first_chan=1
  last_chan=auto          ; Check that this is auto or 24

```

## NOTE

- Some CAS schemes (e.g. E&M wink start) do not have a “called party alerting” message – call progress tones (ringing, busy etc.) are passed in the media channel. For the calling party to hear these, a media path must be established well before the connect is received – i.e. early media must be supported and used on the VoIP side, e.g. for the Vega either configure:
  - early H.245, or
  - fast start with `accept_fast_start=3`
- For ground start and loop start signalling the Vega only supports the TE/Slave side of the signalling protocol.

### 10.6.2 Configuring dial\_format

ANI and DNIS are presented as in-band tones (DTMF or MF tones), separated by specified delimiter tones. The `elt1.port.x.cas.dial_format` parameter, now superceded by `elt1.port.x.cas.rx_dial_format` (for incoming calls) and `elt1.port.x.cas.tx_dial_format` (for outgoing calls) allows the format of the reception and presentation of the ANI and DNIS to be specified.

o = ANI (Caller's telephone number)

n = DNIS (Called party number / Dialed number)

DTMF can use the separator characters: 0-9, A-D, \*, #, ~

MF can use the separator characters: 0-9, K, S, ~

where ~ indicates no character expected, K = MF KP tone, and S = MF ST tone.

e.g. `*o#*n#` indicates the sequence \*, ANI digits, #, \*, DNIS digits, #

By default

```

[elt1.port.x.cas]
  dial_format=.

```

```
rx_dial_format=.
tx_dial_format=.
```

this configures the vega to automatically select an entry from the following table based on its signalling configuration:

	DTMF	MF
E&M wink, groundstart, loopstart	*n#	KnS
Fgd (e&M winkstart with feature group D)	*o#*n#	KoSKnS

NOTE
------

The durations of the DTMF and MF signalling tones (and inter-tone silence) is specified by `dtmf_cadence_on_time` and `dtmf_cadence_off_time`. You may wish to reduce the default values of these parameters to around 70ms to 100ms each to speed up the signalling interchange.

### 10.6.3 NT/TE Configuration

E&M signalling, including feature group D is a symmetric signalling scheme, so there is no need for NT/TE configuration. With loopstart and ground start signalling, which are non-symmetric, the Vega only supports the TE side of the signalling, so again, the NT/TE is not configurable.

The value of the `clock_master` parameter does still need to be set up and should be configured as 1 if the device to which the vega is attached is not sourcing the clock, and should be set to 0 if the other end is supplying the clock.

For Vega 400 the pinout is changed internally depending on the Nt/TE setting, so in general a straight through cable can be used to connect to the far end device..

***Further details of the Vega and cable pinouts may be found in the Product Details section of the [www.VegaAssist.com](http://www.VegaAssist.com) web site.***

## 10.7 CAS E1 Specific Configuration

### 10.7.1 E1 CAS R2MFC

The only form of CAS signalling that the Vega gateways support is R2 MFC, a compelled tone based CAS signalling.

***Details on how to configure the Vega for R2MFC signalling may be found in the Information Note "Configuring R2MFC" available from the [www.VegaAssist.com](http://www.VegaAssist.com) web site.***

## 11 POTS CONFIGURATION

Unlike digital systems which can be configured as either NeTwork side or Terminal Equipment side through software configuration, the hardware required to implement analogue interfaces is different depending on whether the gateway is to connect to telephones or whether the gateway is to connect as though it were a set of telephones. The two types of analogue interface are known as FXS (Subscriber / Phone facing – like lines from the PSTN or extension port interfaces on a PBX) and FXO (Office / Network facing – like a bank of telephones).

Therefore, with analogue gateways the type and number of analogue ports must be specified when ordering the product as it is **not** user configurable.

### 11.1 FXS Supplementary Services

A number of supplementary services are supported, these are:

- Call Transfer
- Three Way Call (3 Party Conference)
- Call Forward
- Do Not Disturb (DND)
- Call Waiting

#### 11.1.1 Call Transfer

See IN27 – FXS Call Transfer, available on [www.vegaassist.com](http://www.vegaassist.com) for details on this feature.

### 11.1.2 Three Way Calling

When two calls are connected to an FXS port it is now possible to configure the gateway to allow for the three calls to be connected (conference call). This feature is only available for SIP firmware builds.

Depending on the configuration, the three-way call can be initiated by the FXS user using 'command mode' (a sequence of digits are dialed to initiate the three-way connection) or using 'simple mode' (a number of 'hook-flashes' are performed to initiate the three-way connection).

The three way call can be initiated using two different call flow scenarios:

- Call Transfer
- Call Waiting

#### Sample Network Diagram

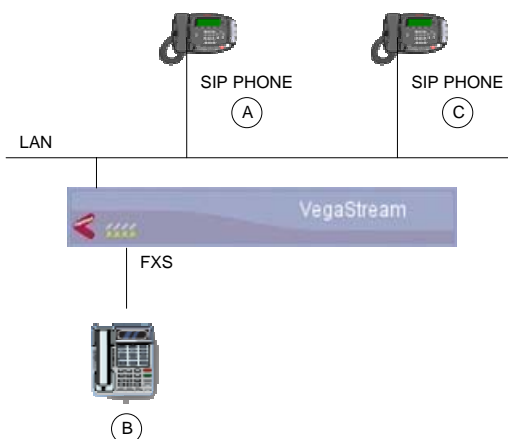

#### 11.1.2.1 Command Mode / Call Transfer Three Way Call

- A (SIP Phone) calls B (Analogue Phone connected to FXS port)
- A connects to B
- B performs a hookflash, dials C (SIP Phone)
- B connects to C
- B can perform further hookflashes to toggle between A and C
- B enters command mode string (by default this is \*54)
- A, B & C enter Three Way Call

#### 11.1.2.2 Command Mode / Call Waiting Three Way Call

- A (SIP Phone) calls B (Analogue Phone connected to FXS port)
- A connects to B
- C calls B (B hears Call Waiting 'beep')
- B performs a hookflash and connects to C
- B can perform further hookflashes to toggle between A and C
- B enters command mode string (by default this is \*54)
- A, B & C enter Three Way Call



### 11.1.2.3 Simple Mode / Call Transfer Three Way Call

- A (SIP Phone) calls B (Analogue Phone connected to FXS port)
- A connects to B
- B performs a hookflash, dials C (SIP Phone)
- B connects to C
- B performs a further hookflash
- A, B & C enter Three Way Call

In Simple Mode the following number of hookflashes result in the following call connections:

- First hookflash = talk to 1st caller
- Second hookflash = talk to 2nd caller
- Third hookflash = conference
- Fourth hookflash as first hookflash

### 11.1.2.4 Simple Mode / Call Waiting Three Way Call

Call Waiting Three Way Call initiation is not supported when the Conference mode is 'Simple'.

### 11.1.2.5 Three Way Call Indications

- When switching to talk to the 1<sup>st</sup> caller the FXS user should hear a single short beep just before being connected.
- When switching to talk to the 2<sup>nd</sup> caller the FXS user should hear two short beeps just before being connected.
- When switching to talk in conference mode the FXS user should hear a single long beep just before being connected.

### 11.1.2.6 Configuration

All Supplementary Service configuration can be performed via the Web User Interface (WUI). The following parameters are accessible via the Command Line Interface (CLI).

Overall activation of Supplementary Services is enabled using the following parameter:

```
suppserv.enable
```

Where the parameter value can be :

- 0 = Disable supplementary services.
- 1 = Enable supplementary services (default setting).

The call conference mode is defined by the following parameter:

```
suppserv.profile.1.call_conference_mode
```

Where the parameter value can be:

- `cmd_mode` = Use command mode (dialled digit command) to initiate conference call.
- `simple` = Use 'simple mode' (hookflashes) to initiate conference call.

The call conference command is defined by the following parameter:

```
suppserv.profile.1.code_call_conference
```

Where the parameter value can be:

- A string of between 1 and 9 characters (these characters must be 'diallable' digits).  
The default string is \*54

### 11.1.3 Call Forwarding

Call forwarding can optionally be enabled for FXS ports. Three variants are available:

- Call Forward No-Answer (CFNA)
- Call Forward Busy (CFB)
- Call Forward Unconditional (CFU)

Call forwarding can be programmed using the handset or via CLI commands. Optionally call forwarding statuses can be saved and restored to a server.

When a call is forwarded the dial plans are used in order to try to route the call.

When call forwarding is enabled, when going off-hook, the POTS user will hear 3 short dial tone bursts, followed by a short pause, followed by the normal dial tone (or stutter dial tone).

#### 11.1.3.1 Operation Examples

(Assuming default configuration, as below)

To set Call Forward Always with destination 555:

1. lift handset on POTS port
2. dial \*72 555 #

This means that all calls for POTS port 1 will get forwarded to tel number 555.

To disable Call Forward Always:

1. lift handset on POTS port
2. dial \*73

To enable Call Forward Always without altering call forward destination

1. lift handset on POTS port
2. dial \*72 #

N.B. Call forward destinations are the same for all call forwarding.

i.e. you can't have different call forward destinations for different types of call forwarding.

### 11.1.3.2 Parameters

Configuring DTMF codes for call forward enable / disable:

suppserv.profile.1.code\_cfb\_on      Default \*90

suppserv.profile.1.code\_cfb\_off      Default \*91

suppserv.profile.1.code\_cfna\_on      Default \*92

suppserv.profile.1.code\_cfna\_off      Default \*93

suppserv.profile.1.code\_cfu\_on      Default \*72

suppserv.profile.1.code\_cfu\_off      Default \*73

suppserv.profile.1.code\_disable\_all      Default \*00

(for all of these, default is as above but will allow any 9 character string)

### 11.1.3.3 Enabling call forward:

Parameter added:

    pots.port.x.call\_fwd\_enable

Possible values:

    on - Default - Allow specified port to activate call fwd

    off - Do not allow call forward on specified port

Parameter added:

    \_advanced.pots.save\_pots\_user\_status

Possible values:

    off - Default - Do not save status to server

ftp - Save status to FTP server

#### 11.1.3.4 CLI Commands - Call Forwarding Control

```

fxs cf dest - USAGE: fxs cf dest <port> <call fwd dest or NULL>
fxs cfu      - USAGE: fxs cfu <port> <on/off>
fxs cfb      - USAGE: fxs cfb <port> <on/off>
fxs cfna     - USAGE: fxs cfna <port> <on/off>

```

##### Examples:

```
admin >fxs cf dest 1 555
```

port 1, set call forward destination to 555

```
admin >fxs cfu 1 on
```

port 1, enabled call forward unconditional

```
admin >fxs cfu 1 off
```

port 1, disabled call forward unconditional

```
admin >fxs cf dest 1 NULL
```

port 1, clear call forward destination

#### 11.1.3.5 CLI Commands - Call Forward Status Using "show ports"

To query call forward status:

```
admin >show ports
```

Physical ports:

Name	Type	Status
POTS-1	POTS (FXS)	on-hook ready (cfu,dest=555)
POTS-2	POTS (FXS)	on-hook ready

This shows that a call forward unconditional has been set with destination 555.

### 11.1.3.6 Call Forward Status - Preservation After Reboot

Config Variable:

```
_advanced.pots.save_pots_user_status=off or ftp  
default is "off"
```

If set to "ftp", then "call forward" and "do not disturb" status will be attempted to be stored to the configured FTP server.

Then on a reboot, the file will be read from the FTP server.

The filename will take the format XXXXXXXXXXXXXfsstatY.txt

where:

XXXXXXXXXXXX is the 12 character serial number of the unit

Y is a number representing the FXS port number

For example: 005058020604fsstat2.txt

```
_advanced.pots.save_pots_user_status=off or ftp  
default is "off"
```

If set to "ftp", then "call forward" and "do not disturb" status will be attempted to be stored to the configured FTP server.

#### 11.1.4 Do Not Disturb

Do Not Disturb (DND) can optionally be enabled for FXS ports. DND can be programmed using the handset or via CLI commands. Optionally call forwarding statuses can be saved and restored to a server.

When call forwarding is enabled, when going off-hook, the POTS user will hear 3 short dial tone bursts, followed by a short pause, followed by the normal dial tone (or stutter dial tone).

The Vega can be configured to either send a busy message or ringing indication back to the calling party.

##### 11.1.4.1 Operation Examples

(Assuming default configuration, as below)

To set Call Forward Always with destination 555:

1. lift handset on POTS port
2. dial \*78

This means that all calls for POTS port 1 will get forwarded to tel number 555.

To disable Call Forward Always:

1. lift handset on POTS port
2. dial \*79

##### 11.1.4.2 Configuration Parameters

`suppserv.profile.x.code_dnd_on` Default \*78

`suppserv.profile.x.code_dnd_off` Default \*79

(for all of these, default is as above but will allow any 9 character string)

Parameter added:

`pots.port.x.dnd_enable`

Possible Values:

- on - Default - Allow DND to be activated for specified port
- off - DND cannot be activated for specified port

Parameter added:

`pots.port.x.dnd_off_hook_deactivate`

Possible Values:

- on - Going off-hook immediately cancels DND

off - Default - Going off-hook does not cancel DND

Parameter added:

pots.port.x.dnd\_response

Possible Values:

instant\_reject - Default - Instant\_reject call with SIP 480 or SIP message as defined by do\_not\_disturb.status\_code

spoof\_ringing - Send ringing back to call originator

Parameter added:

\_advanced.sip.do\_not\_disturb.status\_code

Possible Values:

400-699 - Default 480 - SIP status code to use for DND

Parameter added:

\_advanced.sip.do\_not\_disturb.status\_text

Possible Values:

String up to 47 characters, default "Do Not Disturb"

### 11.1.4.3 CLI Commands - DND Control

fxs dnd - USAGE: fxs dnd <port> <on/off>

Example:

```
admin >fxs dnd 1
```

port 1, enabled do not disturb

### 11.1.4.4 CLI Commands - DND Status Using "show ports"

To query DND status:

```
admin >show ports
Physical ports:
Name      Type  Status
-----
POTS-1    POTS  (FXS) on-hook ready (dnd)
```

If DND has been activated, the "(dnd)" text will be present



#### 11.1.4.5 DND Status - Preservation After Reboot

See entry under “Call Forward” for details.

#### 11.1.5 Call Waiting

When a call is placed into an FXS port that already has an active call the Vega (if configured) plays a call waiting indication tone to the FXS port and sends a SIP 180 or 183 message to the new caller to indicate ringing. Optionally the Vega can now be configured to send a SIP 182 – Queued – message so that the caller is aware of the status of the call.

Parameter:

```
_advanced.sip.call_waiting.status_code
```

Possible values:

```
off - Default - Use SIP 180 / 183 as normal
182 - Use SIP 182 Queued for call waiting call
```

See “IN38 – FXS Call Waiting” for more information on this feature.

## 11.2 POTS Phone Facing (FXS) ports

FXS ports on a Vega gateways are designed to connect to conventional, loop start POTS telephony products such as telephones and faxes; also to connect to analogue trunk interfaces of PBXs. Operation of the interface involves the following activities:

### 11.2.1 DTMF digit detection

DTMF Digits are detected automatically by the Vega and no parameters are necessary to configure this operation.

### 11.2.2 Hook Flash detection

The maximum period of time for detecting a line break as a hookflash (as opposed to on-hook) is configured in

```
[_advanced.pots.fxs.x]
hookflash_time
```

Typically, values of between 100ms and 800ms are appropriate.

If the call clears when hookflash is being detected, then increase the value of `hookflash_time`.

Also see:

```
[_advanced.pots.fxs.x]
hookflash_debounce_time
```

### 11.2.3 Ring Cadence Generation

Each POTS port can generate a number of different (or distinctive) outgoing ring patterns. A different ring pattern can be referenced (`ring_index`) for each different “group” section created for the FXS POTS port concerned. The ring cadence generator uses the `ring_index` to select a particular ring pattern as defined in `_advanced.pots.ring.x`.

E.g. The following parameters would be used to configure the Vega such that whenever an outgoing call is presented to FXS interface 33 the ring pattern is defined by the first entry in the ring cadence table:

```
[pots.port.n.if.m]
  ring_index=1
  interface=33

[_advanced.pots.ring.1]
  frequency=50
  name=Internal-UK
... etc.
```

## 11.2.4 Line supervision – Answer and disconnect

### Loop Current disconnect

FXS ports on Vega gateways can be configured to provide a Loop Current Disconnect signal on their FXS ports when calls clear down on the LAN side. To configure Loop Current Disconnect generation on FXS ports, use the following parameters:

```
[_advanced.pots.fxs.1]
  loop_current_break
  loop_current_delay
  loop_current_time
```

`loop_current_break` is the overall enable / disable flag, `loop_current_time` is the time that the loop current will be broken for (make sure that this is slightly longer than the attached devices' detection period). `loop_current_delay` is a configurable delay after the other party has cleared that the Vega waits before issuing the loop current disconnect; this gives the FXS party a chance to clear the call before the loop current disconnect is issued.

#### NOTE

Whilst the loop current disconnect is being issued, there is no line voltage / current to detect, and so no other POTS events can be detected, for example, on-hook and off-hook events can not be detected until completion of the loop current disconnect.

### Line Current Reversal

FXS ports may be configured to reverse the line voltage on the POTS interface on call answer and call disconnect. To enable this function set:

```
[_advanced.pots.fxs.x]
  line_reversal=1
```



#### WARNING!

If the Vega is configured to operate using line current reversal then the device which is attached to the Vega must also support this functionality as answer and clear down are indicated using the line current reversals.

### 11.2.5 DTMF digits after answer

Vega FXS ports can be configured to send DTMF digits after answer in order to further route the call on the connected device.

This feature is controlled by the TEL: token in the destination dial plan entry; if a dial plan entry that routes calls to an FXS port has a TEL: token containing some digits, when the FXS port is taken off-hook the DTMF will be played out.

e.g.. if the following dial plan routes the call:

```
srce=IF:99.. ,TEL:<501>    dest=IF:0101,TEL:<1>
```

the Vega will play out the digits 501 immediately after the call is answered on port FXS 1.

## 11.3 POTS Network Facing (FXO) ports

FXO ports on a Vega gateways are designed to connect to an analogue CO switch or analogue extension ports on a PBX.

### 11.3.1 Line voltage detection

Before an outbound call is made Vega FXO ports check that there is line voltage on the line. If no line voltage is observed (less than +/- 5volts) the call is rejected with cause code 27; this can be checked for in the dial planner / call presentation group and used to represent the call to another destination which is active.

### 11.3.2 Impedance configuration

The impedance of the FXO ports is configurable from the user interface (both web browser and CLI). Three choices of impedance are selectable:

1. 600R (US style)
2. CTR21 (European style)
3. 900R

NOTE
------

Although in practice the Vega will operate when the impedance is set incorrectly, for approvals reasons it is important that you configure the FXO port to the impedance utilised by the country in which the Vega is installed. For example:

600R	CTR21
Canada, Caribbean, Central America, China, Hong Kong, Malaysia, Mexico, Saudi Arabia, South America, Taiwan, Thailand, United Arab Emirates, United States	Austria, Belgium, Cyprus, Denmark, Finland, France, Germany, Greece, Iceland, Ireland, Israel, Italy, Liechtenstein, Luxembourg, Netherlands, Norway, Portugal, Spain, Sweden, Switzerland, United Kingdom

FXO port impedance is configured in the FXO Port Hardware Configuration Profile parameters:

```
[_advanced.pots.fxo.y]
    impedance
```

On the web browser, change it in the **FXO Parameters** section of the POTS > Advanced POTS > FXO Configuration > Hardware Profile Configuration (Modify)

Ensure that the hardware profile associated with the port has the correct impedance set. The hardware profile selection for each FXO port is made in:

```
[pots.port.x]
  fx_profile
```

Set `fx_profile=y`

On the web browser, this is found in the **Modify Port** section of the POTS > Port Configuration (Modify)

### 11.3.3 DTMF digit generation

The DTMF on/off times, initial holdoff between off-hook and dialling, and DTMF tone amplitude are all user configurable:

```
[_advanced.pots.fxo.x]
  dtmf_holdoff_time=200
```

```
[_advanced.dsp]
  dtmf_gain=10000    - being superceeded by dtmf hi / lo gain
  dtmf_hi_gain
  dtmf_lo_gain
  dtmf_cadence_on_time=150
  dtmf_cadence_off_time=250
```

It is strongly recommended that the values of `dtmf_hi_gain` and `dtmf_lo_gain` are not altered; changing these value from default may cause the Vega to produce out-of-spec DTMF tones

### 11.3.4 Hook Flash generation

The time period for generating the hookflash (on-hook) pulse is configured in

```
[_advanced.pots.fxo.x]
  hookflash_time
```

Typically a value of around 500ms is appropriate.

### 11.3.5 Ring Cadence Detection

FXO ports on a Vega gateway are only capable of detecting a single incoming ring pattern. The following parameters are used to configure the cadence detection circuit for a particular ring:

```
[_advanced.pots.fxo.x]
  ring_detect_longest_ring_off=5000
  ring_detect_shortest_ring_on=250
```

Examples:

Parameter	UK	USA
Longest silence	2000ms	4000ms
Shortest ring	400ms	2000ms

### 11.3.6 Line Supervision – Answer and Disconnect

Vega FXO ports operate in one of three modes for line supervision.

- 1) No Supervision  
**Disconnect Supervision:** In this mode the Vega FXO port is unaware of the on-hook/off-hook state of the far end during a call. The responsibility for tearing down a call lies with the VoIP side of the call, regardless of which end established the call. Usually the VoIP subscriber will hear the other party hang up followed by call progress tones indicating that the far end caller has disconnected; they will then hang up the call in response.  
**Answer Supervision:** When an outgoing call is attempted over the FXO interface the Vega will connect and answer the incoming VoIP call at the same time as dialling out on the POTS line. If billing is carried out based on the VoIP messaging, callers will be charged for outdialling and any following success or failure messages – there is no answer signal available to be passed through the Vega.
  
- 2) Loop Current Detection:  
**Disconnect Supervision:** In this mode the Vega FXO port detects the short break in loop current which the PBX / CO switch generates (to indicate that the far end party has terminated the call) and it will clear the call through itself.  
**Answer Supervision:** This method does not indicate that the far end has answered the call. When an outgoing call is attempted over an FXO interface the Vega will connect and answer the incoming VoIP call at the same time as dialing out on the POTS line. If billing is carried out based on the VoIP messaging, callers will be charged for outdialling and any following success or failure messages – there is no answer signal available to be passed through the Vega.

Loop Current disconnect detection is enabled by setting:

```
[_advanced.pots.fxo.x]
  loop_current_detect=loop_current_disconnect_time
```

The *loop\_current\_disconnect\_time* value should be configured to be slightly shorter than the period for which the PBX / switch makes the break in loop current.

**NOTE**

The *loop\_current\_detect* time **MUST** be greater than *hook\_flash\_time*, otherwise a hook flash will cause the call to clear down.

- 3) Line Reversal Detection:  
**Disconnect and Answer Supervision:** In this mode the FXO port detects the polarity of the line to determine if the far end has answered the call and also uses it to sense if the far end has terminated the call. When an outgoing call is attempted over the FXO interface the Vega will only connect the incoming VoIP side if the far end answers (indicated by the line current being reversed to its 'active' state).

Call clear-down is indicated by the line current being reversed back to its 'idle' state. If line reversal is supported by the CO Switch/PBX then it allows the Vega to answer the call when the destination call is answered and the Vega to clear the call when the destination call is cleared. If billing is being carried out on the VoIP messaging then the caller will correctly only be billed for the voice connected part of the call.

It is enabled by setting:

```
[_advanced.pots.fxo.x]
  line_reversal_detect =1
```

Other parameters associated with line current reversal are:

```
[_advanced.pots.fxo.x]
line_reversal_sample_delay=<time>
line_reversal_debounce_time=<debounce time>
```

**WARNING!**

**If line\_reversal is enabled on a Vega FXO port but is not supported by the PBX / switch that it is connected to, then outgoing FXO calls will never be answered (as there will never be a line reversal)**

If possible either loop current detection or line reversal should be used to ensure calls are cleared from FXO ports in a timely manner. However only one method of supervision should be enabled at a time – enabling them both is likely to stop the Vega handling calls correctly.

### 11.3.7 Tone Detection

The method of tone detection configuration described in this section is available on Vega 50 Europas. Vega 5000s use a different method, described in “IN36 – Configuring Ans\_n\_Disc Supervision” available at [www.vegaassist.com](http://www.vegaassist.com).

If no other means of reliable disconnection signalling are available (i.e. battery line reversal or loop current disconnection signalling) and progress tones are provided (i.e. busy, congestion and disconnection indications) a Vega gateway can be configured to detect disconnection tones which are received on an FXO port.

It is useful to think of an FXO interface / port as an analogue handset when considering call supervision.

For an inbound call, as ringing voltage is received into an FXO interface, the port will go 'off-hook'. Depending on the dial plan configuration the inbound call maybe routed immediately to a destination interface or secondary dial tone may be played to the calling party (who is making the calling 'into' the FXO port).

For an outbound call, as a call is routed (via the dial plan) to the FXO interface, the port goes 'off-hook' and plays DTMF tones to the exchange / pbx (i.e. the called number is dialled). At this point of the call the calling leg of the call will automatically be connected, i.e. if the calling party is SIP a 200 OK is sent immediately to the calling party.

Once the inbound (or outbound) call is terminated by the PSTN / PBX party (or the call fails to establish as the destination is busy or congested), disconnection tones are played towards the FXO interface. If configured to do so, the FXO interface will detect these tones and the FXO port will go 'on-hook' ready for another call.

#### 11.3.7.1 Configuration

Firstly, if tone detection is going to be used as the method for call disconnection ensure that all other disconnection methods are disabled. The following parameters values disable all other disconnection methods:

```
_advanced.pots.fxo.1.line_reversal_detect=0
_advanced.pots.fxo.1.loop_current_detect=0
_advanced.pots.fxo.1.voice_detect=0
```

The following parameters determine the FXO interface tone disconnection configuration (and activation):

```
_advanced.pots.fxo.x.tonedetect
```

Where 'x' represents the FXO profile in use by a specific port. Possible values are:  
0 (default) - disconnection tone detection is disabled.

1 - disconnection tone detection is enabled.

Busy, Congestion and Disconnection tones can (each optionally) be detected by configuring the following parameter set values:

```
tonedetect.x.y.enable
tonedetect.x.y.freq1
tonedetect.x.y.freq2
tonedetect.x.y.freq3
tonedetect.x.y.off_time1
tonedetect.x.y.off_time2
tonedetect.x.y.off_time3
tonedetect.x.y.on_time1
tonedetect.x.y.on_time2
tonedetect.x.y.on_time3
```

Where:

x = busy, congestion or disconnect

y = profile index - i.e. if two different busy tones need to be detected a profile can be created for each type of tone detection, i.e. `tonedetect.busy.1` and `tonedetect.busy.2` etc.

In the majority of cases only one profile needs to be configured for each disconnection tone type (busy, congestion, disconnection).

```
tonedetect.x.y.enable
```

Possible values are 0 or 1 - i.e. disable or enable the detection of the tone defined in this tone detection profile.

```
tonedetect.x.y.freq1
tonedetect.x.y.freq2
tonedetect.x.y.freq3
```

Possible values are 250 - 700, which represents a frequency (in Hz) present in the tone defined in this tone detection profile. If the tone is single frequency the values of `freq2` and `freq3` should be set to 0 - i.e. no detection.

```
tonedetect.x.y.off_time1
tonedetect.x.y.off_time2
tonedetect.x.y.off_time3
```

Possible values are 0 to 10,000, which represents the off time (in Milliseconds) of the cadence of the tone to be detected. Tones which contain multiple cadences can be detected by configuring differing `off_time` values (i.e. `off_time2` and `off_time3`). Unless the tone does contain multiple cadences `off_time2` and `off_time3` should be set to 0 - i.e. no multi-cadence detection.

```
tonedetect.x.y.on_time1
tonedetect.x.y.on_time2
tonedetect.x.y.on_time3
```

Possible values are 100 to 10,000, which represents the on time (in Milliseconds) of the cadence of the tone to be detected. Tones which contain multiple cadences can be detected by configuring differing `on_time` values (i.e. `on_time2` and `on_time3`). Unless the tone does contain multiple cadences `on_time2` and `on_time3` should be set to 0 - i.e. no multi-cadence detection.

### 11.3.7.2 Detecting Tones

There are a number of commands that can be used to display the tones that are received at the Vega FXO port. The output of these commands can be used to correctly configure the parameters described above.

To display the frequencies and cadences that are being received the following commands can be issued:

```
debug on
debug tone enable
```

When the `debug tone enable` command is issued the Vega is no longer able to detect tones and thus disconnect calls. i.e. It's not possible to both debug and detect tones.

See below for sample output from the above commands.

To stop the debug output:  
`debug tone disable`

To query the status of the commands:  
`debug tone status`

### Sample Output

```
_DSP      :Trace : 0145465: 07315:DSP      :user-defined tone detected digit 412Hz,0Hz (digit 3)
:(dspac.c;1036)
_DSP      :Trace : 0145835: 00370:DSP      :user-defined tone is now off :(dspac.c;914)
_DSP      :Trace : 0146215: 00380:DSP      :user-defined tone detected digit 412Hz,0Hz (digit 3)
:(dspac.c;1036)
_DSP      :Trace : 0146595: 00380:DSP      :user-defined tone is now off :(dspac.c;914)
_DSP      :Trace : 0146970: 00375:DSP      :user-defined tone detected digit 412Hz,0Hz (digit 3)
:(dspac.c;1036)
_DSP      :Trace : 0147350: 00380:DSP      :user-defined tone is now off :(dspac.c;914)
_DSP      :Trace : 0147730: 00380:DSP      :user-defined tone detected digit 412Hz,0Hz (digit 3)
:(dspac.c;1036)
_DSP      :Trace : 0148110: 00380:DSP      :user-defined tone is now off :(dspac.c;914)
```

From the sample output above it can be seen that the detected frequency was 412Hz and the cadence is 370ms on-time (145835 – 145465) and 380ms off-time(146215 – 145835)

### 11.3.8 FXO – Slow network clear-down

In certain networks, for instance Mobile networks it takes a long time for the Network to clear. If a new call is made immediately after a previous one clears, the call will fail. In order to accommodate this, the Vega can be configured to prevent new calls to FXO ports until a specified period has passed since the previous call cleared. To configure this, use parameters:

```
[_advanced.pots.fxo.x]
    port_notreleased_cause
    port_release_delay
```

If a call is attempted within the `port_release_delay` period after the previous call cleared, then the Vega will reject the call with cause code `port_notreleased_cause`. This can be used to try and re-present the call using call re-presentation.

### 11.3.9 FXO – Secondary dial tone

Usually an FXO interface will immediately route a call as soon as it detects ring tone.

If the dial plan specifies a TEL: token in the dial plan for an FXO port, when a call arrives at that port, rather than routing the call immediately, dial tone will be played to the caller. The caller can then enter digits using DTMF tones (phone key presses), and the digits received will provide digits for the TEL: token comparison in the dial planner. Calls can now be routed using TEL:, as well as TELC:, IF: etc.

The time that dial tone is played for (and before the call is routed assuming NO digits are entered) is defined by:

```
[pots.profile.2]
    dtmf_dial_timeout=5
```

(this is the inter digit DTMF timeout). If the timeout is set to 0 then the call will be routed immediately (effectively turning off the secondary dial tone feature).



## 11.4 Analogue Caller-ID (CLID)

Analogue Vega gateways support caller ID by receiving / generating FSK or DTMF tones during the ringing phase of a call.

Vega FXS ports generate the tones towards the attached telephones, and FXO ports detect the tones when they are sent by the attached PBX / CO switch.

Several types of CLID encoding are supported on the Vega units; the appropriate mechanism can be configured by setting the parameter:

```
[pots]
    callerid_type=gr30-sdmf / gr30-mdmf / bt / etsi-fsk / etsi-fsk-lr
    / etsi-fsk-post / etsi-dtmf / etsi-dtmf-lr / etsi-dtmf-post / off
```

### **gr30-sdmf**

Conforms to Bellcore standard GR30 - single data message format. Just passes the call time and number information. The latest standard mentions that this format may be dropped in future.

### **gr30-mdmf**

Conforms to Bellcore standard GR30 - multiple data message format. This passes the caller name as well as the call time and number. (This configuration will also receive gr30-sdmf caller Ids)

### **bt**

Based on the gr30-mdmf format but with a difference in the tones and interface to the POTS as required for use in the UK. The specification requires the phone to send a whetting pulse after the first tones are detected.

### **etsi-fsk**

Use ETSI FSK, delivered before ring.

### **etsi-fsk-lr**

Use ETSI FSK, delivered before ring but after line reverse.

### **etsi-fsk-post**

Use ETSI FSK, delivered between 1<sup>st</sup> and 2<sup>nd</sup> ring.

### **etsi-dtmf**

Use DTMF, delivered before ring.

### **etsi-dtmf-lr**

Use DTMF, delivered before ring but after line reverse.

### **etsi-dtmf-post**

Use DTMF, delivered between 1<sup>st</sup> and 2<sup>nd</sup> ring.

### **off**

Turns off Caller ID handling.

The parameter

```
[pots.port.n]
    callerid
```

controls Caller ID on a port by port basis; it can take the values off or on.

#### 11.4.1 FXS – Outbound Analogue Caller ID (CLID) – H.323 and SIP

Caller ID generation can be enabled and disabled on a per port basis using

```
[pots.port.n]
  callerid=on/off.
```

The particular line encoding type used must be set up in:

```
[pots]
  callerid_type= caller Id type
```

Caller ID is sent out both at the start of a call and, if the call waiting supplementary service is enabled, when a 2<sup>nd</sup> call arrives mid call

#### 11.4.2 FXO – Analogue Caller ID detection (CLID) – H.323 and SIP

Incoming caller id is configured using 3 parameters,

```
[pots.port.n]
  callerid = on/off

[pots]
  callerid_type = caller id type
  callerid_wait = time to wait to see if a callerID is being
                  presented - if time is exceeded then the Vega
                  assumes that no caller ID will be received.
```

Vega FXO ports do not support the generation of caller ID.

Some caller ID generation methods provide no warning that caller ID is about to be delivered. i.e. there is no initial ring splash or line whetting pulse. For these installations the Vega can now allocate a DSP resource to permanently listen for caller ID tones.

The Vega will only allocate a permanent DSP resource where there is line voltage present on the FXO port (i.e. there is a connected device) and the configured caller ID type doesn't provide any warning of caller ID delivery. i.e. One of the following types of caller ID is configured:

```
etsi-fsk
```

```
etsi-dtmf
```



**WARNING!**

**This permanent allocation may affect the ability of other ports on the gateway to complete calls. This affects gateways where there are both FXS and FXO ports.**

##### 11.4.2.1 SIP Presentation Field

This presentation field address extension may be present in the From: header of an INVITE as:

```
"presentation =" ( "anonymous" | "public" | "unavailable")
```

If caller ID is on, the caller ID will be displayed (passed on) if:

- There is NO presentation address extension in the From: header of the INVITE message
- The INVITE message's presentation is "public"

Caller ID WILL NOT BE DISPLAYED (will not be passed on) if:

- The INVITE message's presentation is "unavailable", in which case the phone will display "OUT OF AREA"
- The INVITE message's presentation is "anonymous", in which case the phone will display "BLOCKED CALL"

If there is no caller ID to put in the From: field (none supplied, presentation restricted etc.) then "Unknown" will be used.

See also RPID handling in section [Error! Reference source not found. "Error! Reference source not found."](#)

#### 11.4.2.2 H.323 extensions

Additional parameters are available to configure the text of the messages that are sent over H.323 under specific received caller ID situations:

```
[advanced.h323control]
nocallerid=<no caller id text>
notavail=<no caller id available text>
restricted=<caller id is restricted text>
```

### 11.5 Power fail fallback operation

Vega FXS gateways which include 2 FXO ports support power fail fallback. If the Vega is powered down, rebooted, or in the middle of an upgrade, it will use fall back relays to connect the first two FXS ports to the two FXO ports. This provides emergency telephony, even under VoIP-down conditions.

On returning to an active state, the Vega samples the condition of the FXS < -- > FXO lines, if either are in use, it will delay removing the relay connection until both are free.

## 12 H.323 CONFIGURATION

H.323 variants of the Vega gateway are designed to operate in one of two modes:

Gatekeeper mode

Standalone mode (no gatekeeper)

In Gatekeeper mode, at power up or re-boot the Vega will register with the gatekeeper, and then for each call the Vega will send the call details (like called number, calling number, name and if appropriate TA: and TAC:) to the gatekeeper and the gatekeeper will carry out the authentication, routing and translation, providing the Vega with destination dialled number, name and if appropriate TA: information.

In standalone mode, the Vega dial planner effectively implements a subset of gatekeeper functionality, carrying out the authentication, routing and translation internally.

Therefore, when a gatekeeper is used, the dial planner is typically much simpler than for standalone mode as the gatekeeper will do the number translations etc.

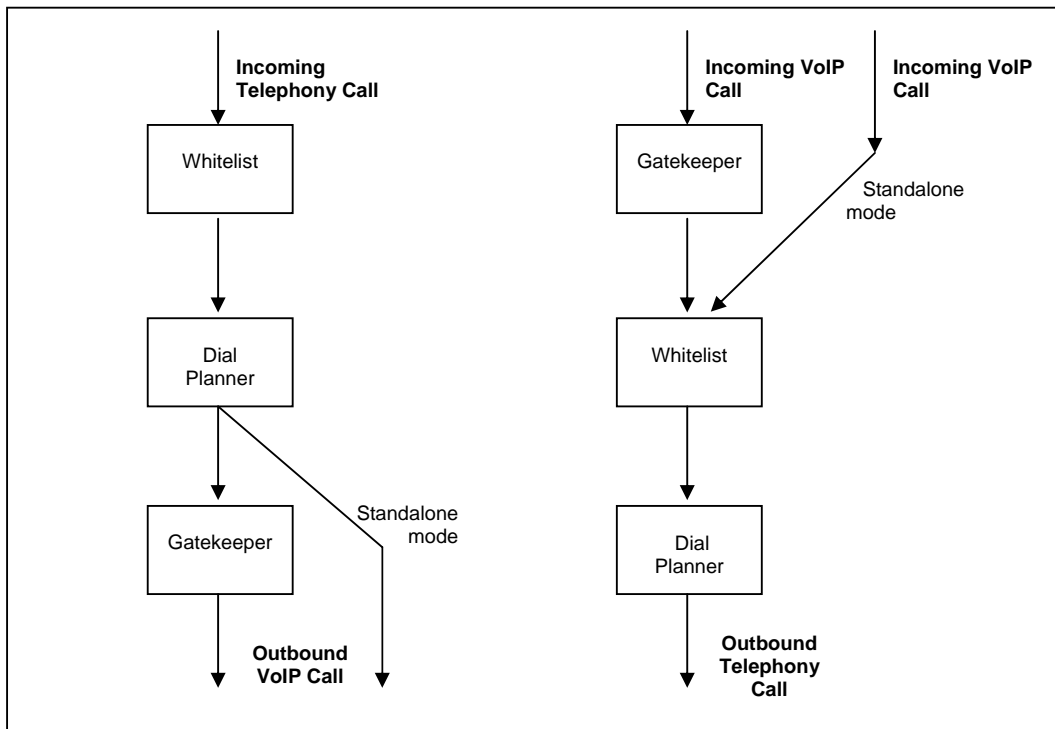

To select the mode of operation configure `h323.gatekeeper.enable` on the CLI or select the appropriate “Gatekeeper Mode” or “Standalone” button on the H.323 page on the web browser interface.

## 12.1 Standalone Mode

In standalone mode (`h323.gatekeeper.enable=0`) the Vega dial planner needs to be configured to contain all operations for authentication, routing and translation.

Details on configuring the dial planner can be found in section [8 "The Dial Planner"](#).

In some cases it is required that most calls are to be routed to the same destination on the LAN (e.g. another gateway); to do this, a default H.323 endpoint address can be set up. This endpoint address is used in all cases where an explicit ongoing IP address is not specified in the dial plan entry.

```
[h323.if.x]
  default_ip=www.xxx.yyy.zzz
  default_port=1720
```

NOTE

For readability, it is recommended that the TA: token is used explicitly in all dial plan entries rather than using the `default_ip` parameter

## 12.2 Gatekeeper Mode

In gatekeeper mode (`h323.gatekeeper.enable=1`) a number of parameters need to be set up to allow registration and authentication to take place with the gatekeeper. Specifying which gatekeeper to use is carried out by either specifying a static IP address/host name, or by enabling auto-discovery. In the latter case a multicast is used to find the nearest gatekeeper.

To enable auto-discovery set:

```
[h323.gatekeeper]
  auto_discover=1
```

For manual discovery a gatekeeper IP address needs to be specified:

```
[h323.gatekeeper]
  auto_discover=0
  default_gatekeeper=www.xxx.yyy.zzz
```

In either case, during the registration process a number of identifiers (alias") may be sent from the Vega to the gatekeeper to allow authentication of the Vega and to identify which calls the Vega can handle. Each alias can be an email address, a URL, an H.323 id or an E.164 number

For example:

```
[h323.gatekeeper.terminal_alias.n]
  type=h323
  name=Vega
```

Check with your system administrator to see what authentication aliases are required by the gatekeeper. Most gatekeepers require either an H.323 ID or a list of E.164 prefixes.

NOTE

1. Setting `h.323.gatekeeper.terminal_alias_n.name` to NULL means do not send this terminal alias.
2. Terminal aliases are re-registered with the gatekeeper on APPLYing changes

Some gatekeepers decide which calls to route to a gateway based upon the telephone number prefixes that the gateway can handle. In the gatekeeper registration process the Vega will declare all the telephone number prefixes defined in dial plan entries for srce expressions for the LAN interface (IF:05). A telephone number prefix is the fixed length expression before a .\* in a TEL: token.

e.g. 01344 will be declared as a prefix for the dial plan entry:

```
srce=IF:0501,TEL:01344.*
```

NOTE
------

1. Dial plan prefixes are re-registered with the gatekeeper on APPLYing changes
2. For Cisco call manager prefixes need to be preceded by a #. In the Vega dial planner duplicate each prefix dial plan entry and put a # after the TEL: (before the dialled number prefix).

### 12.3 Gatekeeper Registration Status Command and Messages

To monitor the progress of the Vega's registration with the Gatekeeper a number of LOG messages are logged. They are of the form:

```
LOG: 03/04/2001 14:06:42 H323 (A)Rb6C00 GK state xxx (event yyy)
```

The gatekeeper state values can be:

```
Idle                ; gatekeeper is not registered
Discovered          ; gatekeeper is trying to register
Registered          ; gatekeeper is registered
```

If the Vega is configured to be in "gatekeeper mode" it will only make (or receive) VoIP calls when the gatekeeper status is "Registered". To obtain the current registration status, use the CLI command:

```
gatekeeper status
```

### 12.4 Gatekeeper Registration Commands

A number of CLI commands are available to request the Vega to un-register / register with the gatekeeper.

```
gatekeeper unregister
```

- forces the gateway to unregister with the gatekeeper

```
gatekeeper register
```

- forces the gateway to send a registration request to the gatekeeper

```
gatekeeper reregister
```

- forces the gateway to unregister from the gatekeeper and then register with the gatekeeper.

## 12.5 Fast Start

Fast start (or fast connect) is a feature of H.323 which simplifies and speeds up the connect procedure by reducing the number of messages exchanged between the endpoints on making a call. Fast start was added to the H.323 standard at version 2.0 and is not compatible with the earlier version 1.0 H.323 standard. For this reason it is not supported by all H.323 endpoints (and so this feature may sometimes need to be turned off on the Vega).

By default a Vega will accept all incoming fast start connections and will attempt to initiate fast start for outgoing H.323 calls.

The operation of fast start on the Vega can be controlled using the following parameters:

### [h323.profile.x]

```
use_fast_start=1
accept_fast_start=1
h245_after_fast_start=1
```

use_fast_start	controls whether the Vega initiates outgoing H.323 calls requesting fast start.
accept_fast_start	controls whether the Vega will accept fast start information or whether it will force the sender to use Version 1.0 H.323 call setup interactions. The parameter value defines when the faststart will be accepted 3 = in the CALL PROCEEDING message, 2 = in the ALERTING message, 1= in the CONNECT message. If, for example, the parameter is set to 3 and no call proceeding is sent, then the fast start accept will be sent with the alerting or if there is no alerting, it will be sent with the connect.
h245_after_fast_start	controls whether a channel is created for media control during fast start. Usually fast start chooses not to open a separate media signalling channel, but with this value enabled it will do so if requested by the other endpoint. (The H245 media control connection is required for Out-of-band DTMF)

## 12.6 Early H.245

Early H.245 is a feature that allows a voice path (or media channel) to be created between two H.323 endpoints before the call has been accepted. This has many advantages over establishing the media channel after successfully connecting:

Call progress tones from the B-party can be heard during call setup (e.g. ringback)

Call progress tones from the B-party can be heard during unsuccessful call setup (e.g. busy tone, recorded announcements)

Call connection times are reduced because the media channel has already been connected before the user answers

This is a Version 2.0 H.323 feature and is therefore only compatible with other Version 2 compliant endpoints. To control the use of early H.245, the following configuration parameters have been provided:

```
[h323.profile.x]
  use_early_h245=0
  accept_early_h245=1
```

The default behaviour is to accept early H.245 if it is requested, but *not* to initiate it for outgoing calls.

## 12.7 H.245 Tunnelling

H.245 tunnelling reduces the number of TCP/IP connections made per call by eliminating the need for separate sockets for both call signalling (Q.931) and channel signalling (H.245). This feature can be enabled and disabled for both incoming and outgoing calls independently as follows:

```
[h323.profile.x]
  use_h245_tunnel=0/1           [default=1]
  accept_h245_tunnel=0/1       [default=1]
```

use... indicates use tunnelling for outgoing H.323 calls,  
accept... indicates allow tunnelling on incoming H.323 calls.

The default configuration is that this more efficient mode of operation is enabled for both outgoing and incoming calls.

### NOTE

If the called/calling H.323 endpoint does not support h.245 tunnelling then, even with “use/accept” enabled the call will automatically proceed by connecting an H.245 socket as though H.245 tunnelling were disabled.

## 12.8 Round trip delay

Round trip delay monitoring is used to check whether a LAN connection is lost during a VoIP conversation. This is especially useful for wireless endpoints which may go out of wireless range during the call – if the round trip delay messaging stops getting a response, the call is cleared down with a configurable cause code. Round trip delay is configured using the following parameters:

```
[_advanced.h323]
  rtd_failure_cause=41           ; RTD failure cause code
[h323.profile.x]
  rtd_interval=0                 ; Interval between sending RTD
                                ; response requests
  rtd_retries                     ; Number of times to retry
                                ; response request before
                                ; failing link

[_advanced.rad.h245]
  roundTripTimeout=5            ; Time to wait looking for RTD
                                ; resonse - see roundTripTimeout
```

### 12.8.1 Round trip delay (RTD) operation

Although round trip delay is configured on a per unit basis, round trip delay testing is carried out on a per call basis. So, for every active call:



- when round trip delay is enabled (`rtd_interval <> 0`) at every `rtd_interval` period an RTD request response (like a ping) is sent out to the endpoint associated with this call
- the Vega waits `roundTripTimeout` time for a reply after sending the RTD request response; if it is not received within the specified time the Vega increments the RTD fail count for that call, if the response is received within the `roundTripTimeout` time, then the RTD fail counter for that call is cleared
- if the RTD fail count exceeds the retry count (`rtd_retries`) the link is deemed to have failed and the call is cleared down and the reason for clear down given as `rtd_failure_cause`.

Typically, if an endpoint is going to respond to the RTD response request, it will do so promptly, so `roundTripTimeout` can be set smaller than `rtd_interval`.

**NOTE**

In practice, if round trip delay monitoring is not enabled, or the delays for RTD detection are long, the TCP socket will timeout and break the signalling connection.

## 12.9 H.450 – for Call Transfer / Divert

### 12.9.1 Introduction

H.450 is the set of standards used by H.323 to provide Supplementary Service Support.

H.450.1	H.450 Series Title
H.450.2	Call Transfer
H.450.3	Call Diversion
H.450.4	Call Hold
H.450.5	Call Park/Pickup
H.450.6	Call Waiting
H.450.7	Message Waiting Indication
H.450.8	Name Identification Service
H.450.9	Call Completion on Busy Subscriber
H.450.10	Call Offer
H.450.11	Call Intrusion

### 12.9.2 H.450.2 – Call Transfer

H.450.2 provides the capability to transfer calls. It provides mechanisms for one party (the transferring party) to instruct a remote party (the transferred party) with which it is currently in a call, to be transferred to a third party (the transferred-to party).

If the call transfer is actioned when the transferring party is in a call with the transferred-to party, this is known as a transfer with consultation.

If the transferring party is not already in a call with the transferred-to party then the transfer is known as a transfer without consultation.

#### 12.9.2.1 Transferring Party Support

Vegas do not support the functionality of a transferring party. i.e. There is no support for initiating transfer requests.

#### 12.9.2.2 Transferred-to party support

Incoming calls specifying that they are H.450.2 transfers will be accepted. There is however no support for Transfer with Consultation.

#### 12.9.2.3 Transferred party support

During an active call a transfer instruction from the remote endpoint (transferring party) will cause the Vega to initiate a new outgoing call to the specified destination (transferred-to party).

- If the transferred-to party supports H.450.2 the original call will be released when the transferred-to party accepts the transfer. If this is before the transferred-to party call is connected a ringback tone will be played to the transferred party.
- If the transferred-to party does not support H.450.2 the original call will only be released when the transferred-to call is connected.

Transfers with Consultation will be accepted provided that the Transferring party does not require any specific support from the Vega gateway while it makes the consultation call.

#### 12.9.3 H.450.3 – Call Diversion (For test purposes only)

NOTE

This feature has not been fully released and therefore should only be used in test lab environments

H.450.3 provides the capability to forward calls before they are answered. It provides a mechanism for a called endpoint (Diverting Party) to instruct the calling endpoint (Diverted Party) to divert the call to a third endpoint (Diverted-to Party). Reasons for diversion are controlled by the Diverting Party and can include Divert on Busy, Divert on No Answer, Always Divert.

##### 12.9.3.1 Diverting Party

Vegas do not support the functionality of a diverting party. i.e. There is no support for initiating divert requests.

##### 12.9.3.2 Diverted-to Party

The Vega will accept calls diverted-to it, however there is no support for informing the diverted-to party that this is a diverted call or the reason for the call diversion.

##### 12.9.3.3 Diverted Party

All diversion reasons will be accepted and a redirected call generated. Multiple redirections are supported, ie if Vega A calls endpoint B, which redirects to C it is possible for C to re-divert to D (resulting in a call A to D)

### 12.9.4 H.450 Configuration

#### [serviceprofile.n]

defines the Supplementary services that are to be supported. This allows up to 10 distinct profiles to be defined. Each profile has the following parameters:

#### [serviceprofile.n]

```

name           ; a text identifier
transfer       ; 0 = do not support call transfer, 1 = support call transfer
divert         ; 0 = do not support call diversion, 1 = support call diversion
transfer_caller_id ; = transferring_party / transferred_party -
                  defines which caller ID is displayed when a call is
                  transferred to the Vega.

```

Changes to serviceprofile parameters take immediate effect, being used for the next call that uses the corresponding profile.

The default configuration contains a single profile in which all services are enabled.

#### [h323.if.x]

serviceprofile

is an integer that selects the service profile to be used for H.323 calls. If this value is set to zero all supplementary services are disabled for H323. Otherwise the corresponding serviceprofile defines which supplementary services will be enabled. It is made effective using the APPLY command.

The default configuration is `serviceprofile=0`, i.e. supplementary services are disabled.

#### [\_advanced.h450]

contains some general parameters and sections for each supported standard. All parameter under here are effective on save and reboot.

#### [\_advanced.h450]

```

max_calls
max_services

```

these parameters control the amount of resource that the Radvision stack will allocate to support the H.450 functions.

#### [\_advanced.h450.h450\_2]

```

timer_ct-t1=20
timer_ct-t2=22
timer_ct-t3=24
timer_ct-t4=26

```

these parameters are timers for H450.2

#### [\_advanced.h450.h450\_3]

```

timer_t1=20
timer_t2=22
timer_t3=24
timer_t4=26
timer_t5=28

```

these parameters are timers for H450.3

All these parameters should only be altered from their default values on advice from VegaStream engineers.

## 13 MEDIA

The following codecs are supported:

- G711ALaw
- G711ULaw
- G729
- G723.1
- GSM-FR
- T.38
- ClearMode

Both RTP (Real Time Protocol) and SRTP (Secure Real Time Protocol) are supported.

### 13.1 Media Channels and CODECS

#### 13.1.1 H.323 Media Channels and CODECS

In the process of making an H.323 VoIP call, (i.e. a call to IF:0501) each endpoint sends a list of codecs that it supports ("a capability set list") to the other endpoint involved in the call. The order in which the codecs are listed defines the desired priority of use. The first codecs are the most preferred, and the last listed codec is the least preferred. The two endpoints then independently choose one of the offered codecs to use to send their audio.

Depending on the type of service being provided a different set of codecs may need to be offered, or at least the preferred priority order of the codecs may need to be altered.

The list of voice codecs that an H.323 Vega gateway offers, and the priority order in which they are offered is affected by the version of code, the mode of operation, and a number of configuration parameters.

Vega gateways use different parameters to select the codecs to offer depending on whether the mode of operation is fast-start or not. For example, a small set of codecs can be offered on an initial fast-start, with perhaps a wider range then offered if the fast-start negotiations fail.

Faststart:

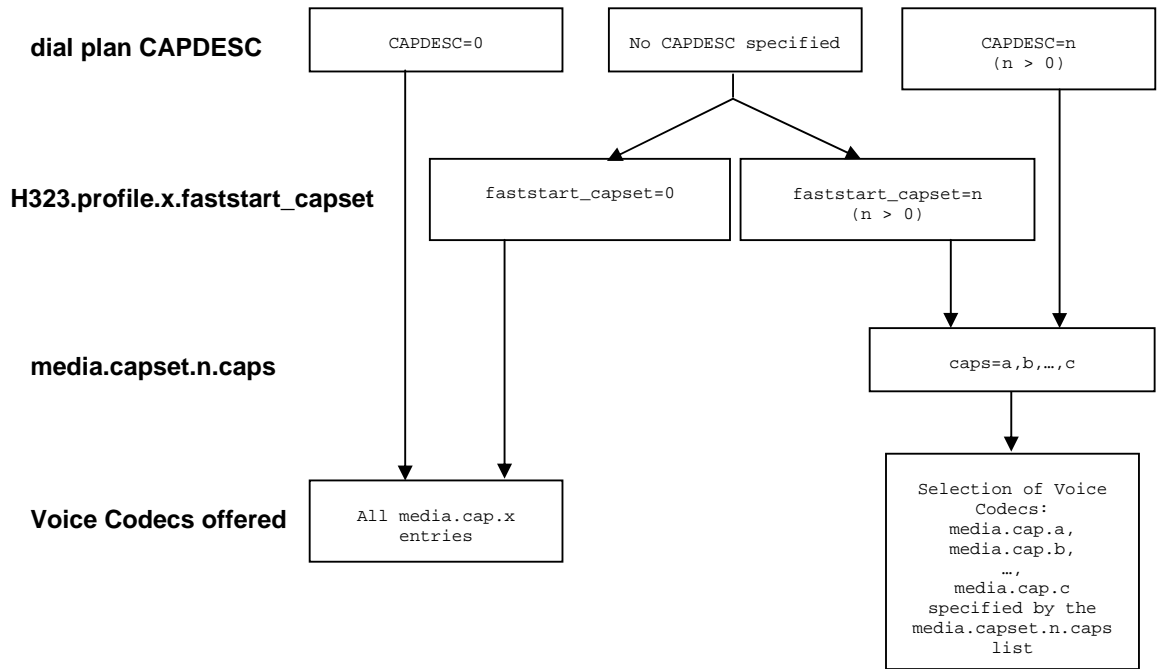

Non faststart:

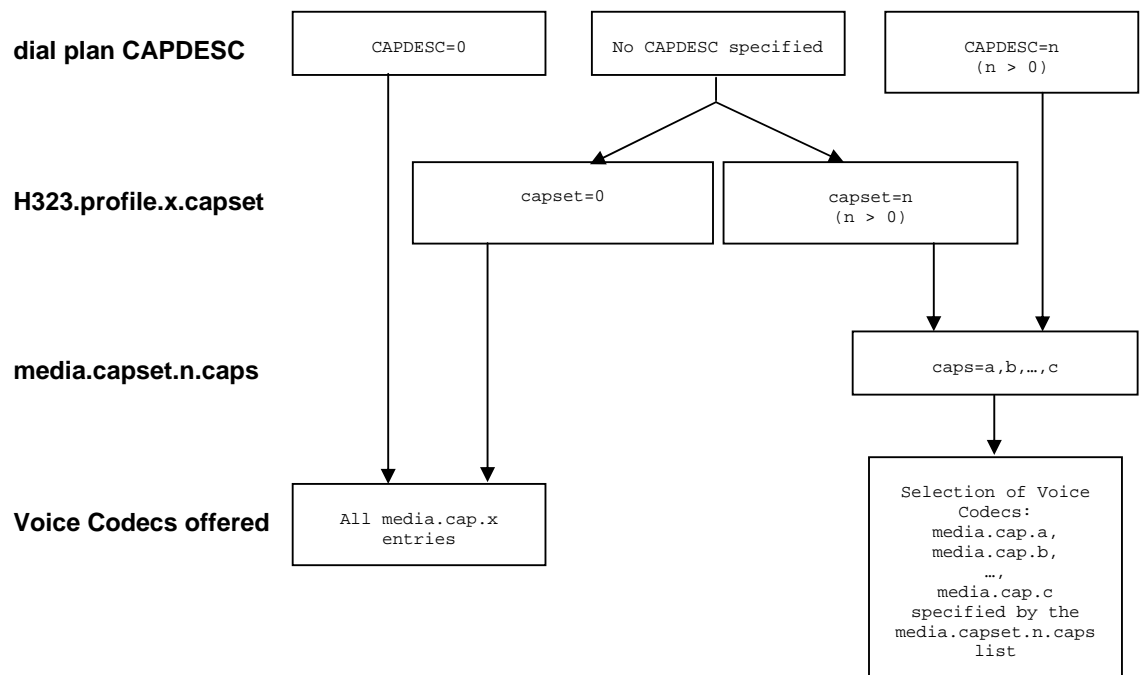

In the dial planner a token `CAPDESC:` can be used (in a `dest` statement where the interface is `IF:0501`) to specify which codec set (`media.capset.n.caps` list) is to be used to specify the list of codecs to offer (and their priority order).

If `CAPDESC:0` is specified, rather than using the `media.capset.n` list, then all codecs that the Vega has been configured to support, the whole list of `media.cap.x` entries, will be offered in the priority order `x=1` highest, `x=2` second priority etc.

If the dial plan does not specify a `CAPDESC:` then depending on whether it is a fast-start negotiation or not, either the parameter `h323.profile.x.faststart_capset`, or `h323.profile.x.capset` will specify the default codec set to offer. (Note, if a faststart negotiation is attempted and fails causing drop-back to standard H.323 codec negotiation, or if re-negotiation of codecs is required during the call – e.g. to add fax capabilities to the call – then `h323.profile.3.capset` will specify the codecs offered.) If the `faststart_capset`, or `capset`, whichever is being used is set to 0, then the selection of codecs offered will be the same as if `CAPDESC:0` had been specified in the dial plan. If the parameter `=n`, where `n > 0` then the selection of codecs offered will be the same as if `CAPDESC:n` were specified in the dial plan.

NOTE
------

1. Vegas do not support asymmetric codecs (i.e. different codecs for send and receive) – If this occurs with certain endpoints, use `CAPDESC` to reduce the codecs offered to those endpoints.

### 13.1.2 SIP Media Channels and CODECS

In the process of making a SIP VoIP call, (i.e. a call to `IF:9901`) the initiating end sends a list of codecs that it supports in an SDP. (The order in which the codecs are listed defines the preference order for usage of the codecs).

The receiving end chooses a codec that it also supports and responds with its own SDP choosing just one of the offered codecs as the codec to use for the call.

The codecs that a Vega offers (when it sends the initial sdp) and the codecs that the Vega compares the offered codecs list against to decide which codec to accept are configurable.

The codecs to be used are specified as follows:

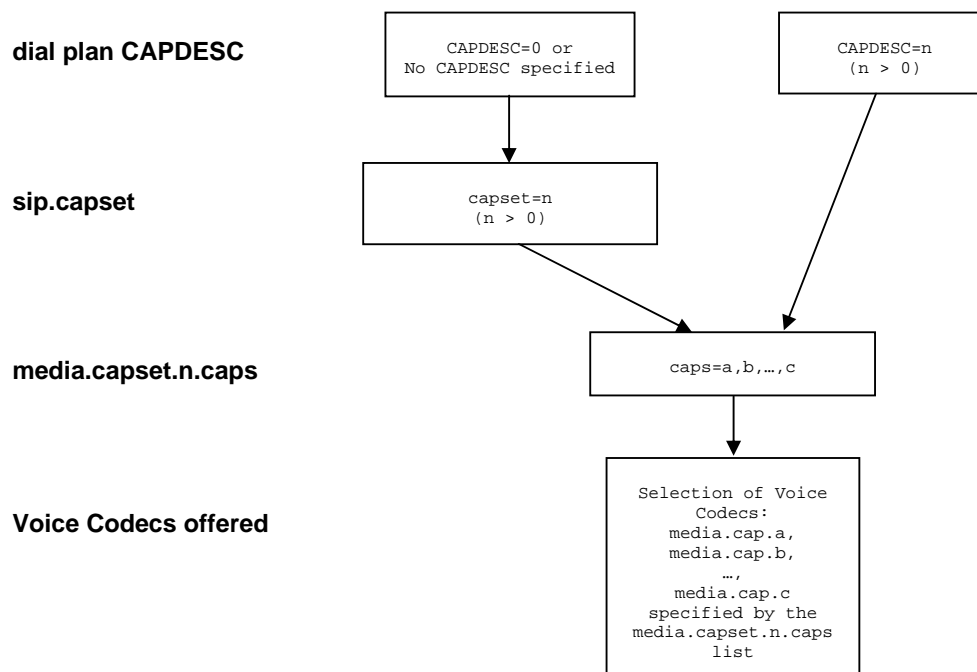

In the dial planner a token `CAPDESC:` can be used (in a `dest` statement where the interface is `IF:9901`) to specify which codec set (`media.capset.n.caps` list) is to be used to specify the list of codecs to offer (and their priority order).

If `CAPDESC:0` is specified, or if the dial plan does not specify a `CAPDESC:` then the parameter `sip.capset` will specify the codec set to offer. `sip.capset` can only take values  $> 0$ ; its value specifies the codec set (`media.capset.n.caps` list) to be used to specify the list of codecs to offer (and their priority order).

**NOTE**

1. Vegas do not support asymmetric codecs (i.e. different codecs for send and receive).

Parameters for the individual codecs may be adjusted under the relevant sections of the DSP configuration subsection (“Media Channels” section on the web browser) see section [13.3 “SIP and H.323 - Configuring CODEC Parameters”](#).

When the SIP Vega makes a call it offers the codecs (in the same order as specified in the media capset) to the far end gateway – the far end gateway will choose one of the codecs to use. When receiving calls, the Vega will look through the incoming list of offered codecs and will accept the first (highest priority) offered codec which matches one of those listed in its own media capset list.

### 13.1.3 CAPDESC – Capability descriptors list

The `CAPDESC` token in the dial planner provides a per-call mechanism to select the CODECs offered over H.323 or SIP:

`CAPDESC:n`

This token, which is placed in the destination part of the dial plan entry (for calls to IF:0501 or IF:9901), forces a particular list of CODEC types to be advertised in the capabilities for this outgoing call. The list of the CODECs to be offered is defined in the `media.capset.n` section of the configuration parameters, for example:

```
[h323.profile.x]
  faststart_capset=0
  capset=0

[sip]
  capset=2

[media.cap.1]
  codec=g7231

[media.cap.2]
  codec=g711Alaw64k

[media.cap.3]
  codec=g711Ulaw64k

[media.cap.4]
  codec=t38tcp

[media.cap.5]
  codec=t38udp

[media.capset.1]
  caps=1,2,3

[media.capset.2]
  caps=2,3
```

In the above example the selection of `media.capset` entry 1 causes all configured codecs (G.723.1, G.711Alaw64k and G.711Ulaw64k) to be offered. `media.capset` entry 2 however has been restricted to offer G.711 only (A law and U law).

With this configuration, if `CAPDESC:2` is used in a dial plan destination expression it will force only the G.711 codecs to be advertised for calls using this dial plan entry.

NOTE
------

The `media.capset.n` lists define both the subset of codecs to offer and also the priority order in which they will be offered.

Vegas support both G.723.1 and G.729A (G729) compression standards at the same time, though due to DSP memory addressing capabilities, individual DSPs cannot run code for all codecs at the same time. The DSP memory can be loaded with code to support G.711Alaw, G.711Ulaw and G.723.1 or G.711Alaw, G.711Ulaw and G.729A (G729).

At boot up the Vega loads different DSPs with different code images in order to reduce the likelihood of having to load new code on the fly. The `media.cap.n.codec` entries define which code images to load. If a codec is negotiated and there is no spare DSP resource with that code loaded, in the background, a DSP will be loaded with the appropriate code image.

### 13.1.4 Defining Fax capabilities

#### 13.1.4.1 Fax capabilities

Fax capabilities are treated as codecs. Two fax only codecs are available for H.323: `t38tcp` and `t38udp` – the TCP and UDP variants of T.38 respectively; for SIP, the specifications only define a single codec `t38udp` – the UDP variants of T.38.



If t38tcp and / or t38udp are to be used then `media.cap.n` entries have to be created for them.

To offer T.38 codecs for fax, add the capabilities to an appropriate `media.capset.x`

Whether to include the capability in the `h323.profile.x.faststart_capset`, `h323.profile.x.capset`, `sip.capset` or just in a capset that can be called up using CAPDESC in a dial plan depends on how and when the fax codecs should be offered.

In H.323, this can depend upon the other fax devices in the network, e.g. some VoIP gateways like to set up the fax capabilities right at the start of the call, and so in this case fax codecs should be included in the H323 `faststart_capset`. Others only want to negotiate fax if and when required; in this case do not include it in the H323 `faststart_capset`, but include it in `h323.profile.x.capset`.

NOTE	For H323 firmware, selection of only one t.38 fax codec (either t38udp or t38tcp) is recommended where possible – many products do not respond properly when offered more than one fax codec, and this can lead to invalid codecs being chosen.
------	-------------------------------------------------------------------------------------------------------------------------------------------------------------------------------------------------------------------------------------------------

## 13.2 SIP Media Channels And CODECs

Vegas support both G.723.1 and G.729A (G729) compression standards at the same time, though due to DSP memory addressing capabilities, individual DSPs cannot run code for all codecs at the same time. The DSP memory can be loaded with code to support G.711Alaw, G.711Ulaw and G.723.1 or G.711Alaw, G.711Ulaw and G.729A (G729).

At boot up the Vega loads different DSPs with different code images in order to reduce the likelihood of having to load new code on the fly. The `media.cap.n.codec` entries define which code images to load. If a codec is negotiated and there is no spare DSP resource with that code loaded, in the background, a DSP will be loaded with the appropriate code image.

For details on configuring which codecs a SIP Vega will offer (and accept) when making and receiving calls, see section [15.4.3 "SIP SDP 'a=' ptime and direction "](#)

## 13.3 SIP and H.323 - Configuring CODEC Parameters

Each codec has some specific parameters that can be altered. The codec parameters are grouped under codec type. Some of them are a parameter associated with the telephony and VoIP interfaces, others which are more call related. The two types are stored in separate areas, `dsp.xxx` and `media.packet.codec.y`. Each parameter takes effect on the next call attempt after a change has been made; this allows the user to 'tweak' settings to obtain the optimal configuration for a given situation. The available parameters are listed in the tables below.

Interface related parameters:

Parameter <code>dsp.xxx</code>	Description	Effect of increasing / enabling this parameter	Other notes
VP_FIFO_nom_delay	minimum jitter buffer size in milliseconds	1) improves audibility of received audio when interworking with software based codecs (e.g. Microsoft Netmeeting) which introduce permanent jitter. 2) Improves audibility of received audio when connecting over the internet, or other data networks where there is	Set this value $\geq 2$ to 3 times the "packet time" or to the maximum observed jitter on the LAN network plus 1 "packet time" (whichever is the larger value) – but do not set it larger than it needs to be; the larger the value the larger

Parameter dsp.xxx	Description	Effect of increasing / enabling this parameter	Other notes
		significant jitter. 3) Increases the delay for the voice path	the latency, and the lower the perceived quality.
VP_FIFO_max_delay	maximum jitter buffer size in milliseconds	1) improves the audibility on data networks which introduce random amounts of jitter. 2) In cases of large jitter this will increase voice path delay	This value defines the maximum size the FIFO can dynamically grow to – leave this set at maximum for best results <sup>7</sup>
Echo_tail_size	amount of echo cancellation used in milliseconds	1) eliminates echo up to length selected 2) introduces fixed length delay of length selected	Leave at the default of 16ms unless echo is a problem. If it is increase to 32, 64 or 128 as proves necessary <sup>8</sup>
VADU_threshold	silence suppression activation threshold	increases the level at which the codec will differentiate between background noise and speech. I.e. when not to send audio and when to send audio if VADU_enable_flag is set.	Generally leave this as default – may need to increase if background noise level is high (otherwise the VAD detector will never trigger)
idle_noise_level	background “comfort” noise level	increases the level of ambient noise generated in the listeners ear when no audio is received from the source gateway (due to VAD detector detecting “silence” and so not sending audio packets)	Generally leave this set at the default value
tx_gain	packet transmit gain	increases the sound level for packets transmitted across the LAN	Typically limit gain increases to <=7 ... more than this can result in clipped audio.  On FXO units this alters the gain of DTMF tones from the PSTN/PBX – too much adjustment can take the tone volumes out of spec.
rx_gain	packet receive gain	increases the sound level for packets received from the LAN	Typically limit gain increases to <=7 ... more than this can result in clipped audio.

## Per call related parameters:

Parameter media.packet.codec.y	Description	Effect of increasing / enabling this parameter	Other notes
out_of_band_DTMF	out of band DTMF tone enable / disable	When enabled: 1) introduces a slight fixed delay into the voice path 2) the Vega detects and deletes the DTMF tones from the Audio stream that is to be sent across the LAN – it sends messages across the signaling link to tell the far end what DTMF tones it detected. The far end Vega will then re-generate the tones so that they are pure to the destination.	Need to use out_of_band_DTMF for G.723.1 as it compresses audio so much that when audio is expanded at the far end the tones are not accurately reproduced.  For G.711 and G.729 out_of_band_DTMF may be selected or not as desired.

<sup>7</sup> If the two VoIP endpoints are not synchronised through their telecoms interfaces then slip can occur causing the fifo buffers to run near empty then empty or near full then over full. If excessive delays are observed it may be best to reduce the Max delay value to limit the maximum delay, BUT note that if slip occurs beyond the Max delay then audio will be lost and intelligibility of audio will be degraded.

<sup>8</sup> Vega 100 units require special firmware builds to support 64 and 128ms echo tail size – use [showdsp](#) to see the DSP capabilities. (Note, long echo tail size builds may limit the maximum number of simultaneous calls an E1 Vega can handle.)

Parameter media.packet.codec.y	Description	Effect of increasing / enabling this parameter	Other notes
packet_time	size of voice packets transmitted by Vega in milliseconds	1) improves reception on busy reliable networks by decreasing the number of packets transmitted per second 2) increases the likelihood of audible sound loss on unreliable networks – 1 packet contains more audio 3) Reduces bandwidth required to transfer audio 4) Increases latency	The smaller the packet time the higher the perceived quality due to lower latency
VADU_enable_flag	silence suppression enable / disable	enabling will 1) introduce a slight voice path delay 2) result in packet suppression on the network when no-one is speaking.	Enabling this can introduce clipping of speech – if this is observed try disabling this feature

### 13.4 G.729 / G.729 Annex A/B Codecs

The G.729 Codec is variously known as G.729, G.729 Annex A and G.729 Annex B, or even G.729 Annex A/B. G.729 is the original codec name, and also the generic name. Annex A introduced a codec which is interoperable with G.729 but is mathematically a lot less complex (therefore much more affordable in terms of DSP processing power). Annex B then added the optional (programmable) silence suppression. Vega gateways use the G.729 Annex A/B version of codec, whether the G.729 or G.729 Annex A variety is selected as it is backward compatible with the other variants:

#### H.323

- Two codec names G.729 and G.729 Annex A are supported by the Vega for backward compatibility. In H.323 some products negotiate for a codec called G.729AnnexA (as defined in the H.323 specification), others for a codec named G.729 (not per specification). Vegas allow negotiation for both codecs. By allowing each to be selected as a separate codec, different parameters can be provisioned for the two.

#### SIP

- RTP/AVP in SIP sdp is configured as a numeric value, 18 for G.729. In Vega gateways this enables a G.729 Annex A/B codec which is backward compatible with both G.729 and G.729 Annex A. Enabling G.729 or G.729 Annex A in media.cap.n will ensure that there are G.729 Annex A/B codecs immediately available for use (see section [13.2 "SIP Media Channels And CODECs"](#)).

NOTE
------

To change the parameters for the SIP G.729 codec, change the parameters in the G.729 section (not the ones in the G.729 Annex A section).

## 13.5 Out of band DTMF (OOB DTMF)

Compression CODECs such as G.723.1 and to a lesser extent G.729 distort audio because they must lose information in order to perform the compression. For normal speech this distortion is insignificant and hardly affects the intelligibility of the speech. However, in the case of pure tones (such as DTMF) this distortion modifies the tones enough that they are no longer within specification, and so DTMF detectors may not recognise the tones. The solution is to detect the tones before the audio is compressed, remove the tones from the audio stream and send the DTMF information as separate packets – out of the audio stream – to the far endpoint, which will then generate a pure DTMF tone back into the audio stream.

Such a mechanism is known as out of band DTMF, and is supported in all Vega products (SIP and H.323) for both transmission and reception.

By default the feature is enabled for all CODECs except G.711 A and u law (G.711 codecs will pass DTMF tones through uncorrupted). To change the setting use the `media.packet.codec.y.out_of_band_DTMF` parameter in the configuration database.

### 13.5.1 H.323 out of band DTMF

In H.323, Out-of-band DTMF information is sent in H.245 UserInputIndication messages – they can be sent in two formats: “alphanumeric or simple mode”, and “signal mode”. Vega gateways will accept OOB DTMF messages generated in either format. By default Vega gateways will use the “signal” type format to send OOB DTMF information, but this can be configured in the following configuration parameter:

```
[h323.profile.x]
  oob_method=signal ; alphanumeric=alphanumeric/simple; signal=signal;
  none=none
```

“Alphanumeric / simple mode” does not support DTMF tone duration information.

“Signal mode” supports optional timing information. (However, Vega gateways do not send timing information, and ignore any received timing information).

### 13.5.2 SIP out of band DTMF

In SIP, Out-of-band DTMF information can either be sent in Info messages, or from using RFC2833.

For further details on RFC 2833 see section [15.5 “RFC2833”](#)

For further details on Info messages see the [SIP Signalling Messages Appendix](#).

## 13.6 Tones

### 13.6.1 Configuring Local Call Progress Tones

During call establishment, and usually during call disconnection the caller hears call progress tones. These tones include: busy tone, ringing tone, unobtainable, etc. Sometimes these are generated by the Network, sometimes the Vega passes the audio through from another device and sometimes the Vega generates the call progress tones itself.

Because each tone cadence may vary from country to country, the Vega provides a facility for the user to change their definition. Configuration is via a three tiered set of configuration parameters,

[tones], [tones.def] and [tones.seq]. These parameters can be configured directly through a CLI interface or via the web browser from the menu “tones”.

The [tones] section provides a mapping of the call progress tones that the Vega offers to specific tone sequence IDs:

```
[ tones ]
dialtone_seq=1      ; general dial tone for making calls
stutterd_seq=2     ; stutter dial tone (not implemented on H.323)
busytone_seq=3     ; busy tone on cause 17
fastbusy_seq=4     ; fast busy tone for number not found
ringback_seq=5    ; ringback tone for far end ringing
callwait1_seq=6   ; call waiting tone 1 (not implemented on H.323)
callwait2_seq=7   ; call waiting tone 2 (not implemented on H.323)
```

The [tones.seq] section specifies the sequences. For each sequence ID the list of raw tones, their duration and their order are specified. The duration value is measured in milliseconds; a value of 0 means play the tone forever. E.g. tone sequence ID 1 plays tone 1 for 10 seconds then tone 6 forever:

```
[ tones.seq.1 ]
name=dial_seq
repeat=0
[ tones.seq.1.tone.1 ]
play_tone=1
duration=600000
[ tones.seq.1.tone.2 ]
play_tone=6
duration=0
```

If the tones that make up the sequence are all of finite duration, the “repeat” parameter defines whether the sequence of tones are played just once in sequence (`repeat=0`) or are played repeatedly in sequence (`repeat=1`).

The [tones.def] section specifies the raw tones:

```
[ tones.def.1 ]
name=dialtone
freq1=350
amp1=6000
freq2=440
amp2=6000
freq3=0
amp3=0
freq4=0
amp4=0
on_time=0
off_time=0
repeat=1
```

This parameter structure allows the tone to be defined consisting of up to 4 different frequencies; each frequency has an associated amplitude with it. Within this parameter structure it is also possible to specify an `on_time` and an `off_time` so that pulsed tones can be specified. If `on_time=0` then this means play the tone forever, if `on_time<>0` then the `off_time` – silence – follows the `on_time`. The `repeat` can be used to repeat pulsed tones.

Tone definition parameter summary:

Parameter	Range	Description
<code>amp1, amp2, amp3, amp4</code>	0-32,500	Relative amplitude
<code>freq1, freq2, freq3, freq4</code>	0-4,000	frequency (Hz)
Name	31 chars	descriptive string
<code>on_time</code>	0-10,000	duration (ms) of tone on (0=play tone forever)
<code>off_time</code>	0-10,000	duration (ms) of tone off
Repeat	0 (FALSE) Or: 1 (TRUE)	for one-shot tone, set to 0. for <code>on_time, off_time</code> tone cycle to repeat, set to 1.

### 13.6.2 Fixed Tone Table

In addition to the configurable tone table above, the Vega has a set of pre-defined tones for DTMF and Silence. The CLI command `show fixed tones` lists the index numbers of the fixed DTMF tones in case you ever need to use them in tone sequences.

```
LIST OF FIXED TONES
-----
name                index
DTMF_0              100
DTMF_1              101
DTMF_2              102
DTMF_3              103
DTMF_4              104
DTMF_5              105
DTMF_6              106
DTMF_7              107
DTMF_8              108
DTMF_9              109
DTMF_A              110
DTMF_B              111
DTMF_C              112
DTMF_D              113
DTMF_HASH           114
DTMF_STAR           115
SILENCE             116
```

DTMF tones have the following characteristics:

```
amp1=10000, amp2=10000, on_time=80ms, off_time=50ms, repeat=0
```

### 13.6.3 Selecting Generation of Progress Tones vs Media Pass Through

#### 13.6.3.1 H.323 tx\_media\_before\_connect

The `tx_media_before_connect` parameter only affects telephony to H.323 calls; it allows the user to control whether media (RTP traffic) may be sent before answer (connect). If set to 0, then the RTP data is not generated until a CONNECT message has been received on the H.323 interface. If set to 1, then RTP data is generated as soon as the H.323 protocol negotiations allow.

```
[h323.profile.x]
```

```
tx_media_before_connect=0/1 [default=0]
```

**NOTE**

If set to 1, some software endpoints have been found to forward the audio before the phone has been answered

#### 13.6.3.2 SIP progress\_if\_media

The `progress_if_media` parameter allows the user to force the use of 180 Ringing (rather than 183 Session Progress) if an ISDN ALERTING message is received with an in-band media indicator.

It may alternatively be used to force the use of a 183 message if media is generated locally by the Vega.

if `progress_if_media=0`, then 180 ringing is always used to indicate ringing (whether media exists for the ringing cadence or not; if media exists, an sdp will be present)

if `progress_if_media=1`, then if media exists for the ringing a 183 Session Progress will be used (instead of the 180 Ringing). If no media is available for ringing, (in ISDN a flag indicates whether or not there is inband audio) then a 180 Ringing will be used. Note this acts upon the indicator in the ISDN messaging and is not overridden by the decision to generate tones locally (`tones.net.ring=1`)

if `progress_if_media=2`, then if media exists, either from the incoming call, or generated locally (`tones.net.ring=1`) 183 with sdp will be used, otherwise if no media a 180 will be used.

In each case RTP audio will be sent as soon as SDPs are agreed and media is available.

```
[_advanced.sip]
```

```
progress_if_media=0/1/2 [default=2]
```

To see how this parameter interacts with others for an FXS interface, see table in [13.6.3.5 "FXS SIP parameters for ringback generation to the VoIP interface"](#)

To see how this parameter interacts with others for an ISDN interface see table in [13.6.3.6.1 "](#)

[ISDN SIP parameters for ringback generation to the VoIP interface](#)**13.6.3.3 Network (Remote) Call Progress Tones (SIP gateways only)**

It is possible to configure a SIP Vega to generate call progress tones that are played back over the LAN, for scenarios where it is not possible to generate the progress tones at the "local" end.

**13.6.3.3.1 Tone Types**

When configured (see section [13.6.3.3.5 "Configuration Parameters for Network Tones \(SIP only\)"](#)) there are 3 kinds of tones that can be played:

- 1) **ringback** - normal ringback tone
- 2) **failure** - tone played when call couldn't be made e.g. due to "engaged" or "unreachable"
- 3) **disconnect** - tone played when call was hung-up at the far end first.

**13.6.3.3.2 Ringback Tone**

For example, when a user A makes a VoIP call to / through the Vega, he / she can hear the ringback tone generated by the remote Vega.

```
User A on           User B on
SIP phone-----LAN-----Vega
                    <----- (sends ringback using RTP)
```

**13.6.3.3.3 Failure Tones**

For example, remote user engaged:

- 1) User A calls User B.
- 2) User B is engaged.
- 3) User A hears the busy tone generated by the Vega.

```
User A on           User B on
SIP phone-----LAN-----Vega
                    <----- (sends busy tone using RTP)
```

**13.6.3.3.4 Disconnect Tones**

For example, remote user hangs up first:

- 1) User A calls User B.
- 2) User B answers and then hangs up
- 3) User A hears the busy tone generated by the Vega

```
User A on           User B on
SIP phone-----LAN-----Vega
                    <----- (sends busy tone using RTP)
```



### 13.6.3.3.5 Configuration Parameters for Network Tones (SIP only)

Network tones are enabled using the following parameters:

[ tones.net ]

ring=1 ;set to '1' to enable playing of ringback tone towards packet network

The tones definitions used for the Network call progress tones are:

Network tone	Use tone defined by
Ringback	tones.ringback_seq
Failure	tones.busytone_seq
disconnect	tones.busytone_seq

### 13.6.3.4 Vega FXO ringback\_present

The `ringback_present` parameter is designed for use on line current reversal lines to control whether during outdial the calling party hears ringback tone, or whether they hear the dial tone, outdial and any progress tones.

[ \_advanced.pots.fxo.x ]

ringback\_present=0/1 [default=1]

If `ringback_present=0`, on an FXO outbound call ringback tone is passed to the VoIP interface until the FXO answer is received

If `ringback_present=1`, on an FXO outbound call, audio from the FXO line is passed across the VoIP interface as soon “early media” allows audio to be transferred

NOTE

On standard loopstart lines, the “answer” occurs on seizing the FXO line, so all dialling etc. will be heard whatever the value of this parameter. On line current reversal lines ringback tone will be heard until answer if this parameter is set to 0.

### 13.6.3.5 FXS SIP parameters for ringback generation to the VoIP interface

The following table shows the interaction of various parameters with the generation of ringback tone to the SIP interface.

Tones.net.ring	advanced.sip.progress_if_media	Result
Generate ringback tone to packet network when Alerting	0: Force use of 180 if alerting 1: Use 183 rather than 180 if media present in alerting 2: Use 183 if either in-band or locally generated media	
0	0	180 (no sdp)
	1, 2	183 (no sdp)
1	0, 1	180 with sdp; Locally generated ringback
	2	183 with sdp; Locally generated ringback

### 13.6.3.6 ISDN

Configuration parameters are available to allow control over the playing of dial tone and in-band progress tones from the Vega.

NOTE
------

DSLs configured as NT generate dial tone and progress tones by default, but `_advanced.isdn.force_disconnect_progress` still needs to be configured to define the maximum time to play disconnect tone at the end of a call.

**[\_advanced.isdn]**

`user_dialtone=0/1`

[default=0]

set to 1 configures TE E1T1s on ISDN interfaces to originate dial tone towards an NT device.

**[\_advanced.isdn]**

`user_progress=0/1`

[default=0]

set to 1 configures TE E1T1s on ISDN interfaces to originate progress tones towards an NT device, for both DISCONNECT and ALERTING messages.

**[\_advanced.isdn]**

`alert_with_progress=0/1/2`

[default=1]

Set to 0 causes the Vega to ignore any 'In-band Media' indication in ISDN Alerting messages (media is not cut through at this stage)

Set to 1 causes the Vega to act upon any 'In-band Media' indication in ISDN Alerting messages (media is cut through if in-band media is indicated)

Set to 2 causes the Vega to Assume 'In-band Media' on receiving an ISDN Alerting message (media is cut through immediately after the Alerting message has been received).

**[\_advanced.isdn]**

`progress_with_progress=0/1/2`

[default=1]

Set to 0 causes the Vega to ignore any 'In-band Media' indication in ISDN Progress messages (media is not cut through at this stage)

Set to 1 causes the Vega to act upon any 'In-band Media' indication in ISDN Progress messages (media is cut through if in-band media is indicated)

Set to 2 causes the Vega to Assume 'In-band Media' on receiving an ISDN Progress message (media is cut through immediately after the Progress message has been received).

**[\_advanced.isdn]**

send\_progress\_as\_alerting=0/1 [default=0]

Set to 0 allows progress messages to be passed through unchanged

Set to 1 causes received progress messages from ISDN interfaces to be converted to alerting messages before being forwarding onto the VoIP interface or another ISDN interface.

### 13.6.3.6.1 ISDN SIP parameters for ringback generation to the VoIP interface

The following table shows the interaction of various parameters with the generation of, or passing through of ringback tone to the SIP interface.

ISDN messaging	_advanced.isdn.alert_with_progress	_advanced.isdn.progress_with_progress	_advanced.isdn.send_progress_as_alerting	Tones.net.ring	_advanced.sip.progress_if_media	Result
	Alert message with Progress Indicator 0: do not pass media through 1: pass through media if in-band media indicated 2: assume media is present and pass it through even if not indicated in signalling	Progress message with Progress Indicator 0: do not pass media through 1: pass through media if in-band media indicated 2: assume media is present and pass it through even if not indicated in signalling	Treat an incoming ISDN progress message as though it were an Alerting message.	Generate ringback tone to packet network if Alerting or Progress is received, provided that no media is indicated.	0: Force use of 180 if alerting 1: Use 183 rather than 180 if media present in original ISDN alerting or progress message 2: Use 183 if either in-band media or locally generated media is present	
Alerting (no media)	0, 1	X	X	0	0	180 (no sdp)
					1, 2	183 (no sdp)
	2	... As Alerting (with media)	1	180 with sdp; Generated ringback		
			2	183 with sdp; Generated ringback		
Alerting (with media)	0, 1, 2	X	X	X	0	180 with sdp; ISDN media
					1, 2	183 with sdp; ISDN media
Progress (no media indicated)	X	0, 1	0	0	X	180 (no sdp)
					1	180 with sdp; Generated ringback
	2	As Progress (with media)	1	183 with sdp; Generated ringback		
			As Alerting (no media)			
Progress (with media)	0	0	0	X	X	180 (no sdp)
		1, 2	0	X	X	183 with sdp; ISDN media
		X	1	... As Alerting (no media)		
	1, 2	0	0	X	X	180 (no sdp)
		1, 2	0	X	X	183 with sdp; ISDN media
		X	1	... As Alerting (with media)		

### 13.6.3.7 CAS SIP parameters for ringback generation to the VoIP interface

The following table shows the interaction of various parameters with the generation of ringback tone to the SIP interface.

On setting up a call, after the CAS dialling is complete the Vega CAS code sends a progress message – with no media indication – to SIP.

e1t1.port.x.rbs.progress_tones_present	tones.net.ring	Result
0: Indicate no progress tone 1: Indicate progress tone	Generate ringback tone to packet network when Alerting or Progress is received, provided that no media is indicated.	
0	0	180 (no sdp)
	1	183 with sdp: Generated ringback
1	x	183 with sdp: CAS media

### 13.7 Symmetric RTP / Dynamic RTP

Symmetric RTP / Dynamic RTP allows the Vega to be configured so that it monitors the incoming audio RTP stream for a call and makes sure that the RTP it sends out is sent back to that same IP address as the media is received from. This helps traverse firewalls where the sender does not properly define the outside IP address of the firewall in its SIP sdp.

Receiving RTP audio data from an IP port and / or IP address that is different from that indicated in the SDP is not a problem for the Vega receiving the RTP traffic. If however the Vega sends its RTP traffic back to the originator using the IP address / IP port specified in the SDP it is unlikely to get through the NAT as the NAT will only route data back to the sender if it is received on the same IP address / IP port that the RTP traffic is sent from.

In order to handle this, it is necessary for the Vega receiving the RTP to detect the IP port / IP address that it is receiving the RTP traffic from and return the RTP traffic back to that IP port / IP address.

#### [media.control.1.dynamic\_update]

```
enable=1                ; enable
frequency=n             ; a value of 0 means that only the first received RTP
                        ; packet will be checked. A value of 1 means that every
                        ; packet will be checked, a value of 2 means that every
                        ; other packet will be checked ...
ip_follow=1             ; set to 1 to allow IP address and IP port following
private_subnet_list_index=0 ; defines list of allowable IP addresses to follow
```

#### NOTE

If Symmetric RTP is needed, audio cannot be received by the device whose RTP is being NATed differently from that defined in the SDP, until the far end has received RTP traffic from that device (as it is not until the RTP traffic is received that the returned RTP traffic can be sent to the correct IP port / IP address). This means that early audio may be lost – as initially it will be sent to the wrong destination IP port / IP address (the IP port / IP address specified in the SDP).



#### WARNING!

**Checking every packet for a change of IP details is processor intensive – benchmark your system if you set dynamic\_update\_freq to anything other than zero**

## 14 FAX, MODEM AND DATA CALLS

### 14.1 Fax and Modem Operation

In the same way that DTMF tones can be compressed so much that when uncompressed they are out of specification, so can group 3 fax and modem transmissions. This causes fax / modem tone recognition problems and therefore failed fax / modem calls.

Vega gateways support both T.38 and G.711 up-speeding to allow fax and modem calls to succeed:

- T.38 is an ITU-T standard defining how to carry group 3 fax transmissions as out of band packets over an IP network (this only supports fax communications, it does not support direct modem communications).
- Super G3 faxes – using modem signalling > 33 kbps – and non-fax modems require connection via G.711.

Call flow:

Vega gateways will always connect initially using the preferred voice codec. If fax or modem detection is enabled (see below for details) then the Vega will monitor for these in-band tones.

When detected, depending on the configuration of the Vega and the tones heard (modem and fax, or just modem) the Vega will connect using T.38, or up-speed to a data mode G711 codec.

NOTE

1. As per the standards:  
H.323 Vega gateways support both TCP and UDP T.38  
SIP Vega gateways support UDP T.38 (SIP Annex D T.38)  
and also SIP Annex E (voice and fax codec negotiated so  
no re-invite needed)
2. Once switched to T.38 mode the Vega will not automatically  
revert back to voice mode (it needs a VoIP request to  
change back to a voice codec).
3. Vega gateways support connection rates up to 14.4 kbps  
when using T.38 (faster connection rates require G.711  
data mode)

*For further details on the T.38 protocol see Information Note IN\_06-T38 protocol interactions.*



**If you have problems getting fax / modem communications working look out for the following Gotchas:**

1. Delays introduced by the data network can create problems with the fax handshaking. This is because, although tones are detected and regenerated at the VoIP gateways, the handshaking is passed between the end fax machines.
2. If the clocking of the source and destination VoIP gateways is not synchronised by say connection of the gateways to digital trunks on the PSTN, then they will run at

independent clock speeds. Over time, internal buffers will overflow or underflow due to the difference in clock (data) rates. This will cause the fax machines / modems to have to re-negotiate. If the slip is too great then re-negotiation will take more time than data transmission time and connections are likely to fail.

#### 14.1.1 SIP handling of Fax and modem calls

Fax machines and modems only send tones once a call is in progress, so initially a VoIP call will be set up using a codec specified in `media.capset.x.caps`. If fax and modem detection is enabled the Vega will then monitor for fax and modem tones. If they are detected, the Vega will do its best to get the fax / modem call through to the destination, by using either T.38, if enabled, and if it is supported by the other endpoint device (and the call is a fax call), otherwise using a G.711 data codec (g.723.1 and G.729 will not pass fax or modem calls).

On detecting the fax tones the Vega first sends a Re-INVITE to the other SIP device with T.38 in the SDP. If the other end cannot support T.38 then it will reject this Re-INVITE and the Vega will send another Re-INVITE, this time offering to use G.711U-law and G.711A-law.

If both Re-INVITE's are rejected then the call will be terminated.

If the call is a modem call the INVITE with T.38 will be omitted.

If SIP Annex E is enabled (`sip.t38_annexe_use / sip.t38_annexe_accept`) and agreed during sdp negotiation, then the re-invite stage is omitted; when the fax call is detected the media can be swapped to T.38 immediately.

Some endpoints are sensitive to the SIP header information supplied when making T.38 connections – if problems occur, try making the following Vega parameter changes:

```
[_advanced.sip.sdp]
  sess_desc_connection=1
  t38_single_media=1
```

Some fax machines have integrated phone handsets. If a voice call is made between two such machines (and the call is routed via a VegaStream gateway over SIP), then a FAX is sent on the same call; if the handsets remain off-hook the two parties can talk to one another again after the FAX call has been sent.

This will result in the Vega transmitting a further SIP re-INVITE to switch back to a voice codec.

*For more details on the operation of the T.38 protocol see IN\_06-T38 protocol interactions.*

#### 14.1.2 H.323 handling of Fax and modem calls

Fax machines and modems only send tones once a call is in progress, so initially a VoIP call will be set up using a codec specified in the `media.capset.x.caps`. Typically this capset will be the 'faststart' capset and will not include any fax or modem codecs. If the Vega detects any fax / modem tones and the 'non-faststart' capset includes any fax / modem handling codecs, the Vega will do its best to get the fax / modem call through to the destination, by using either T.38 (tcp or udp – whichever is enabled), if it is supported by the other endpoint device (and the call is a fax call), otherwise using a G.711 data codec (g.723.1 and G.729 will not pass fax or modem calls).



On detecting fax or modem tones the Vega closes the voice 'logical channel' and starts media negotiations to open the relevant T.38 and / or G.711 'logical channel' (whichever is included in the non-faststart capset).

If this new media negotiation fails then the call will be terminated.

Some gateways (like Vega gateways) allow T.38 to be included in the original faststart. It is possible that both a voice and a T.38 channel will be accepted. Under this condition, there is no need to re-negotiate codecs when fax is detected, fax media will just be sent down the T.38 logical channel, and voice media will no longer be sent down the voice channel when fax is detected.

NOTE
------

When using T.38 use of `fast_start` is not mandatory, in fact VegaStream's recommended configuration is to enable `early_h245` and disable `fast_start`

*For more details on the operation of the T.38 protocol see IN\_06-T38 protocol interactions.*

## 14.2 Configuration Parameters for fax / modem handling

```
[sip]
  enable_modem=1                ; Allow low speed modems to be detected and
                                ; up-speed to G.711 instead of using T.38
  fax_detect=terminating        ; At which end of the VoIP link should fax
                                ; tones be looked for
  modem_detect=terminating      ; At which end of the VoIP link should
                                ; modem tones be looked for
  T38_annexe_accept=0           ; Accept T.38 Annex E requests
  T38_annexe_use=0              ; Initiate T.38 Annex E requests

[dsp.t38]
  cd_threshold=-33              ; Threshold for Carrier Detect signal (db)
  FP_FIFO_nom_delay=300        ; Fax Play-out FIFO nominal delay (ms)
  network_timeout=150          ; Time before clear-down if packets stop
  packet_time=40                ; Packet size in milliseconds
  rate_max=144                  ; Max fax rate bps/100
  rate_min=24                   ; Min fax rate bps/100
  rate_step=24                  ; Step size in fax rates
  timeout=15                    ; No Activity timeout
  tx_level=-8                   ; Fax Modem Transmit Level (0:-13dB)

[media.packet.t38tcp.x]
  max_rate=144                  ; Preferred max fax rate bps/100
  tcf=local                      ; T.38 fax training mode

[media.packet.t38udp.x]
  max_rate=144                  ; Preferred max fax rate bps/100
  tcf=transferred                ; T.38 fax training mode

[_advanced.dsp]
  fax_disconnect_delay          ; Delay after receiving disconnect before
                                ; clearing call
  t38_diags=0                   ; For engineering use only

[_advanced.dsp.buffering.fax]
  depth=100                      ; Buffer size
  enable=0                       ; Enable T.38 packet re-synch in buffer
```

```

[_advanced.media]
  control_v25 = fax                ; Force to fax mode if V25 tone is heard

[_advanced.t38]
  allow_MR_page_compress=1        ; Do not suppress use of MR page
                                   ; compression
  allow_ecm=1                      ; Do not suppress Error Correction Mode
  enable_Eflags_in_first_DIS=1    ; For Engineering use only
  enable_TFoP=1                    ; Do not disable repetition of
                                   ; FrameComplete packet
  enable_scan_line_fix_up=1        ; Do not disable scan line fix-up

[_advanced.t38.tcp] (H323 Only)
  collect_hdlc                     ; Collect V.21 hdlc into packets
  connect_on_demand=1              ; Connect T.38 when fax tones are detected
                                   ; (rather than on every call)
  port_range_list=2                ; _advanced.lan.port_range_list that
                                   ; specifies t38 tcp ports
  suppress_t30=0                   ; Suppress transmission of some T.30
                                   ; indications

[_advanced.t38.udp]
  check_start_packet=1             ; Only switch to fax mode when first fax
                                   ; packet has been received (allowing voice
                                   ; path to remain connected to that point)
  port_range_list=3                ; _advanced.lan.port_range_list that
                                   ; specifies t38 udp ports

```

H.323 Vega gateways treat TCP T.38 and UDP T.38 as codec types. Enabling T.38 is carried out in the same manner as enabling audio codecs; see section [13.1.4 "Defining Fax capabilities"](#).

SIP gateways treat UDP T.38 as a codec type. Enabling T.38 is carried out in the same manner as enabling audio codecs; see section [13.1.4 "Defining Fax capabilities"](#).

More details on some of the key parameters:

```

[media.packet.t38tcp.x] (H323 only)
  tcf

```

The `tcf` parameter defines whether fax modem training is carried out at the local ends of the VoIP link, or whether the training tones should be transferred across the VoIP link – for t38 tcp recommendations say keep training local

It is important that this value is configured the same at both ends of the VoIP call.

```

[media.packet.t38udp.x]
  tcf

```

The `tcf` parameter defines whether fax modem training is carried out at the local ends of the VoIP link, or whether the training tones should be transferred across the VoIP link – for t38 udp recommendations say transfer the training information across the VoIP link

It is important that this value is configured the same at both ends of the VoIP call.

```

[sip]
  enable_modem

```

If `enable_modem` is set to 0, then the Vega will not support low speed modems; it will treat any call which has low speed modem tones as a fax call. This setting can be used if it is known that all calls will be voice or fax calls and not modem calls.

If `enable_modem` is set to 1, then, on hearing low speed modem tones, the Vega will assume that the call is a low speed modem call (and use G.711 rather than T.38) unless it detects the V.21 tone which confirms that the call is a fax call.

If `enable_modem` is set to 1, then even if G711 data codecs are not enabled in the active `media.capset.n.caps` they may still be used.

```
[sip]
    fax_detect
    modem_detect
```

The `fax_detect` and `modem_detect` parameters defines whether the Vega looks for fax and / or modem tones: only from its telephony interface, from telephony and VoIP interfaces, or never.

It is generally better (and adheres to the standards) to only detect tones on one end of the call – the end terminating the VoIP call (initiating the call to the answering fax machine / modem); this is the end that hears the tones directly from the line (rather than having to detect tones that have passed through both the telephone line and through VoIP). If the far end 3<sup>rd</sup> party gateway does not detect the tones properly the Vega can be configured always to detect fax / modem tones, whether the call arrives on the Vega on its telephony interface or its VoIP interface.

```
[sip]
    T38_annexe_accept
    T38_annexe_use
```

T.38 Annex E allows media to change from Voice to T.38 without need for a re-invite. This speeds up the transition from voice mode to fax mode, and reduces the number of signalling messages required.

```
[_advanced.media]
    control_v25
```

Setting `v25_control` to `data` causes the Vega to use G711 data codecs rather than T.38 for transmission of modem and fax calls.

```
[_advanced.dsp.buffering.fax]
    depth                ; Buffer size
    enable                ; Enable T.38 packet re-synch in buffer
```

By default Vega gateways expect to see T.30 / T.38 messages arriving in sequence. With certain gateways (e.g. Cisco) the messages are not always sent out sequentially. By enabling `_advanced.dsp.buffering.fax` the Vega can handle this. It re-orders the T.30 / T.38 messages into sequential order as it puts them in the buffer.

For details about other parameters, see the information in [6.7 “Configuration Entries”](#), and [6.8 “Advanced configuration entries”](#).

#### 14.2.1 Recommended Values For SIP FAX / Modem Connectivity

For normal use with FAX and modems:

1. Enable the required audio codecs in the capset. Add T38udp, followed by one or both G711Alaw 64k – profile 2 and / or G711ulaw64k – profile 2.
2. `set sip.enable_modem = 1`
3. `set _advanced.media.control_v25 = ignore`

For use with G.711 Up-Speeding only, and no T.38:

1. Enable the required audio codecs in the capset. Add one or both G711Alaw 64k – profile 2 and / or G711ulaw64k – profile 2.
2. `set sip.enable_modem = 1`
3. `set _advanced.media.control_v25 = data`

For use with T.38 only, and no G711 Up-Speeding:

1. Enable the required audio codecs in the capset, add T38udp as the last entry.
2. `set sip.enable_modem = 0`
3. `set _advanced.media.control_v25 = fax`

### **14.3 ISDN Unrestricted Digital Information Bearer Capability And Clear Mode**

ISDN calls are tagged with a bearer capability identifying the type of media being carried. For standard Voice and fax calls, bearer capabilities of 'voice' and '3.1KHz audio' are usually used.

One of the other bearer capabilities is Unrestricted Digital Information. In order to carry this type of media, standard voice compression / gain must not be applied. SIP variants of Vega code automatically force the codec type to use to clear mode when Unrestricted Digital Information calls are received.

Clear mode (also known as octet codec) can also be specified in the capset to be used in cases where a bearer capability is not available or the one received does not specify Unrestricted Digital Information.

## 15 SIP GATEWAYS

This section describes the configuration and behaviour of SIP variants of the Vega gateway.

### 15.1 Introduction

The SIP firmware acts as a set of SIP User Agents within the Vega. Communication, by default, is via UDP unicast, usually to and from UDP port 5060. TCP connection for SIP signalling messages may also be configured. (Note audio – RTP – traffic is always UDP).

All Request URI usernames are of the form `sip:telephone_number` and all hosts are expressed as numerical IP addresses, or domain names if DNS is configured, in which case `lan.name` must be set to the Vega's DNS hostname.

The SIP module supports remote commands for re-INVITE, hold and retrieve, transfer via the BYE-Also mechanism and also the REFER method.

Calls are accepted either solely from a designated default proxy (or from its backups), or from any source, depending on a configuration option.

Calls are routed between the telephony interfaces and the SIP module by means of dial plans. The SIP module being represented by the default interface ID of '99'.

The module may be configured to provide reliable provisional responses (PRACK) when receiving the Require: or Supported: headers. The module may also be configured to request reliable provisional responses using the Require:100rel or Supported:100rel.

For FXS units, the SIP module also includes mechanisms for handling Flash-hook, DTMF, call waiting, message waiting and distinctive ringing.

Vegas also feature the ability to generate tones toward the network and an off-hook warning tone towards a phone.

All Vega gateways may be configured to register with a registration server (typically part of the proxy).

All Vega gateways also support Authentication on Registration, INVITE, ACK and BYE messages.

### 15.2 Monitor Commands

```
SIP MONITOR ON
```

```
SIP MONITOR OFF
```

Control the display of the SIP signalling monitor. The monitor is useful for checking the operation of the SIP module. The monitor displays each SIP message sent or received, headed by an output line in the following form:

```
SIP m:System_elapsed_time(ms) delta_time(ms) message_number <-- RX/TX --- From/To
IP_address:Port
```

## 15.3 Registration Status Commands

Registration is supported on all Vega gateways.

Please Refer to sections [15.4.4 “Registration”](#), and [15.4.5 “Authentication”](#) for setup details.

By default Vega gateways are configured not to register by default, but FXS ports and FXO ports have registration entries configured and disabled so that they are easy to enable.

The console registration status and registration commands are:

```
* SIP SHOW REG
* SIP SHOW REG [user]
* SIP REG user
* SIP REG ALL
* SIP CANCEL REG user
* SIP CANCEL REG ALL
* SIP RESET REG
```

### 15.3.1 SIP SHOW REG

Use this command to display the current registration state of all SIP registration users.

Syntax	SIP SHOW REG
<b>Behaviour:</b>	<p>Displays the current registration state of ALL records as in the following example:</p> <pre>----- domain          = abcdefghijwhatever.com expiry          = 600 -----  SIP REG USER 1 --- address - sip:01@abcdefghijwhatever.com --- auth user auth user disabled --- contact - sip:01@172.16.30.31 --- state   - registered --- TTL    - 500 seconds  SIP REG USER 2 --- address - sip:02@abcdefghijwhatever.com --- auth user auth user disabled --- contact - sip:02@172.16.30.31 --- state   - registered --- TTL    - 480 seconds ... </pre>

### 15.3.2 SIP SHOW REG [user]

Syntax	<p>SIP SHOW REG [user]</p> <p>user – optional parameter to specify which user's details you wish to see.</p>
--------	--------------------------------------------------------------------------------------------------------------

<b>Example</b>	SIP SHOW REG 1
<b>Behaviour</b>	Vega displays the registration status of the users / all users

### 15.3.3 SIP REG user

<b>Syntax</b>	SIP REG user
<b>Example</b>	SIP REG 1
<b>Behaviour</b>	Vega sends a "register user" message to the registration server for the specified user.

### 15.3.4 SIP REG ALL

<b>Syntax</b>	SIP REG ALL
<b>Behaviour</b>	Vega sends "register user" messages to the registration server for ALL users.

### 15.3.5 SIP CANCEL REG user

<b>Syntax</b>	SIP CANCEL REG user
<b>Example</b>	SIP CANCEL REG 1
<b>Behaviour</b>	Vega sends a "cancel registration" message to the registration server for the specified user.

### 15.3.6 SIP CANCEL REG ALL

<b>Syntax</b>	SIP CANCEL REG ALL
<b>Behaviour</b>	Vega sends "cancel registration" messages to the registration server for ALL users.

### 15.3.7 SIP RESET REG

<b>Syntax</b>	SIP RESET REG
<b>Behaviour</b>	Vega cancels all current registrations and re-registers the updated user details with the registration server (used on re-configuration of registration details).

## 15.4 SIP Configuration

SIP configuration is performed in the SIP subsection of the configuration database. This can be accessed via a web browser or via the command line interface. The following notes refer to the command line interface procedures.

### 15.4.1 TCP / UDP SIP

The Vega can be configured to send SIP signalling messages using UDP, TCP or TLS. This is configurable on a per SIP profile basis:

```
[sip.profile.1]
  sig_transport=udp      ; udp, tcp or tls
```

UDP has been part of the SIP standards for longer, and so if the Vega is configured for TCP operation and it cannot get a TCP connection it will revert back to UDP for that call.

SIP over TLS is an optional addition to the standard featureset and requires a special license to enable. TLS (Transport Layer Security) secures the TCP/IP connection and hence secures the SIP messaging.

### 15.4.2 Proxy

Vega gateways can be configured to operate with SIP Proxy servers. This is a common configuration, especially where advanced features, like follow me, conferencing or voice mail are required. Also where centralisation of the configuration of routing data is required, or connection to an ITSP (Internet Telephony Service Provider) is required.

A proxy sever is a device to which the Vega can send SIP call traffic.

The parameter `sip.profile.x.proxy.y.ipname` is used to define the IP address of the proxy server that you wish the Vega to communicate with (i.e. where to send the INVITE messages to).

The proxy IP address may be defined either as a dotted decimal value, e.g. `aaa.bbb.ccc.ddd` or: as a DNS name, e.g. `sip.vegastream.com`

NOTE
------

If SIP calls are to be sent to destinations other than the Proxy, the TA: token in the dial planner can be used to override the destination IP address.

#### 15.4.2.1 Multiple SIP Proxy Support

Vega gateways support the ability to use more than 1 proxy for redundancy and for load balancing purposes. Either multiple alternative SIP proxies can be defined through use of a list of proxies, or multiple alternative SIP proxies can be defined through use of DNS SRV records on a single DNS SRV name.

##### 15.4.2.1.1 Multiple SIP Proxy Configuration

The configuration parameters used in "multiple proxy support" are:

```
[sip.profile.x.proxy]
  min_valid_response=180      ; Once the Vega receives a SIP message
                               response whose ID >= value specified by this
                               parameter, it knows that the proxy is "up" and the
                               Vega will not try other proxies in the list (i.e. any
                               SIP responses with a value less than
                               "min_valid_response" will be ignored by the
                               "multiple proxy support" module). The exception
```



```

mode=normal ; to this rule is when 5xx responses (e.g. "500
              internal server error") are received. In such a
              case, the INVITE will be sent to the next backup
              proxy immediately.
              ; the mode parameter defines how the Vega
              should handle the alternate proxies:
              normal ... use the first proxy in list that responds
              with a valid response
              cyclic ... for each call try the next proxy in the list
              dnssrv ... abide by the dnssrv proxy list and
              weighting (Vega only uses first proxy entry)
timeout_ms=5000 ; if the Vega does not receive a "minimum valid
                 response" to an INVITE within the time specified
                 by this parameter, then the Vega will try the next
                 proxy in the list.

Determining whether the proxy is available to use ...
accessibility_check=off ; off: Only treat proxy as failed if SIP timeouts fail
                        the call – then use alternate proxy for that call
                        options: Treat proxy as failed if SIP OPTIONS
                        messages are not responded to by the proxy
                        (use alternate proxy for all calls until OPTIONS
                        messages are responded to again)
                        BYE: Same behaviour as "options" but uses SIP
                        BYE messages to poll proxy availability.

accessibility_check_transport=udp ; Specify whether to use udp or tcp to send
                                   OPTIONS messages to the proxy (to see if it is
                                   alive)

retry_delay=0 ; When a proxy is deemed to have failed and the
               Vega switches to using an alternate proxy, this
               timer specifies how long to wait before trying that
               failed proxy again (allowing the proxy time to
               recover and minimising the delay on future
               phone calls ... they do not have to time out
               before being routed using the alternative proxy)

[sip.profile.x.proxy.1] ; first proxy / DNS SRV name
  enable=1 ; 1 = enable requests to this proxy
  ipname=136.170.208.134 ; the IP address or resolvable DNS name of the
                        backup proxy
  port=5060 ; the port to use for this proxy (not used when
            mode = dnssrv as dnssrv supplies IP port)

[sip.profile.x.proxy.2] ; second proxy
  enable=1
  ipname=hello.com
  port=5060

[sip.profile.x.proxy.3] ; third proxy
...etc

```

NOTE

The default value chosen for `min_valid_response` is 180 (ringing) – because it means that the call is REALLY progressing.

A value of say 100 (trying) could be used – this would indicate that the proxy is alive, but it only indicates that the proxy received the message - it doesn't necessarily mean that the proxy has done anything useful with it.

NOTE

Configuring a registrar and alternatives follows the same methodology as configuring the proxy and alternatives

#### 15.4.2.1.2 Commands associated with Multiple SIP proxies

➤ `new sip.profile.x.proxy`

Adds a new entry

➤ `delete sip.profile.x.proxy.n`

Deletes an entry

NOTE

You can only delete the last `backup_proxy.n` in the `backup_proxy` list.

#### 15.4.2.1.3 Examples of “Multiple Proxy Support” Operation – Normal mode

##### 1. Single proxy operation

Vega simply sends INVITE to the default proxy e.g.:

```
Vega----INVITE---->136.170.208.133      (sip.profile.x.proxy.1.ipname)
```

##### 2. Operation with two proxies

Vega starts by sending the INVITE to the default proxy e.g.:

```
Vega----INVITE---->136.170.208.133      (sip.profile.x.proxy.1.ipname)
```

If the default proxy does not respond with at least a `min_valid_response` (typically=180) message within `backup_proxy.timeout_ms` (e.g. 5000ms) then the Vega will send out a new INVITE to the second proxy.

```
Vega----INVITE---->136.170.208.134      (sip.profile.x.proxy.2.ipname)
```

If the second proxy responds with at least a `min_valid_response` message within `backup_proxy.timeout_ms` then the Vega will try to cancel the INVITE to the default proxy.

```
Vega<----100 Trying----136.170.208.134    (sip.profile.x.proxy.2.ipname)
```

```
Vega<----180 Ringing----136.170.208.134  (sip.profile.x.proxy.2.ipname)
```

```
Vega-----CANCEL----->136.170.208.133      (sip.profile.x.proxy.1.ipname)
```

### 3. Operation with three proxies

Vega starts by sending the INVITE to the default proxy e.g.:

```
Vega----INVITE---->136.170.208.133      (sip.profile.x.proxy.1.ipname)
```

If the default proxy does not respond with at least a `min_valid_response` (typically=180) message within `backup_proxy.timeout_ms` (e.g. 5000ms) then the Vega will send out a new INVITE to the second proxy.

```
Vega----INVITE---->136.170.208.134      (sip.profile.x.proxy.2.ipname)
```

If the second proxy also does not respond within `backup_proxy.timeout_ms`, then the Vega will send out a new INVITE to the third proxy.

```
Vega-----INVITE----->136.170.208.200    (sip.profile.x.proxy.3.ipname)
```

If the third proxy responds with at least a `min_valid_response` message within `backup_proxy.timeout_ms` then the Vega will try to cancel the INVITE to the default proxy and second proxies.

```
Vega<----100 Trying----136.170.208.200    (sip.profile.x.proxy.3.ipname)
```

```
Vega<----180 Ringing----136.170.208.200  (sip.profile.x.proxy.3.ipname)
```

```
Vega-----CANCEL----->136.170.208.133    (sip.profile.x.proxy.1.ipname)
```

```
Vega-----CANCEL----->136.170.208.134    (sip.profile.x.proxy.2.ipname)
```

### 4. Operation with three proxies (2<sup>nd</sup> proxy returns with a server error)

Vega starts by sending the INVITE to the default proxy e.g.:

```
Vega----INVITE---->136.170.208.133      (sip.profile.x.proxy.1.ipname)
```

If the default proxy does not respond with at least a `min_valid_response` (typically=180) message within `backup_proxy.timeout_ms` (e.g. 5000ms) then the Vega will send out a new INVITE to the second proxy.

```
Vega----INVITE---->136.170.208.134      (sip.profile.x.proxy.2.ipname)
```

If the second proxy responds with a server error, then the Vega sends a new INVITE to the third proxy (immediately – not waiting the `backup_proxy.timeout_ms` delay).

```
Vega<--501 Server Error--136.170.208.134 (sip.profile.x.proxy.2.ipname)
```

```
Vega-----ACK----->136.170.208.134    (sip.profile.x.proxy.2.ipname)
```

```
Vega----INVITE---->136.170.208.200    (sip.profile.x.proxy.3.ipname)
```

Once the proxy responds with a 180 message the Vega will tries to cancel any other outstanding INVITE.

```
Vega<----100 Trying----136.170.208.200 (sip.profile.x.proxy.3.ipname)
Vega<----180 Ringing----136.170.208.200 (sip.profile.x.proxy.3.ipname)
Vega-----CANCEL----->136.170.208.133 (sip.profile.x.proxy.1.ipname)
```

The Vega does not need to CANCEL the INVITE to the second proxy because the transaction has already been completed with the "501 Server Error" and "ACK" response

#### 15.4.2.1.4 Examples of "Multiple Proxy Support" Operation – Cyclic mode

If

```
[sip.profile.x.proxy.1]
  default_proxy=200.100.50.1

[sip.profile.x.proxy.2]
  enable=1
  ipname=200.100.50.2

[sip.profile.x.proxy.3]
  enable=1
  ipname=200.100.50.3
```

on the first call after power-up, the Vega would try the SIP proxy at 200.100.50.1 and then, if there was no response, 200.100.50.2, and then 200.100.50.3.

On the second call, the Vega would first try the SIP proxy at 200.100.50.2 (the 2<sup>nd</sup> proxy) and then, if there was no response, 200.100.50.3, and then 200.100.50.1.

Then, on the third call, the Vega would first try the SIP proxy at 200.100.50.3 (the 3<sup>rd</sup> proxy) and, if there was no response, 200.100.50.1, and then 200.100.50.2.

And on the fourth call 4, the Vega would start again with the default proxy (as per the first call).

This "cyclic" mode provides a primitive form of load-balancing of calls over the listed proxies.

### 15.4.3 SIP SDP 'a=' ptime and direction attributes

#### 15.4.3.1 Ptime attribute in SDP

In SIP SDPs a codec Packet Time (ptime) may be requested / specified. Control over whether the Vega will ignore and not generate ptime requests, or whether it will act upon and generate ptime parameters is controlled by the parameter:

```
[_advanced.sip.sdp]
ptime_mode                ; 0=ignore /do not generate ptime,
                           ; 1=act upon and generate ptime
                           ; mptime
                           ; x_mptime
                           ; ptime 30
                           ; ptime60
```

If `ptime_mode=0` then the Vega will neither create, nor respond to ptime requests.

If `ptime_mode=1` then the Vega will create and respond to ptime requests based on its codec capabilities.

Vegas support the following codecs and packet times:

```
G.729 - 10, 20, 30, 40, 50, 60, 70 or 80ms
G.711a - 10, 20 or 30ms
G.711u - 10, 20 or 30ms
G.723.1- 30 or 60ms
```

1) If the Vega receives an INVITE including a codec and ptime that it supports, it will honour the ptime and respond with that codec and the ptime in its returning the SDP

For example:

```
<--Invite:
m=audio 10000 RTP/AVP 0 --- G.711 u-law
a=ptime:20

-->Ringin/OK
m=audio 10000 RTP/AVP 0 --- G.711 u-law
a=ptime:20
```

2) If the incoming INVITE does not specify the ptime, the Vega will inform the originator of its choice by supplying the ptime in its SDP.

For example:

```
<--Invite:
m=audio 10000 RTP/AVP 0 --- G.711 u-law

-->Ringin/OK
m=audio 10000 RTP/AVP 0 --- G.711 u-law
a=ptime:30
```

3) If the Vega cannot honour the requested ptime, it responds with a 488 error (Not Acceptable Here) and specifies the unsupported ptime.

For example:

```
<--Invite:
m=audio 10000 RTP/AVP 0 --- G.711 u-law
a=ptime:950

-->488 audio ptime 950ms unsupported or unobtainable
```

There will also be a log message:

```
LOG: 14/03/2003 09:56:43.660 SIP (I)Rd3C00 unsupported/unobtainable
packet time (950 ms)
call ref=[f100001f]
```

4) If G723 is requested, the Vega forces a ptime based on the value configured in `media.packet.g7231.y.packet_time`, regardless of the original request.

For example if `...packet_time=30`:

```
<--Invite:
m=audio 10000 RTP/AVP 4 --- g723
a=ptime:20

-->Ringin/OK
m=audio 10000 RTP/AVP 4 --- g723
a=ptime:30
```

5) INVITEs sent by the Vega will specify the ptime as that configured in the `media.packet.xxxx.y.packet_time` configuration parameter. In case where there are multiple codecs with different packet times being specified, the packet time of the first codec will be used.

For example, assuming

g723 configured to use 30ms packet time  
G.711 u-law configured to use 20ms packet time

```
-->Invite:
m=audio 10000 RTP/AVP 0 4 --- G.711 u-law or g723
a=ptime:20

<--Ringin
m=audio 10000 RTP/AVP 0 --- G.711 u-law
a=ptime:20
```

Or:

```
-->Invite:
m=audio 10000 RTP/AVP 4 0 --- g723 or G.711 u-law
a=ptime:30

<--Ringin
m=audio 10000 RTP/AVP 4 --- g723
a=ptime:30
```

6) If a Vega gets a ptime in the "SDP answer", the Vega will try to use it if it can. If it cannot, it will try to hangup the call and then add a message to the log:

For example:

```
-->Invite:
m=audio 10000 RTP/AVP 4 --- g723
a=ptime:20

<--Ringing
m=audio 10000 RTP/AVP 4 --- g723
a=ptime:300

-->Cancel
```

There will also be a log message:

```
LOG: 14/03/2003 09:56:43.660 SIP (I)Rd3C00 unsupported/unobtainable
packet time (300 ms)
call ref=[f100001f]
```

If ptime\_mode=mptime then the Vega will offer a list of ptimes, one for each codec, e.g. the sdp will look like:

```
m=audio 10002 RTP/AVP 0 8 4 18 96
c=IN IP4 136.170.209.134
a=rtpmap:0 PCMU/8000
a=rtpmap:8 PCMA/8000
a=rtpmap:4 G723/8000
a=rtpmap:18 G729/8000
a=rtpmap:96 telephone-event/8000
a=fmtp:96 0-15,16
a=mptime:30 30 30 20 -
a=sendrecv
```

In the above example, the packet time is 30ms G.711u-law, for 30ms for G.711a-law, 30ms for g723.1 and 20ms for 729. The packet times used correspond to the media.packet.xxx.y.packet\_time configuration parameters where xxx is the codec and y is the codec profile; NOTE: a dash is used for the telephone event packet time because the packet time used for telephone events corresponds to the packet time of the selected codec.

If ptime\_mode=x\_mptime then the Vega will offer a list of ptimes, one for each codec, just as for ptime\_mode=mptime; in this mode however, the key word is X-mptime: i.e.:

```
a=X-mptime:30 30 30 20 -
```

If `ptime_mode=ptime30` then the Vega will offer a 30ms value, unless all codecs are G.711, when it will use a 20ms, e.g. for G.711 codecs:

```
m=audio 10002 RTP/AVP 0 8
c=IN IP4 136.170.209.134
a=rtpmap:0 PCMU/8000
a=rtpmap:8 PCMA/8000
a=ptime:20
a=sendrecv
```

e.g. for codecs which include non G.711 codecs:

```
m=audio 10002 RTP/AVP 0 8 4 18
c=IN IP4 136.170.209.134
a=rtpmap:0 PCMU/8000
a=rtpmap:8 PCMA/8000
a=rtpmap:4 G723/8000
a=rtpmap:18 G729/8000
a=ptime:30
a=sendrecv
```

If `ptime_mode=ptime60` then the Vega will offer a 60ms value if all offered codecs are capable of supporting 60ms. If all codecs are G.711, then a value of 20ms will be used, and if not all codecs are G.711, but 60ms is not supported by all codecs then 30ms will be used.

e.g. for G.711 codecs only:

```
m=audio 10002 RTP/AVP 0 8
c=IN IP4 136.170.209.134
a=rtpmap:0 PCMU/8000
a=rtpmap:8 PCMA/8000
a=ptime:20
a=sendrecv
```

e.g. for all codecs (G.711 does not support 60ms):

```
m=audio 10002 RTP/AVP 0 8 4 18
c=IN IP4 136.170.209.134
a=rtpmap:0 PCMU/8000
a=rtpmap:8 PCMA/8000
a=rtpmap:4 G723/8000
a=rtpmap:18 G729/8000
a=ptime:30
a=sendrecv
```

e.g. for G.723.1 and G.729 codecs (both which support 60ms packets):

```
m=audio 10002 RTP/AVP 4 18
c=IN IP4 136.170.209.134
a=rtpmap:4 G723/8000
a=rtpmap:18 G729/8000
a=ptime:60
a=sendrecv
```



### 15.4.3.2 Maxptime attribute in SDP

In SIP SDPs a codec Maximum Packet Time (maxptime) may be specified. Control over whether or not the Vega will try to include a maxptime request in sdp depends on the setting of:

```
[_advanced.sip.sdp]
maxptime_enable           ; 0=do not include maxptime,
                          ; 1=try to include a maxptime
```

For example, if G.711 A law and u law are offered, with a preferred time of 20ms and each has a max time (dsp.xxx.packet\_time\_max) of 30, then the sdp will be as follows:

```
m=audio 10002 RTP/AVP 0 8
c=IN IP4 136.170.209.134
a=rtpmap:0 PCMU/8000
a=rtpmap:8 PCMA/8000
a=ptime:20
a=maxptime:30
```

An a=maxptime attribute will only be included in an sdp if it does not contradict other attributes, and if the a=maxptime is valid for all offered codecs.

So, for example if the codecs offered are G.711Alaw and G.729, the maxptime value will be the smaller of dsp.g711Alaw64k.packet\_time\_max and dsp.g729.packet\_time\_max. However, a=maxptime will only be put in to the sdp if it is consistent with a=ptime, a=X-ptime or a=ptime, i.e it does not specify a time smaller than these "preferred" times.

If the codecs offered are G.711Alaw and G.723.1, and dsp.g711Alaw64k.packet\_time\_max=20 then an a=maxptime will not be included in the sdp as a maxptime of 20ms is not valid for G.723.1 (the minimum packet size for G.723.1 is 30ms).

### 15.4.3.3 Direction attribute in SDP

In SIP SDPs a media direction attribute may be sent / received. The direction attribute takes one of the following 4 forms:

```
a=sendrecv
a=sendonly
a=recvonly
a=inactive
```

The way the Vega handles the sending / receiving of this attribute is controlled by:

```
[_advanced.sip.sdp]
direction_attribute       ; 0=do not include/handle direction attribute
                          ; 1=include and handle direction attribute
```

If disabled, the Vega will not include the direction attribute in sdp that it generates; it will also ignore direction attribute requests that it receives.

If enabled, for calls where the Vega is going to send the first sdp (this Vega is going to make the offer, the other device is going to answer) the Vega will always include a=sendrecv.

For calls where the Vega is going to respond to an incoming sdp (the other device is going to make the offer, and this Vega is going to answer) the response the Vega will make is as per the following table:

Received sdp	Vega's sdp response	Notes
A=sendrecv	a=sendrecv	
A=sendonly	a=recvonly	Vega mutes media transmission
A=recvonly	a=sendonly	Vega mutes media reception
A=inactive	a=inactive	Vega mutes media Tx and Rx
No direction attribute	a=sendrecv	

#### 15.4.4 Registration – Vega 400, Vega BRI, Vega FXS, Vega FXO

Whether the Vega registers or not is controlled on a per unit basis by:

```
[sip]
    reg_enable=1      ;0=do not register, 1 = register
```

The domain, hostname or IP address of the registrar is set using:

```
[sip.profile.x]
    reg_domain=<domain, hostname or IP address>
```

The lifetime, *s* seconds, of all registrations for the unit is configured using:

```
[sip.profile.x]
    reg_expiry=s
```

Registration requests are sent to the IP address and port number specified in the following parameters:

```
[sip.profile.x.registrar.y]
    reg_proxy
    reg_remote_rx_port
```

If `sip.reg_enable=1`, then:

```
[sip]
    reg_on_startup=0 or 1
```

controls whether the Vega will automatically register on start-up. If `sip.reg_on_startup=0` then registrations will only occur when the first call is made from that port. If `sip.reg_on_startup=1` then registrations will occur for all enabled registration users on system power-up or re-boot.

A number of SIP Registration Users may be set up. The parameters to do this are:

```
[sip.reg.user.1]
    auth_user_index=1
    dn=100
    enable=1
    username=RegUser1
```

```
[sip.reg.user.2]
    ... etc
```

```
... etc
```

The Vega will register with each `sip.reg.user.x` that is enabled. `username` forms the central part of the username used for registration. `Dn` provides the telephone number part of the contact information, i.e. `dn@ip_address_of_vega`.

If the registration server is going to request authentication, then configure `auth_user_index` to point to the `sip.auth.user.n` info that should be used to respond to the authentication challenge.

NOTE

1. Vega gateways support the ability to use more than 1 registrar for redundancy and for load balancing purposes. Either multiple alternative Registrars can be defined through use of a list of Registrars, or multiple alternative Registrars can be defined through use of DNS SRV records on a single DNS SRV name. This operates exactly the same way that Multiple SIP proxies do – see section 15.4.2.1 “Multiple SIP Proxy Support” for details.
2. Vega gateways can register with multiple proxies simultaneously (one per sip profile). For more details see [Using\\_multiple\\_registrations\\_on\\_R8\\_x\\_01](#) on the technical documents page of [www.VegaAssist.com](http://www.VegaAssist.com)

*For more details on the structure of registration and other SIP messages, see IN\_10- Introduction to Vega SIP messaging.*

*Also see the ‘SIP REGISTRATON and SIP INVITE configuration’ utility on the [www.VegaAssist.com](http://www.VegaAssist.com) (Documentation > Step by step configuration).*

### 15.4.5 Authentication – Vega 400, Vega BRI, Vega FXS, Vega FXO

Vega gateways may be configured to respond appropriately to authentication challenges (e.g. to REGISTRATION, INVITE, ACK and BYE messages).

Vega gateways support the ability to define one or more authentication username and password combinations to respond to the authentication challenges. The parameters used are:

```
[sip.auth.user.1]
  enable=1
  username=authuser1
  password=pass1
  srce=IF:01

[sip.auth.user.2]
  enable=1
  username=authuser2
  password=pass2
  srce=IF:02,TEL:0123.*
```

The username used in the response to the authentication challenge is sip.auth.user.n.username

The username / password combination defined for a user is valid for calls whose telephony details match the *srce* specification. *srce* can contain the IF: and TEL: tokens to match against the call details. For telephony to LAN calls, *srce* is matched against the incoming call details, for LAN to telephony, *srce* is matched against the call details used for making the telephony call (i.e. the destination call details).

NOTE
------

1. *srce* may only use Dial Plan *srce* wildcards, e.g. .\*?[xyz] – it may not use destination wildcards like <1> as this will not be defined.
2. If the case where different users' *srce* expressions overlap, the Vega will just use the username / password in the first found user that matches.

### 15.4.6 Incoming INVITES

```
[sip]
  accept_non_proxy_invites=0 or 1
```

controls whether the Vega will accept INVITES from sources other than the configured default\_proxy (and backup proxies).

### 15.4.7 Local and Remote Rx Ports

The default UDP port number used for SIP signalling is 5060. Sometimes, however, use of a different port number may be desired.

```
[sip]
  local_rx_port=1 to 65535 ;default=5060
```

sets the UDP port on which the gateway expects to receive SIP messages. If the value is non-5060 then the gateway will listen on both ports 5060 and the one specified by `sip.local_rx_port`.

```
[sip]
  remote_rx_port=1 to 65535 ;default=5060
```

sets the UDP port to which the gateway should send SIP messages.

#### 15.4.8 PRACK Support

Allows configuration of the gateway to send PRACKs (Provisional ACKnowledgements). By default this is "off" but you can set it to "supported" or "required":

```
[sip]
  prack=supported
```

Permitted values:

- `off` – PRACK not supported at all
- `supported` – the gateway will use PRACK if the remote proxy or gateway requires it
- `required` – the gateway will insist that the remote proxy or gateway uses PRACK otherwise the connection will not proceed

#### 15.4.9 REFER/REPLACES

All Vega gateways will respond to the REFER / REPLACES method for transferring calls, but only FXS gateways can initiate call transfers (initiated using hookflash – if supplementary services is enabled)<sup>9</sup>.

On receiving a REFER, the Vega will send an INVITE (with the replaces header) to the destination specified in the REFER. If the INVITE resulting from the REFER should be sent via the SIP proxy, set:

```
[_advanced.sip]
  refer_invite_to_proxy=1
```

---

<sup>9</sup> See the 'FXS Call Transfer' document for more details on configuring FXS ports to initiate call transfers.

### 15.4.10 RPID – Remote Party ID header

SIP Vegas support the generation and reception of the SIP RPID (Remote Party ID) header in INVITE messages.

RPID headers provide the SIP recipient with details of the calling party and the original called number or the (last) redirecting number.

To enable the generation and reception of RPID headers, set:

```
[_advanced.sip.privacy]
    standard=rpid ; default=rfc3323
```

#### 15.4.10.1 Mapping ISDN SETUP Information Elements to SIP RPID header parameters

Four cases are illustrated to demonstrate the methodology used in translating the paramterters

##### Case 1 – Calling number presentation allowed

<i>ISDN SETUP</i> <sup>10</sup>	<i>SIP INVITE</i>
Called party number IE>number digits	Request-URI & user part of To:
Calling party number IE>number digits	User part of From:
Calling party number IE>presentation (allowed)	not explicitly forwarded
Display IE	Name part of From:

##### Case 2 – Calling number presentation allowed with original called number or redirection IE

<i>ISDN SETUP</i>	<i>SIP INVITE</i>
Called party number IE>number digits	Request-URI & user part of To:
Calling party number IE>number digits	User part of From:
Calling party number IE>presentation (allowed)	not explicitly forwarded
Display IE	Name part of From:
Original called number / redirection IE	RPID>party=redirect
Original called number / redirection IE>number digits	RPID>user=
Original called number / redirection IE>screening indicator	RPID>screen=
Original called number / redirection IE>Presentation	RPID>privacy=

RPID header format:

```
Remote-Party-ID: "rpid_disp_name" <sip:rpid_CgPN@domain;user=phone>;rpid_options
```

e.g.:

```
Remote-Party-ID: "John Smith" <sip: 01344123456@vegastream.com;user=phone>;screen=yes;party=calling
```

---

<sup>10</sup> IE stands for Information Element; a message element in ISDN signalling

**Case 3 – Calling number presentation restricted**

<b>ISDN SETUP</b>	<b>SIP INVITE</b>
Called party number IE>number digits	Request-URI & user part of To:
	User part of From: = “restricted user”
	Name part of From: = “restricted name”
Calling party number IE	RPID>party=calling
Calling party number IE>number digits	RPID>user=
Calling party number IE>Screening indicator	RPID>screen=
Calling party number IE>presentation (restricted)	RPID>privacy=full
Display IE	RPID>display-name

**Case 4 – Calling number presentation restricted with original called number or redirection IE**

<b>ISDN SETUP</b>	<b>SIP INVITE</b>
Called party number IE>number digits	Request-URI & user part of To:
	User part of From: = “restricted user”
	Name part of From: = “restricted name”
Calling party number IE	RPID>party=calling
Calling party number IE>number digits	RPID>user=
Calling party number IE>screening indicator	RPID>screen=
Calling party number IE>presentation (restricted)	RPID>privacy=full
Display IE	RPID>display-name
Original called number / redirection IE	RPID>party=redirect
Original called number / redirection IE>number digits	RPID>user=
Original called number / redirection IE>screening indicator	RPID>screen=
Original called number / redirection IE>presentation	RPID>privacy=

**15.4.10.2 Mapping SIP RPID header parameters to ISDN SETUP Information Elements**

Three cases are illustrated to demonstrate the methodology used in translating the parameters

**Case 1 – No RPID headers**

<b>SIP INVITE</b>	<b>ISDN SETUP</b>
Request-URI	Called party number IE>number digits
User part of From:	Calling party number IE>number digits
Name part of From:	Display IE

**Case 2 – with calling RPID header**

<b>SIP INVITE</b>	<b>ISDN SETUP</b>
Request-URI	Called party number IE >number digits
RPID>party=calling	Calling party number IE
RPID>user=	Calling party number IE>number digits
RPID>screen=	Calling party number IE>screening indicator
RPID>privacy=	Calling party number IE>presentation
RPID>display-name	Display IE

**Case 3 – with calling and redirect RPID headers**

<b>SIP INVITE</b>	<b>ISDN SETUP</b>
Request-URI	Called party number IE>number digits
RPID>party=calling	Calling party number IE
RPID>user=	Calling party number IE>number digits
RPID>screen=	Calling party number IE>screening indicator
RPID>privacy=	Calling party number IE>presentation
RPID>display-name	Display IE
RPID>party=redirect	Original called number / redirection IE
RPID>user=	Original called number / redirection IE>number digits
RPID>screen=	Original called number / redirection IE>screening indicator
RPID>privacy=	Original called number / redirection IE>presentation

**15.4.10.3 ISDN screening indicator to SIP screen Mappings**

<b>Screening indicator</b>	<b>RPID&gt;screen</b>
User provided, not screened	screen=no
User provided, verified and passed	screen=yes
User provided, verified and failed	screen=no
Network provided	screen=no

**15.4.10.4 SIP screen to ISDN screening indicator Mappings**

<b>RPID&gt;screen</b>	<b>Screening indicator</b>
Screen=no	User provided, not screened
Screen=yes	User provided, verified and passed

**15.4.10.5 Mappings between ISDN presentation indicator and SIP privacy**

<b>Presentation indicator</b>	<b>RPID&gt;privacy</b>
Allowed	privacy=off
Restricted	privacy=on

**15.4.11 RFC 3323 Privacy header and RFC 3325 extensions**

SIP Vega gateways support the generation and reception of the Privacy header in INVITE and REGISTER messages, as defined in RFC 3323, and also the P-Asserted-Identity and P-Preferred-Identity headers defined in RFC3325.

The Privacy: header provides details about how the details relating to the calling party should be handled.

To enable the generation and reception of the Privacy: header, set:

```
[_advanced.sip.privacy]
    standard=rfc3323                ; default=rfc3323
```



The Privacy: header can include one or more of the following values:

- header<sup>11</sup>
- session<sup>12</sup>
- user
- none
- id<sup>13</sup>

optionally followed by

- ;critical

Note that if multiple types of privacy are required, all privacy types MUST be included in the Privacy header field value.

*header: Request that privacy services modify headers that cannot be set arbitrarily by the user (Contact/Via).* The user requests that those headers which might reveal information about the user be obscured. Also, that no unnecessary headers should be added by the service that might reveal personal information about the originator of the request.

*session: Request that privacy services provide privacy for session media.* The user requests that a privacy service provide anonymisation for the session(s) initiated by this message. This will mask the IP address from which the session traffic would ordinarily appear to originate. When session privacy is requested, user agents MUST NOT encrypt SDP bodies in messages.

*user: Request that privacy services provide a user-level privacy function.* This privacy level is usually set only by intermediaries, in order to communicate that user level privacy functions must be provided by the network, presumably because the user agent is unable to provide them. User agents MAY however set this privacy level for REGISTER requests, but SHOULD NOT set 'user' level privacy for other requests. Any non-essential information headers are to be removed and changes to From: and Call-ID: headers to make them anonymous is to be performed.

*none: Privacy services must not perform any privacy function.* The user requests that a privacy service apply no privacy functions to this message, regardless of any pre-provisioned profile for the user or default behavior of the service. User agents can specify this option when they are forced to route a message through a privacy service which will, if no Privacy header is present, apply some privacy functions which the user does not desire for this message.

*id: Privacy requested for Third-Party Asserted Identity.* The user requests that the Network Asserted Identity to be kept private with respect to SIP entities outside the Trust Domain with which the user is authenticated.

*critical: Privacy service must perform the specified services or fail the request.* The user asserts that the privacy services requested for this message are critical, and that therefore, if these privacy services cannot be provided by the network, this request should be rejected.

The extensions of RFC3325 add P-Asserted-Identity and P-Preferred\_Identity.

**P-Asserted-Identity:** This is used between Trusted SIP entities; it carries the identity of the user sending the SIP message as verified by authentication. There may be one or two P-Asserted-Identity values. If there is one value, it MUST be a sip, sips, or tel URI. If there are

---

<sup>11</sup> Not currently supported by the Vega

<sup>12</sup> Not currently supported by the Vega

<sup>13</sup> id is an extension to RFC3323 defined in RFC 3325

two values, one value MUST be a sip or sips URI and the other MUST be a tel URI.  
(Note: proxies can (and will) add and remove this header field.)

**P-Preferred-Identity:** This is used between a user agent and a Trusted Proxy; it carries the identity that the user sending the SIP message wishes to be used as the P-Asserted-Header that the Trusted Proxy will insert. There may be one or two P-Preferred-Identity values. If there is one value, it MUST be a sip, sips, or tel URI. If there are two values, one value MUST be a sip or sips URI and the other MUST be a tel URI.  
(Note: proxies can (and will) add and remove this header field.)

#### 15.4.11.1 ISDN to SIP

**ISDN Presentation Indicator to SIP Privacy Header mapping:**

<i>ISDN Presentation Indicator</i>	<i>SIP Privacy Header Content</i>
Allowed	Privacy: none
Restricted	Privacy: id
Number not available	Privacy: id

**ISDN screening indicator to SIP P-Asserted-Identity / P-Preferred-Identity mapping**

<i>ISDN Screening Indicator</i>	<i>SIP Header</i>
Not screened	P-Preferred-Identity
Passed	P-Asserted-Identity
Failed	P-Preferred-Identity
Network	P-Asserted-Identity

e.g. Preferred Identity:  
 Privacy: id  
 P-Preferred-Identity: "Steve Hight" <sip:4917@sip.vegastream.com>

e.g. Asserted Identity:  
 P-Asserted-Identity: "Steve Hight" <sip:4917@sip.vegastream.com>  
 P-Asserted-Identity: tel:+441344784917  
 Privacy: id

#### 15.4.11.2 SIP to ISDN

**SIP Privacy Header to ISDN Presentation Indicator mapping:**

<i>SIP Privacy Header Content</i>	<i>ISDN Presentation Indicator</i>
Privacy: user	Restricted
Privacy: none	Allowed
Privacy: id	Restricted

**SIP P-Asserted-Identity / P-Preferred-Identity to ISDN screening indicator mapping**

<i>SIP Header</i>	<i>ISDN Screening Indicator</i>
P-Asserted-Identity	Network
P-Preferred-Identity	Not screened

### 15.4.12 Session Timers

In order that SIP gateways can ensure calls are cleared down even if they never receive a BYE message, session timers can be enabled. These are defined with the following parameters:

```
[sip]
  sess_timer_index=1

[sip.sess_timer.n]
  enable=0
  interval=1800
  min_interval=300
  refresher_pref=remote
```

`sess_timer_index` chooses the appropriate `[sip.sess_timer.n]` (n=1 to 3) set of parameters to use. If `enable=1` the Vega will act upon / generate session timer fields.

If the Vega initiates the SIP call it sends out an INVITE with the session timer value set to `interval`, and the refresher parameter set to UAS or UAC depending on whether `refresher_pref` is set to remote or local (respectively). If `refresher_pref` is set to local then the Vega will initiate the session timer checks.

If a 422 response is received, the Vega will accept the higher requested session timer value.

If the Vega receives a call with the session timer value set, provided that the time is greater than `min_interval` then the Vega will accept the session timer value. It will accept the requested UAC / UAS setting of the refresher parameter in the SIP message (initiating session timer checks if the setting is UAS).

If the session time value received is smaller than `min_interval` then the Vega will send out a 422 with the requested time set to `min_interval`.

If the Vega is generating the session timer checks, after about half the negotiated session timer timeout value (the session timer value both ends agree), the Vega will send out REINVITE<sup>14</sup>. If it receives a '200 OK' it re-starts the timer, if it does not receive the '200 OK' after half the time to the timeout it sends another REINVITE. If no '200 OK' response is received by the time the negotiated session timer timeout expires the call is cleared (a BYE is sent).

If the Vega is receiving the session timer checks, it too will count down the negotiated (agreed) session timer timeout. If a REINVITE is received it will re-start the counter. If the countdown expires then it will clear the call and send a BYE.

*For more details on the Session Timers see RFC 4028.*

---

<sup>14</sup> Providing that there is enough time to do send out the REINVITE. To ensure the REINVITE is sent, make sure that `min_interval`  $\geq$  480ms.

### 15.4.13 Phone Context Headers

Phone contexts can be added to the To and From headers in SIP messaging for Vega initiated calls using the table below, found on the SIP page of the web browser.

Phone Contexts					
Local Phone-Context					
Enabled	<input checked="" type="checkbox"/>				
Del?	ID	Enable	Name	TON	NPI
<input type="checkbox"/>	1	<input type="checkbox"/>	local_phone.1.com	any	any
<input type="button" value="Add"/> <input type="button" value="Delete"/> <input type="button" value="Submit"/>					
Remote Phone-Context					
Enabled	<input checked="" type="checkbox"/>				
Del?	ID	Enable	Name	TON	NPI
<input type="checkbox"/>	1	<input checked="" type="checkbox"/>	micrososft-ocs.com	any	any
<input type="button" value="Add"/> <input type="button" value="Delete"/> <input type="button" value="Submit"/>					

**Local Phone-Contexts** are used to populate the From header for ISDN to SIP calls based on the values of TON (Type of Number) and NPI (Numbering Plan Information) in a received ISDN SETUP message. They are also used to set the values for TON and NPI in the called party number IE in the outgoing ISDN SETUP when a matching phone context is received in a SIP INVITE.

**Remote Phone-Contexts** are used to populate the To header for ISDN to SIP calls based on the incoming values of TON (Type of Number) and NPI (Numbering Plan Information) in an received ISDN SETUP message. They are also used to set the values for TON (Type of Number) and NPI (Numbering Plan Information) in the calling party number IE in the outgoing ISDN SETUP when a matching phone context is received in a SIP INVITE

The following parameters have been added to configuration database for this feature (displayed here with default values):

```
admin >show phone_context
[phone_context.local.1]
  enable=1
[phone_context.local.1.pc.1]
  NPI=any
  TON=any
  enable=0
  name=local_phone.1.com
[phone_context.remote.1]
  enable=1
[phone_context.remote.1.pc.1]
  NPI=any
  TON=any
  enable=0
  name= remote_phone.1.com
```

## Example SIP INVITE with phone-contexts setup:

```

SIP m:3809212 47750 00034--- UA TX --> To      TCP(162):172.19.1.55:5060
  INVITE sip:1234;phone-context=microsoft-ocs.com@default-reg-domain.com:5060;user=phone
SIP/2.0
  Via: SIP/2.0/TCP 172.19.1.67:5060;branch=z9hG4bK-vega1-000A-0001-0004-CB9A50C9
  From: "0" <sip:0;phone-context=microsoftremote-ocs.com@default-reg-domain.com>;tag=007D-
0006-DBDE6A28
  To: <sip:1234;phone-context=microsoft-ocs.com@default-reg-domain.com>
  Max-Forwards: 70
  Call-ID: 0078-0004-63929283-0@91AD727D0597C801D
  CSeq: 1523683 INVITE
  Contact: <sip:0;phone-context=microsoftremote-ocs.com@172.19.1.67:5060;transport=tcp>
  Supported: replaces, privacy
  Allow: INVITE,ACK,BYE,CANCEL,INFO,NOTIFY,OPTIONS,REFER,UPDATE
  Accept-Language: en
  Content-Type: application/sdp
  Privacy: none
  P-Preferred-Identity: "0" <sip:0;phone-context=microsoftremote-ocs.com@default-reg-
domain.com>
  User-Agent: VEGA400/10.02.08.2xS028
  Content-Length: 294

v=0
o=Vega 134 134 IN IP4 172.19.1.67
s=Sip Call
c=IN IP4 172.19.1.67
t=0 0
m=audio 10008 RTP/AVP 18 0 8 4 101
a=rtpmap:18 G729/8000
a=rtpmap:0 PCMU/8000
a=rtpmap:8 PCMA/8000
a=rtpmap:4 G723/8000
a=rtpmap:101 telephone-event/8000
a=fmtp:101 0-15,16
a=fmtp:18 annexb=no
a=sendrecv

```

#### 15.4.14 User Defined String in SIP To / From Headers

User defined strings can be added to the SIP To and From and To headers sent by the Vega. A typical use of this parameter is to add the “user=phone” parameter to SIP INVITEs sent by the Vega.

Parameter:

`_advanced.sip.from_header_uri_params`

Possible values:

NULL - Default - Don't include any string  
Any string between 1 and 39 characters in length

Parameter:

`_advanced.sip.to_header_uri_params`

Possible values:

NULL - Default - Don't include any string  
Any string between 1 and 39 characters in length

For example, if `from_header_uri_params="user=phone"`, a SIP INVITE would be similar to this:

```
SIP m:0626532 626532 00001--- UA TX --> To      TCP(72):172.19.1.55:5060
  INVITE sip:1234@default-reg-domain.com:5060;user=phone SIP/2.0
  Via: SIP/2.0/TCP 172.19.1.67:5060;branch=z9hG4bK-vegal-000A-0001-0000-8C21B472
  From: "0" <sip:0@default-reg-domain.com;user=phone>;tag=007E-0000-CB58C2DC
  To: <sip:1234@default-reg-domain.com;user=phone>
  Max-Forwards: 70
  Call-ID: 0078-0000-61F25547-0@91AD727D0597C801D
  CSeq: 250611 INVITE
  Contact: <sip:0@172.19.1.67:5060;transport=tcp>
  Supported: replaces, privacy
  Allow: INVITE,ACK,BYE,CANCEL,INFO,NOTIFY,OPTIONS,REFER,UPDATE
  Accept-Language: en
  Content-Type: application/sdp
  Content-Length: 294
```

## 15.5 RFC2833

RFC2833 is a standard for transmitting and receiving DTMF signals and hookflash as part of the real-time media stream.

For DTMF/hookflash to be sent as RFC2833 messages, firstly ensure that "Out Of Band DTMF" is configured True against the appropriate codec.

### 15.5.1 RFC2833 Configuration

```
[sip]
    dtmf_transport=rfc2833 ; use rfc2833 to send out-of-band DTMF (to use info
                           messages, set dtmf_transport=info; to transit both
                           RFC2833 and info messages, and to act upon received
                           RFC2833 messages, set dtmf_transport=rfc2833_txinfo)
    rfc2833_payload=96    ; Configures the payload field in RTP messages for
                           RFC2833 data. RFC2833 data is sent in its own
                           UDP/IP packets (it is not combined with the audio).

[_advanced.rfc2833]
    one_shot=0/1          ; In rfc2833 messages DTMF tone duration may or may
                           not be retained: 0 = true duration played, 1 = single fixed
                           length DTMF tone pulses played (on-time is defined by
                           _advanced.dsp.dtmf_cadence_on_time, off time defined
                           by _advanced.dsp.dtmf_cadence_off_time)
    audio_with_DTMF=0/1  ; 0 = no audio packets are sent when RFC2833 tone
                           packets are sent; 1 = send both audio packets and
                           RFC2833 tone packets when tone present
    tx_volume=0 to 127   ; Power level of tone reported in Tx RFC2833 packets = -
                           n dBm0 (e.g. 10 => -10dBm0). RFC2833 says tones
                           with a power 0 to -36dBm0 must be accepted, and
                           below -55dBm0 must be rejected.
```

## 15.6 Executive Interrupt

Vega gateways support Resource-Priority Headers for Preemption Events, as defined by RFC 4411 & RFC 4412.

This is a method by which calls from higher priority callers, rather than receiving a busy response when making a call to a phone already engaged on a phone call, will 'bump' the other party in the conversation and will be connected directly to the called party. This feature is sometimes known as 'Executive Intrusion', 'Boss / Secretary' working, Call Barge, MLPP or Multi-Level Precedence and Preemption.

If enabled, INVITES are sent out with Resource-Priority header values; also received INVITES containing a Resource-Priority header will not necessarily be rejected with busy, but will 'bump' the existing call if its Resource-Priority is higher than the Resource-Priority of the call in progress.

Call with precedence  $Y \leq$  precedence  $X$

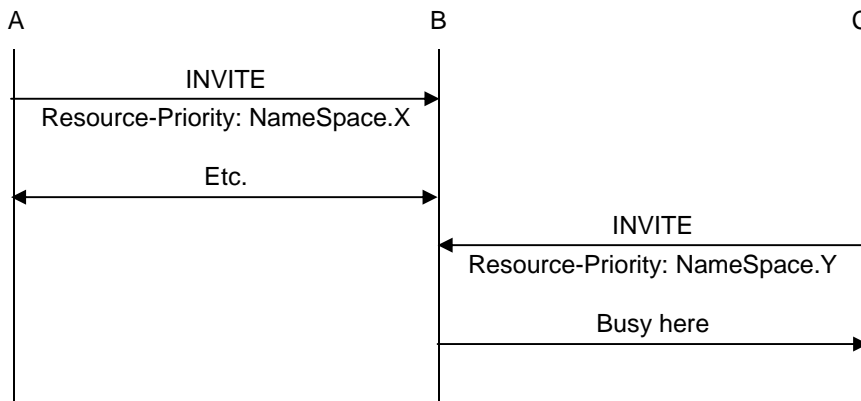

Call with precedence  $Y >$  precedence  $X$

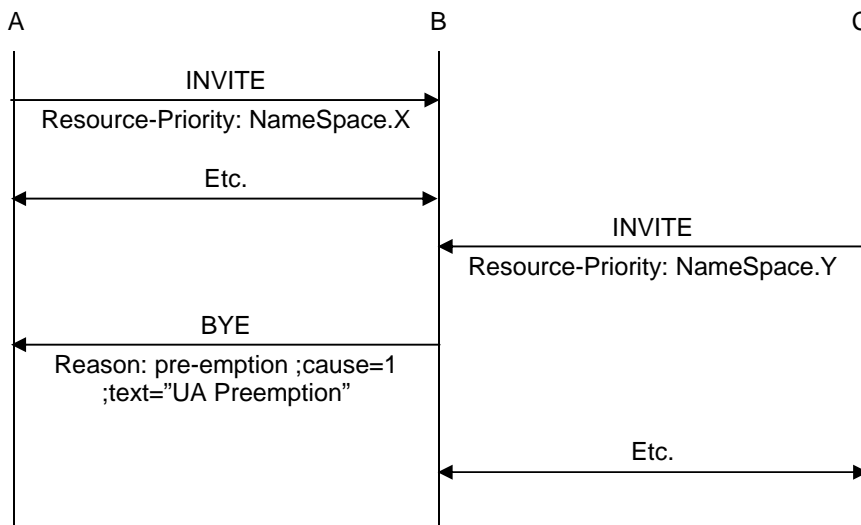

If a call gets 'bumped' the BYE for that call will contain a Reason header containing "cause=1 ;text="UA Preemption".



### 15.6.1 Configuring NameSpace for Resource-Priority Headers

A NameSpace defines a set of named priority values used in Resource-Priority headers. It is a priority ordered list of priority names. Three standard NameSpace definitions are pre-configured in the Vega: dsn, drsn and q735. Additional user defined NameSpace definitions may be set up.

At any time the Vega only uses a single NameSpace definition to generate Resource-Priorities in outgoing SIP calls and to act upon received Resource-Priorities in incoming SIP calls.

The NameSpace definition to use is configured in the Selected Namespace option.

If a call is received for a NameSpace other than that configured, the Vega will treat the call as though it were a standard call with no Resource-Priority header.

**SIP > Namespaces**

Selected Namespace:

Namespace	Name	Priorities	Chg?
1	dsn	routine,priority,immediate,flash,flash-override	fixed
2	drsn	routine,priority,immediate,flash,flash-override,flash-override-override	fixed
3	q735	4,3,2,1,0	fixed
4	user	4,3,2,1,0	<a href="#">Modify</a>

Namespace definitions are priority ordered lists of names or IDs of priorities, listed in increasing priority order.

e.g. dsn: lowest priority = routine  
highest priority = flash-override.

Selecting modify in the user defined list allows the NameSpace Name and Priority values (IDs) to be configured.

**SIP > Namespaces > Namespace 4**

**Namespace 4**

Name:

Priorities:

## 15.6.2 Resource-Priority for SIP calls initiated by Vega gateways

The Resource-Priority to use for outbound SIP calls is defined in the SIP authentication configuration section.

**SIP > Authentication**

SIP Authentication Users								
Del?	User	Enable	SIP Profile	Username	Password	Subscriber	Resource Priority	Chg?
<input type="checkbox"/>	1	1	1 - profile1	01	vega	IF:0101	routine	<a href="#">Modify</a>
<input type="checkbox"/>	2	1	1 - profile1	02	vega	IF:0102	routine	<a href="#">Modify</a>
<input type="checkbox"/>	3	1	1 - profile1	03	vega	IF:0103	flash	<a href="#">Modify</a>
<input type="checkbox"/>	4	0	1 - profile1	04	user04	IF:0104	routine	<a href="#">Modify</a>
<input type="checkbox"/>	5	1	1 - profile1	authuser1	pass1	IF:00	routine	<a href="#">Modify</a>
<input type="checkbox"/>	6	1	1 - profile1	authuser1	pass1	IF:00	routine	<a href="#">Modify</a>
<input type="checkbox"/>	7	1	1 - profile1	authuser1	pass1	IF:00	routine	<a href="#">Modify</a>

[Add](#) [Delete](#)

A single Resource-Priority may be configured for each SIP Authentication User. (The subscriber field defines which telephony port(s) the SIP Authentication User represents.)

**SIP > Authentication > User**

**Modify SIP Authentication User**

**SIP Authentication User 1**

Enable	<input checked="" type="checkbox"/>
SIP Profile	1
Username	01
Password	vega
Subscriber	IF:0101
Resource Priority	routine

- routine
- priority
- immediate
- flash
- flash-override

The resource priority is configured through the selection of an entry in a pull down box. The values contained in the pull down box are the values defined in the NameSpace configuration (see section 15.6.1 "Configuring NameSpace for").

The value selected will be the value sent out as the Resource-Priority with every SIP call made by that user.

**NOTE**

Ensure that the SIP Authentication User is enabled, otherwise Resource-Priority handling will not be activated.

## 15.7 SIP Music on Hold (MoH)

In default configuration, when a caller is put on hold they hear silence.

From Release 8.3 the Vega supports the playing of Music on Hold to the held party. Vega gateways support the `draft-ietf-sipping-service-examples-11` method of supplying music on hold.

This is easily configured through the web browser interface. On the SIP > SIP Music On Hold Configuration page:

**SIP Music On Hold Configuration**

Mode:

SIP Music Servers		
URI	IP/Hostname	Port
<input type="text" value="0404201@172.19.1.97"/>	<input type="text" value="172.19.1.97"/>	<input type="text" value="5060"/>

set up the SIP Music server

- the URI is used to construct the SIP message
- the IP / HostName and its IP port create the IP address to send the SIP messages to

Then select mode = `sipping_service_11` to enable the `draft-ietf-sipping-service-examples-11` method of supplying music on hold.

The `draft-ietf-sipping-service-examples-11` method operates as follows:

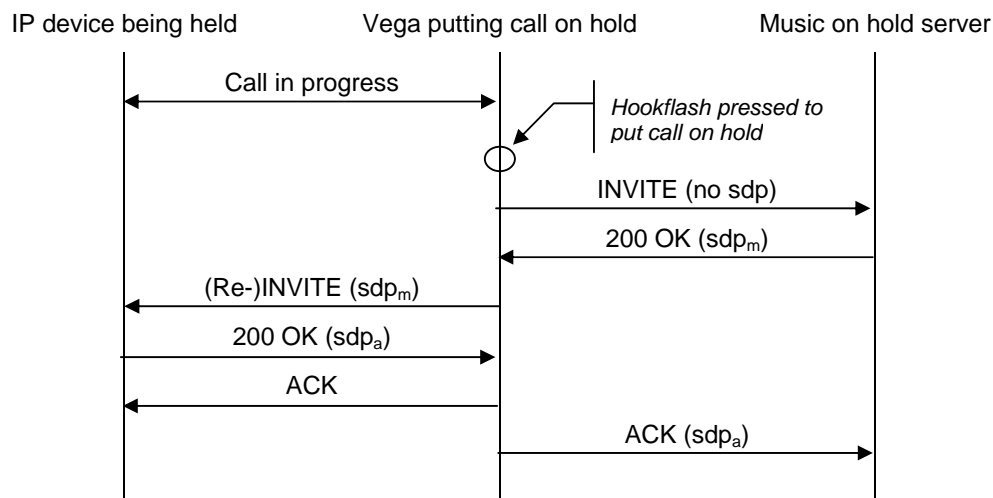

The Vega responds to 1xx provisional responses by opening media if an SDP body has been received.

## 15.8 Multiple SIP Signalling Ports

FXS gateways can optionally be configured to use a unique local SIP signalling port for each configured SIP registration user. For instance, on a Vega 5000 24 port, provided each FXS port has an associated registration user the Vega would use ports 5060 to 5083 for SIP signalling. This can be particularly useful when working with a SIP proxy or softswitch that doesn't expect multiple SIP UA's to be present behind a single IP address. i.e. Cisco Call Manager (CCM)

Parameter:

`_advanced.sip.cisco_cm_compatibility`

Possible Values:

- 0 - Default - Do not use multiple SIP ports
- 1 - Use a distinct SIP port for each registration user



**WARNING!**

If this feature is enabled the local signalling port for TLS must be set so that it's outside the range that will be used for multiple port signalling. The parameter that controls the TLS port is `sip.tls.local_rx_port`.

## 15.9 TDM Channel Information

TDM (ISDN / POTS) B channel and interface information can be advertised in SIP messages using 'P-Access-Network-Info' headers.

In the case where a call originates from the Vega the header is included in the original SIP request message (INVITE). In the case where the Vega terminates the call the header is included in the ringing indication message (typically 180 or 183) or if not present in the 200 OK (connect) message.

Parameter:

`_advanced.sip.access_network_info.enable`

Possible values:

- 0 - Default - Do not include the P-Access-Network-Info header
- 1 - Include the P-Access-Network-Info header

Sample SIP message header:

```
SIP m:0332867 18540 00124--- UA TX --> To      UDP(3):172.19.1.58:5060
INVITE sip: 123@default-reg-domain.com:5060 SIP/2.0
Via: SIP/2.0/UDP 172.19.1.81:5060;rport;branch=z9hG4bK-vega1-000A-0001-0012
From: "unknown" <sip: 17219158@default-reg-domain.com>;tag=007D-0015
To: <sip: 123@default-reg-domain.com>
Max-Forwards: 70
Call-ID: 0078-000E-66ACE409-00000000@D02C806FC093603C6
CSeq: 133147 INVITE
P-Access-Network-Info: X-VEGA-NET;x-if0401;x-port0000;x-chan0001
Contact: <sip: 17219158@172.19.1.81:5060>
Supported: replaces, privacy
Allow: INVITE,ACK,BYE,CANCEL,INFO,NOTIFY,OPTIONS,REFER,UPDATE
Accept-Language: en
Content-Type: application/sdp
Content-Length: 294
```

In the example message header above the incoming ISDN call was placed using interface 0401 on bearer channel 1.

## 15.10 SIP Status codes

### 15.10.1 1xx - SIP Provisional Responses Supported

The Vega responds to 1xx provisional responses by opening media if an SDP body has been received.

1xx responses generated by the Vega are:

- 100 Trying - The Vega received an INVITE request and is processing it.
- 180 Ringing - The destination of the call is ringing.
- 181 Call is being forwarded
- 183 Session Progress - The call has not yet been answered but media is available.

Other 18x messages, like 182 Queued are accepted.

### 15.10.2 2xx - SIP Success Codes Supported

The Vega supports both 200 and 202 messages:

- 200 OK
- 202 Accepted - The Vega has accepted a transfer request and will generate an INVITE to the transfer target.

### 15.10.3 3xx - SIP Redirection Codes Supported (Responded To)

The Vega responds to 3xx responses by trying to initiate another call if alternative "contacts" are provided, otherwise the call is terminated.

- 300 Multiple Choices
- 301 Moved Permanently
- 302 Moved Temporarily
- 305 Use Proxy
- 380 Alternative Service

**15.10.4 4xx - SIP Request Failure Codes Supported**

With the exception of "401 Unauthorised", "407 Proxy Authentication Required", "415 Unsupported Media Type" and "491 Request Pending", 4xx responses result in termination of the call.

4xx responses generated by the Vega are<sup>15</sup>:

400 Bad Request	- Missing Call-ID field; the Vega received a request with a "Call-ID" field that was missing or invalid.
400 Bad Request	- Missing To field; the Vega received a request with a "To" field that was missing or invalid.
400 Bad Request	- Missing From field; the Vega received a request with a "From" field that was missing or invalid.
401 Unauthorised (retry Register)	- The Vega attempts to resend the INVITE with the authentication response
[402 Payment Required]	
[403 Forbidden]	
404 Not Found	- The Vega could not find a route for the destination (sometimes caused by dial plan errors).
405 Method Not Allowed	- The Vega received a request that it knows about but does not allow. e.g. when a PRACK request is received when sip.PRACK=off
406 Not Acceptable	- The Vega received an INVITE with an illegal SDP.
407 Proxy Authentication Required	- The Vega tries to resend the INVITE with the authentication response
<sup>16</sup> [408 Request Timeout	- The server could not produce a response within a suitable amount of time, for example, if it could not determine the location of the user in time.]
409 Conflict	
410 Gone	
411 Length Required	
413 Request Entity Too Large	- the content length of a request must not exceed 1500 bytes.
414 Request-URI Too Long	- The request-URI must not exceed 100 characters
415 Unsupported Media Type	- The request received by the Vega has a message body which is in an unsupported format. (Note: not necessarily a media problem)

---

<sup>15</sup> Items in square brackets are not generated by the Vega, but will be handled by the Vega.

<sup>16</sup> 408 is not generated by the Vega, but it will accept and handle it

- 420 Bad Extension - The Vega did not understand the protocol extension specified in a "Proxy-Require" or "Require" header.
- 422 Session Interval Too Small - The Session Interval requested is lower than the min\_interval configured in the Vega
- 480 Temporarily Unavailable - The Vega received a cause 18 (no user responding) disconnection on its telephony interface.
- 481 Call Leg/Transaction Does Not Exist - The Vega received a request for which a matching call leg and/or transaction was not found.
- 482 Loop Detected
- 483 Too Many Hops
- 484 Address Incomplete
- 485 Ambiguous
- 486 Busy Here - The destination of the call is busy.
- 487 Request Terminated - An INVITE request has been cancelled.
- 488 Not Acceptable Here - An INVITE was received for which no media is supported. (i.e. expect Codec mismatch.) This will be accompanied with a "304 No matching media" warning.
- 491 Request Pending - If the Call ID does not relate to this Vega, a REINVITE is sent immediately. Otherwise, the Vega waits for the other party to send a REINVITE

#### 15.10.5 5xx - SIP Server Failure Codes Supported

The Vega responds to 5xx responses by terminating the call.

5xx responses generated by the Vega are:

- 500 Server Internal Error - No Call Legs Left; there are no more SIP resources available
- 500 Server Internal Error - Still Processing Old Invite; an INVITE was received while an earlier INVITE was still being processed.
- 500 Server Internal Error - Destination Out Of Order; the Vega received a cause 27 (destination out of order) on its telephony interface.
- 500 Server Internal Error - Temporary Failure; the Vega received a cause 41 (Temporary failure) on its telephony interface.
- 500 Server Internal Error - No Channel Available; the Vega received a cause 34 (no circuit/channel available) on its telephony interface.
- 500 Server Internal Error - Requested Channel Not Available; the Vega received a cause 44 (Requested circuit/channel not available) on its telephony interface.
- 501 Not Implemented - The Vega received a SIP request with a method it does not recognise.

502 Bad Gateway

503 Service Unavailable - Includes Vega Congested.

504 Server Time-out

505 Version Not Supported - The Vega received a SIP request with a version other than "SIP2.0".

513 Message Too Large

#### **15.10.6 6xx - SIP Global Failure Codes Supported (Generated and Responded To)**

The Vega responds to 6xx responses by terminating the call.

6xx responses generated by the Vega are:

600 Busy Everywhere

603 Decline - The Vega declined the request (in response to a REFER request).

604 Does Not Exist Anywhere

606 Not Acceptable - If the Vega had previously sent a T.38 Fax INVITE, it will try again with a G.711 INVITE



## 16 ENHANCED NETWORK PROXY

ENP (Enhanced Network Proxy) is a license enabled feature (i.e. requires a special license key to be applied to the product). Please contact the supplier of your product to obtain an ENP license key. ENP was previously referred to as VRP (Vega Resilient Proxy) in earlier firmware releases.

### 16.1 Description

The Enhanced Network Proxy feature (ENP) greatly extends the capabilities of a gateway product by including SIP proxy functionality within a single device.

ENP's principle functions are twofold:

- To provide resilience for local SIP UA's in case of loss of contact with ITSP proxy.i.e. Through broadband failure, or loss of ITSP network connection.
- To allow some calls that would normally always route to the ITSP to route to other devices. These can include the local gateway (hosting ENP) or other gateways or SIP devices.

### 16.2 ENP's Modes Of Operation

ENP can be configured to operate in three different modes (or disabled):

- standalone\_proxy
- forward\_to\_itsp
- itsp\_trunking
- off

Configuration via the Web User Interface:

*Expert Config > SIP Proxy > SIP Proxy Configuration > Mode*

Configuration parameter:

`sipproxy.mode`

#### 16.2.1 Standalone Proxy Mode

In this mode the ENP behaves as a 'stand alone' SIP Registrar and Proxy. The ENP can be used for simple registration and proxy operations, enabling SIP devices to call one another, make (or receive) calls via the gateway (for example to the PSTN or a PBX).

The ENP in standalone mode will support up to 120 attached (registered) endpoints (SIP devices). The ENP supports basic call routing and SIP transfers, but does not provide more enhanced PBX features such as Voice Mail.

Devices that wish to register to the ENP must either be defined as a SIP Proxy Auth User or have an i.p. address defined in the Trusted IP Address table.

Devices defined as SIP Proxy Auth User's will be challenged for authentication, whereas devices with i.p. addresses defined in the Trusted IP Address table will not be challenged for authentication (they will just register).

Additionally Trunk Gateways (TGWs) can be defined. This enables calls to be routed to (and from) TGWs without the need for the TGW's to register as endpoints. See further information regarding TGW's below.

### 16.2.2 Forward To ITSP Mode

In this mode the ENP has one (or more) SIP ITSP Proxies defined in its configuration. All local (to the ENP) SIP devices are configured to use the ENP as their outbound proxy. All SIP messaging is sent via the ENP to the ITSP Proxy, and successful registrations are cached by the ENP.

Should the connection to the ISTP Proxy fail (the ENP continuously checks availability by sending SIP OPTIONS messages) then all local devices with cached registrations will still be able to communicate via the ENP. Once the ISTP Proxy connection is restored all SIP messaging is (once again) sent via the ENP to the ITSP.

If a call is received and routing is configured such that a particular call is destined for a TGW then the SIP messaging is forwarded to the TGW. See further information regarding TGW's below.

### 16.2.3 ITSP Trunking Mode

In this mode the ENP behaves similarly to the *forward\_to\_itsp* mode, however if a call is received and is destined for a locally registered endpoint (Trusted IP Address, SIP Proxy Auth User or TGW) then the SIP messaging will not be sent to the ISTP – it will be routed directly to the local endpoint destination (including TGWs).

## 16.3 ENP Configuration Details

### 16.3.1.1 ENP's Realm

The ENP's Realm should (in the case of working with an ITSP) be configured as the ITSP realm/domain (i.e. myitsp.com). In the *'stand\_alone'* mode the realm could be the i.p. address of the gateway.

Configuration via the Web User Interface:

*Expert Config > SIP Proxy > SIP Proxy Configuration > Realm*

Configuration parameter:

`siproxy.realm`

### 16.3.1.2 ENP's Rx Port

The ENP's Rx (receive) Port should be different to the gateway's Local SIP Port (configured in the gateway's SIP settings). It is useful to consider the ENP as a separate device to the gateway which shares its i.p. address with the gateway, but is addressed using a different i.p. port.

When the gateway is sending SIP messaging to the ENP it can address it using the local loopback address of 127.0.0.1 and the ENP's Rx Port.

Configuration via the Web User Interface:

*Expert Config > SIP Proxy > SIP Proxy Configuration > Rx Port*

Configuration parameter:

```
siproxy.rx_port
```

### 16.3.1.3 How Can I Tell Who Is Registered To The ENP?

All registered users (registered to the ENP, possibly to an ITSP too – if set to '*forward\_to\_itsp*' mode) can be seen in the Web User Interface:

*Expert Config > SIP Proxy > SIP Proxy Configuration > SIP Proxy Registered Users*

The following CLI command will also show registered users:

```
siproxy show reg
```

### 16.3.1.4 SIP Proxy Auth Users

SIP Proxy Auth Users (as described above) are sip endpoints which are able to register directly with the ENP. In *forward\_to\_itsp* mode endpoints do not necessarily need to be defined as authentication users – all registration requests are forwarded to the ITSP (if they are successful, then the registration details will be cached in the ENP, ready to be used in the case of failure of the ITSP link).

If the ENP is in *forward\_to\_itsp* or *itsp\_trunking* modes then when the endpoint registers to the ENP, the ENP will forward the registration messages to the ITSP. Should the ITSP reject the registration then the endpoint will not be registered to the ENP (even if the SIP Proxy Auth User information matches the endpoints registration request).

SIP Proxy Auth Users can be defined (and created) via the Web User Interface:

*Expert Config > SIP Proxy > SIP Proxy Configuration > SIP Proxy Authentication Users*

The following configuration parameters define a Sip Proxy Auth user (where x is the index of the SIP Proxy Auth User, i.e. 1,2,3 etc.):

<code>siproxy.auth.user.x.aliases</code>	(see below)
<code>siproxy.auth.user.x.enable</code>	(overall activation of SIP Proxy Auth User)
<code>siproxy.auth.user.x.password</code>	(SIP Proxy Auth User password – same as ITSP if ITSP is used)
<code>siproxy.auth.user.x.username</code>	(SIP Proxy Auth User username – same as ITSP if ITSP is used)

### 16.3.1.5 SIP Proxy Auth User Aliases

Some ITSP's register using a different number from the PSTN number assigned to that device / SIP user account. The ENP can support these user aliases, so (for example) in the event of an ITSP failure other registered users can continue to call endpoints using the alias numbers.

Additionally the ENP can be configured to always use aliases to route calls to endpoints.

SIP Proxy Auth Users Alias control can be defined via the Web User Interface:

*Expert Config > SIP Proxy > SIP Proxy Configuration > SIP Proxy Authentication Users > Use Aliases*

The following configuration parameter defines the ENP behaviour regarding aliases

```
sipproxy.auth.user.use_aliases
```

### 16.3.1.6 SIP Proxy IP Filters

The following SIP Proxy IP Filters exist in the ENP:

- Ignored IP Addresses
- Rejected IP Addresses
- Trusted IP Addresses

### 16.3.1.7 SIP Proxy IP Filters – Ignored IP Addresses

SIP devices which signal the ENP using source i.p. addresses which are within a range defined as 'ignored' will not be responded to. This is to prevent SIP 'spamming' – where some device is attempting to access (register to) the ENP to illegally gain access.

SIP Proxy Ignored IP Addresses can be defined via the Web User Interface (in ranges of i.p. addresses):

*Expert Config > SIP Proxy > SIP Proxy Configuration > SIP Proxy IP Filters > Ignored IP Addresses*

The following configuration parameters define the SIP Proxy IP Filter – Ignored IP Addresses (where x is the index of the Ignored IP Address range, i.e. 1,2,3 etc.):

```
sipproxy.ignore.x.enable (overall control of ignored range index)
```

```
sipproxy.ignore.x.ipmax (i.p. range minimum value)
```

```
sipproxy.ignore.x.ipmin (i.p. range maximum value)
```

### 16.3.1.8 SIP Proxy IP Filters – Rejected IP Addresses

SIP devices which signal the ENP using source i.p. addresses which are within a range defined as 'rejected' will have their signalling requests actively rejected (with a SIP Forbidden response).

SIP Proxy Rejected IP Addresses can be defined via the Web User Interface (in ranges of i.p. addresses):

*Expert Config > SIP Proxy > SIP Proxy Configuration > SIP Proxy IP Filters > Rejected IP Addresses*

The following configuration parameters define the SIP Proxy IP Filter – Rejected IP Addresses (where x is the index of the Rejected IP Address range, i.e. 1,2,3 etc.):

`sipproxy.reject.x.enable` (overall control of reject range index)  
`sipproxy.reject.x.ipmax` (i.p. range minimum value)  
`sipproxy.reject.x.ipmin` (i.p. range maximum value)

#### 16.3.1.9 SIP Proxy IP Filters – Trusted IP Addresses

By default, SIP devices with i.p. addresses which are not defined in any SIP Proxy IP Filter will have their registration requests (in the case of `fwd_to_itsp` and `itsp_trunking` modes) forwarded to the ISTP. It is up to the ITSP to challenge requests for authentication (which it may be configured not to do).

If the link to the ITSP fails then the ENP will have responsibility for challenging requests for authentication, so any devices which are not able to perform authentication functions will not be able to process calls.

Defining a SIP device's i.p. address in the trusted i.p. address range allows these devices to register to the ENP without any authentication challenges. If the ENP is in `stand_alone` mode a 'trusted' device will be allowed to register to the ENP without any challenges for authentication.

SIP Proxy trusted IP Addresses can be defined via the Web User Interface (in ranges of i.p. addresses):

*Expert Config > SIP Proxy > SIP Proxy Configuration > SIP Proxy IP Filters > Trusted IP Addresses*

The following configuration parameters define the SIP Proxy IP Filter – Trusted IP Addresses (where *x* is the index of the Trusted IP Address range, i.e. 1,2,3 etc.):

<code>sipproxy.trust.x.enable</code>	(overall control of trusted range index)
<code>sipproxy.trust.x.ipmax</code>	(i.p. range minimum value)
<code>sipproxy.trust.x.ipmin</code>	(i.p. range maximum value)

### 16.3.1.10 SIP ITSP Proxies

The ENP can be configured to use a single, or multiple, ISTP proxies when in *forward\_to\_itsp* or *itsp\_trunking* modes.

SIP Proxy SIP ITSP Proxies can be defined via the Web User Interface:

*Expert Config > SIP Proxy > SIP Proxy Configuration > SIP ITSP Proxies*

The following configuration parameters define the SIP Proxy SIP ITSP Proxies (where *x* is the index of the SIP Proxy SIP ITSP Proxy, i.e. 1,2,3 etc.):

<code>sipproxy.itsp_proxy.x.enable</code>	(overall activation of ITSP connection usage)
<code>sipproxy.itsp_proxy.x.ipname</code>	(i.p. address or resolvable name)
<code>sipproxy.itsp_proxy.x.port</code>	(i.p. port to send SIP messages to ITSP proxy)

### 16.3.1.11 SIP ITSP Proxy Availability Test

By default the ENP checks for the availability of the ITSP proxy by sending SIP OPTIONS messages to the remote platform(s) (every 30 seconds). BYE messages can also be used to poll for availability – this option is useful for those SIP devices that do not respond to OPTIONS messages (e.g. Microsoft OCS).

If a response is not received the ITSP proxy is deemed 'down'. If there are no available proxies then the ENP behaves in failover mode, and allows locally registered endpoints to communicate despite the unavailability of the ITSP proxy.

When in failover mode the ENP continues to test for ITSP proxy availability (by sending SIP OPTIONS messages), should a response be received the ENP declares the ITSP as available (up) and will once again route SIP messages to the ITSP.

SIP Proxy SIP ITSP Proxies Availability Test can be controlled (enabled or disabled) via the Web User Interface:

*Expert Config > SIP Proxy > SIP Proxy Configuration > SIP ITSP Proxies > Proxy Test*

The following configuration parameter defines whether the SIP Proxy test is enabled:

```
siproxy.itsp_proxy.accessibility_check
```

Note – the signalling transport for the OPTIONS messages is also configurable (between UDP and TCP) but only via the command line, using the following parameter:

```
siproxy.itsp_proxy.options_transport
```

Additionally, the following CLI command can be used to show the status of the remote proxies (from the perspective of the ENP):

```
siproxy status
```

### 16.3.1.12 Using Multiple SIP ISTP Proxies

When multiple ITSP proxies are defined they can be used in three different modes:

- *normal*
- *cyclic*
- *dnssrv*

When set to *normal* mode (and if the SIP ISTP proxy is available) the ENP will use the first defined SIP ITSP proxy. Should this primary SIP ITSP proxy become unavailable the ENP will use the next available defined SIP ISTP proxy. Should there be no available SIP ITSP proxies the ENP will go into failover mode.

When set to *cyclic* mode the ENP will use the defined available SIP ITSP proxies in a cyclic order – i.e. if there are three available proxies the ENP will use proxy 1, then proxy 2, then proxy 3 and then proxy 1 again.

When set to *dnssrv* mode the ENP expects only a single SIP ITSP proxy to be defined in its configuration. When the ENP tries to resolve the SIP ITSP proxy name the DNS server should respond with available (multiple) proxy addresses with appropriate weighting for each. The ENP sends OPTIONS messages to all the resolved SIP ITSP proxies to determine availability, and respects the weighting set by the DNSSRV response for SIP traffic routing.

SIP Proxy SIP ITSP Proxies Mode can be configured via the Web User Interface:



*Expert Config > SIP Proxy > SIP Proxy Configuration > SIP ITSP Proxies > Mode*

The following configuration parameter defines what multiple SIP ITSP proxy mode is to be used:

```
sipproxy.itsp_proxy.mode
```

#### **16.3.1.13 SIP ITSP Proxies Signalling Transport**

The signalling transport used for communication with the ITSP is configurable (between UDP and TCP transports).

SIP Proxy SIP ITSP Proxies Transport can be configured via the Web User Interface:

*Expert Config > SIP Proxy > SIP Proxy Configuration > SIP ITSP Proxies > Transport*

The following configuration parameter defines what SIP ITSP proxy transport is to be used:

```
sipproxy.itsp_proxy.sig_transport
```

#### **16.3.1.14 SIP Proxy Trunk Gateways**

TGW's can be considered as SIP UA's (user agents) that can have calls routed to / from the ENP. The principle difference between a TGW and registered endpoints is that TGW's routing is based on routing rules defined in the ENP (where particular called numbers are routed towards the TGW), not by virtue of being a registered endpoint.

TGW's can:

- have availability checked using SIP OPTIONS messages (similar to ITSP Proxies).
- be forced to authenticate with the ENP (similar to registered endpoints).
- be utilised in a routing only, cyclic or weighted (dnssrv) modes.

TGW's are classified as either PSTN TGW's or Local TGW's. There are certain routing restrictions applied to PSTN TGW's to prevent call looping in PSTN networks.

When a TGW is classified as a PSTN TGW the following routing restrictions apply:

- calls from PSTN gateways cannot be routed to other PSTN gateways
- calls from PSTN gateways cannot be routed to the ITSP
- calls from unregistered users (even if "trusted") cannot be routed to PSTN gateways

By default the gateway hosting the ENP is considered as a PSTN TGW, and appears in the default configuration (with the i.p. address of 127.0.0.1) as the first defined TGW. This first TGW definition is not configurable.

SIP Proxy Trunk Gateways can be defined via the Web User Interface:

*Expert Config > SIP Proxy > SIP Proxy Configuration > Trunk Gateways*

The following configuration parameters are used to define a TGW (where x is the index of the TGW, i.e. 2,3 etc. Note: `trunk_gw.1` is not configurable):

<code>siproxy.trunk_gw.x.enable</code>	(overall activation of TGW)
<code>siproxy.trunk_gw.x.ipname</code>	(i.p. address or resoveable name)
<code>siproxy.trunk_gw.x.is_pstn_gw</code>	(flags if TGW is defined as a PSTN TGW)
<code>siproxy.trunk_gw.x.port</code>	(i.p. receive port of the TGW)

Further Trunk Gateway configuration can be defined via the Web User Interface:

*Expert Config > SIP Proxy > SIP Proxy Configuration > Trunk Gateways*

The following configuration parameters are used to define additional TGW controls:

`siproxy.trunk_gw.accessibility_check`

(controls use of SIP OPTIONS or BYE messages to check TGW availability)

```
siproxy.trunk_gw.allow_itsp_calls_to_pstn
```

(controls ability for ITSP calls to be routed to PSTN TGWs)

```
siproxy.trunk_gw.from_action
```

(controls whether TGWs are 'trusted' (do not register), required to authenticate, actively rejected or ignored)

```
siproxy.trunk_gw.mode
```

(controls mode in which TGWs can be load shared – or not)

```
siproxy.trunk_gw.options_transport
```

(controls signalling transport for SIP OPTIONS messages)

```
siproxy.trunk_gw.sig_transport
```

(controls signalling transport for TGW SIP messages)

There are two additional 'routing restriction' configuration parameters available which control routing towards the ITSP when the ENP is configured in *forward\_to\_itsp* mode.

```
siproxy.trunk_gw.forward_to_itsp_mode.allow_local_trunk_calls_to_itsp
```

```
siproxy.trunk_gw.forward_to_itsp_mode.allow_pstn_calls_to_itsp
```

by default both of these parameters are set to 'never'.

### 16.3.1.15 Trunk Gateway Call Routing

Routing of calls towards the TGWs is defined as a series of routing 'plans', where call routing decisions can be made based on the following call attributes:

- TEL: (called number)
- TELC: (calling number)
- TAC: (calling i.p. address)

If a call is received that matches a routing plan (i.e. the called number matches the TEL: call attribute in a routing rule) then the call is routed to a defined TGW (or to a single TGW from a defined list of TGWs).

Where a list of multiple TGWs is defined in a routing rule (in a comma separated list), the choice of which TGW to use can be defined as:

- linear\_up (i.e. the first TGW defined in the list of TGWs is routed to first – if the call fails or the TGW is unavailable the second defined TGW is used etc.)
- equal (i.e. all defined TGWs are routed to equally – pseudo randomly)
- weighted (i.e. 60:40 for two defined TGWs)

The range of SIP error responses which trigger a re-attempt to the next available TGW can be defined (by default 500-599 responses will trigger the ENP to attempt a call to the next available TGW).

Trunk Gateway Call routing can be configured via the Web User Interface:

*Expert Config > SIP Proxy > SIP Proxy Configuration > Trunk Gateway Call Routing*

The following configuration parameters are used to define the Trunk Gateway Call Routing (where *x* is the routing plan index, i.e. routing rule 1,2,3):

```
siproxy.trunk_gw.plan.x.dest
```

(Call attributes, if matched use this routing plan)

```
siproxy.trunk_gw.plan.x.enable
```

(Overall activation of the routing plan)

`siproxy.trunk_gw.plan.x.gw_list`

(Comma separated list of TGW id's)

`siproxy.trunk_gw.plan.x.name`

(A name assigned to the plan)

`siproxy.trunk_gw.plan.x.redirection_responses`

(The range of error responses on which to attempt the call to the next TGW)

`siproxy.trunk_gw.plan.x.routing_rule`

(TGW routing rule – i.e. *linear\_up*, *equal* or *weighted* – i.e. 20:30:50)

#### 16.3.1.16 PSTN Gateway Fallback

In *stand\_alone* mode if a call is received from a TGW or a registered endpoint and the called number is not a registered endpoint and there is no matching TGW routing, the call will be routed out to the PSTN Fallback Gateway.

In *forward\_to\_istp* or *itsp\_trunking* modes if a call is received from a local TGW or a registered endpoint and the called number is not a registered endpoint and there is no matching TGW routing, the call will be routed out to the PSTN Fallback Gateway.

The PSTN Fallback Gateway can be defined as all gateways defined in the TGW list or a list of specified TGW identifiers (with the same routing decision rules as in the TGW routing – i.e. *linear\_up*, *equal* or *weighted* (i.e. 20:80).

The range of SIP error responses which trigger a re-attempt to the next available PSTN TGW can be defined (by default 500-599 responses will trigger the ENP to attempt a call to the next available PSTN TGW).

### **16.3.1.17 Checking If Unit Has SIP PROXY License**

ENP is a licensable feature, in other words a special license key must be applied to the gateway to enable the ENP feature to be used.

To check if the gateway has the appropriate license key from the CLI type:

```
upgrade
```

```
license
```

In the output ensure that the active license key confirms that the SIP PROXY feature is available:

```
system licensed for SIP PROXY
```

## 17 SNMP MANAGEMENT

Vega gateways contain an SNMP server that is compatible with SNMP versions 1 and 3, supporting MIB-1 and MIB-2 definitions. The Vega will also generate SNMP traps on key system events.

### 17.1 SNMP Configuration

To enable SNMP the following information will need to be configured:

```
[snmp.mib2.system] ; basic SNMP system details
  sysContact      ; contact name for this Vega
  sysLocation     ; location details for this Vega

[snmp.mib2.managers.n]; definition of who is allowed to manage the Vega
  ip              ; manager's ip address
  subnet         ; mask to identify significant part of manager's IP
                  ; address to check
  community      ; community name (one of the mib2.communities.m.name)
  support_snmpv3 ; Enable / disable SNMP V3 support (disabled = v1)

[snmp.mib2.communities.m]; list of available communitie
  name           ; community name
  get            ; get allowed (1=yes, 0=no)
  set           ; set allowed (1=yes, 0=no)
  traps         ; traps allowed (1=yes, 0=no)
```

A list of allowed managers must be configured as only members of this closed user group are allowed access to the SNMP variables and can receive SNMP traps. The contact and location details can be altered using the corresponding SNMP set commands via a manager.

### 17.2 SNMP Enterprise Object-ID

The VegaStream Object-ID for Vega gateways is: 1.3.6.1.4.1.4686.11

1 (ISO).3 (organisations).6 (dod).1 (IAB Administered).4 (private).1 (enterprises).4686 (enterprise ID - VegaStream).11 (Vega)

### 17.3 Trap Support

Support is available for the following traps:

Trap Number	Definition
0	System Cold Boot
1	System Warm Boot
2	Link Down
3	Link Up
4	Authentication Failure
6	Enterprise specific – see "specific codes" for details

***For details of the enterprise specific trap "specific codes" and for further details on SNMP, see Information Note "IN 08 – SNMP management"***

## 18 UPGRADES AND MAINTENANCE

### 18.1 Upgrading the Vega Firmware

Upgrading firmware is a relatively easy task. Full upgrade instructions are provided along with the firmware file itself, normally in the same zipped folder. See [www.vegaassist.com](http://www.vegaassist.com) for further information on how to obtain new firmware.

### 18.2 The Boot-time Recovery Menu

Vega Boot code supports a couple of disaster recovery functions to assist the user in extreme circumstances.

NOTE

Use of these functions can seriously affect the configuration of your Vega - Only use these functions under the direction of your supplier

To access the boot menu you will need the following:

Straight through DB9 to RJ45 RS-232 serial cable

Terminal DTE or PC based terminal emulator application (like Microsoft Hyper Terminal) configured for 9600 bps, 8/N/1

Power the Vega off and then on, and in the first 10 seconds press and hold the enter key on the terminal/emulator application keyboard. A message will appear saying "Press Y for boot menu".

At this point press the "Y" key, and a menu will appear with the following options:

Reset System Configuration and Clear Passwords

Switch Active Boot Partition

Exit boot menu

#### 18.2.1 Reset System configuration and Clear Passwords

Select "Reset System Configuration and Clear Passwords" from the menu, and press "Y" to confirm your choice. The configuration and passwords on the Vega will be reset back to factory defaults.



**WARNING!**

**Unlike the FACTORY RESET command, this BOOT MENU operation will erase ALL data in the Vega, and restore ALL settings back to factory default values (including, for example, lan.if.x.ip and all passwords). Any license applied will also be removed. This could result in severe loss of service.**

#### 18.2.2 Switch Active Boot Partition (- Reverting to a Previous Firmware Image)

Select "Switch Active Boot Partition" from the menu. A list of up to two runtime images will then be displayed, labelled 1. and 2., with their corresponding firmware version and build details. The current partition will be displayed as "CURRENT". To switch to the other runtime partition select the appropriate number and then confirm your choice.



There will be a pause while partitions are swapped and then the Vega will automatically re-boot in order to start running from this partition.

NOTE

You should carry out a factory reset after a change in firmware partition to ensure that all parameters are appropriately initialised for this version of code.

## 19 AUTOEXEC SCRIPT

The autoexec script function allows a Vega to automatically upgrade its firmware and configuration on power up and re-boot. The contents of the autoexec script file defines the exact operations that the Vega will make.

This script is downloaded as a file from a server (e.g. tftp, ftp, http or https) and executed. The collection and execution of autoexec files is triggered by:

- Power on
- Reboot
- Scheduled autoexec
- SIP Notify

Trying to collect and execute an autoexec file at power on and Vega reboot is enabled by default; scheduled autoexec needs to be configured.

The method for collecting the autoexec file (tftp, ftp, http, https) will be dependent on the setting of `lan.file_transfer_method`. If it succeeds it will then execute the commands within that script file.

Also see the document IN\_42-Vega\_Provisioning available on [www.VegaAssist.com](http://www.VegaAssist.com)

### 19.1 The Script File

The script file contains a set of CLI commands that are executed on boot-up.

While the script file can run most CLI commands, the script file typically contains:

- 1) A CLI command to download a specific firmware.
- 2) A CLI command to load a specific configuration.
- 3) Optionally, a few CLI commands to set some specific config parameters.

The script file is not intended to contain more than a few lines of configuration data and must be less than 512 bytes.

### 19.2 A Typical Script File

```
upgrade
download enable
download firmware vega50pwisc.abs reboot ifnew
exit
get config2.txt save reboot ifdiff
```

This script file will make sure that the Vega will load the `vega50pwisc.abs` firmware and the `config2.txt` configuration file.

NOTE
------

There MUST be a blank line after the last command line in the autoexec script file as the Vega needs to see the Carriage Return at the end of the command line in order to execute the command.

### 19.3 Script File - Permitted Command Set

For security reasons, the command set for the script file is a subset of the full Vega command set, for instance it is not possible to change the password from the script file. Commands that are supported include:

- APPLY
- BILL [OFF|ON|Z|CLEAR]
- BILL DISPLAY [OFF|ON]
- BLOCK CALLS
- BOOT MANAGER
- CD
- CLEAR STATS
- CP
- DELETE
- DOWNLOAD ENABLE
- DOWNLOAD BOOT
- DOWNLOAD FIRMWARE
- GET
- NEW
- ON ERROR BLOCK
- ON ERROR RUN
- PART1
- PART2
- PURGE
- PUT
- SAVE
- SET
- SHOW BANNER
- SHOW BILL
- SHOW CALLS
- SHOW HOSTS
- SHOW PORTS
- SHOW STATS
- SHOW VERSION
- TGET
- TPUT
- UNBLOCK CALLS
- UPGRADE

### 19.4 CLI Command Extensions

In order to allow commands to be processed conditionally, a number of extensions to existing commands have been implemented:

```
(1) get config.txt ifdiff
```

Same as `get` but before loading the configuration the Vega checks the version of the new configuration file against that specified at `_advanced.autoexec.lastconfig`. The configuration file is only loaded if the version is different.

In a file that has been created using the Vega's "put" or "tput" command, the configuration version is identified by the VEGACONFIGVERSION header at the head of the file:

```

;
; Script generated using
; PUT hel.txt <all>
; VEGACONFIGVERSION:Vega50WISC:01/01/1999 00:03:00
;

```

Therefore, if the ifdiff parameter is specified, if `_advanced.autoexec.lastconfig` is "Vega50WISC:01/01/1999 00:03:00", then the config will not be loaded.

```
(2) get config.txt save reboot ifdiff
```

Same as the "get config.txt ifdiff" except that if the get is performed the Vega will save the config and then reboot.

```
(3) get config.txt save rebootifneeded ifdiff apply
```

Same as the "get config.txt save reboot ifdiff" except that the reboot will only occur if there are config variables that have changed that need the Vega to be rebooted to activate them.

'apply' is necessary to apply parameters if the reboot is not needed.

```
(4) get config.txt save rebootifneededwhenidle ifdiff apply
```

Same as the "get config.txt save rebootifneeded ifdiff" except that if the reboot is needed it will be delayed until there are no calls in progress on the Vega.

```
(5) download firmware vega50pwisc.abs ifnew
```

Same as "download firmware" but before loading the code the Vega checks the version of code on the sever against the current version. The firmware will only be loaded if the code on the server is newer.

The current version is shown when you do "show version":

```

e.g.
Version: 04.02.04
Built: May 9 2001 14:42:14 T001

```

In a version description there is:

```

Version: <HW>.<SWmaj>.<SWmin>
Built: <Date> <Time> T<BuildTag>

```

The <Date> and <Time> fields are not checked but the other fields (in order of importance, most important first) are :

```

<HW>           - hardware version
<SWmaj>        - firmware major version
<SWmin>        - firmware minor version
<BuildTag>     - tag ID which together with <HW>, <Swmaj> and <Swmin> make
                  this build ID unique

```

Format of fields (lowest value first):

```

<HW>           - 01, 02, 03, etc.
<SWmaj>        - 01, 02, 03, etc.

```

<SWmin> - 01, 02, 03, etc.  
 <BuildTag> - 001, 002, 003, etc.

If the "ifnew" directive is specified, the following checks are performed in the following order:

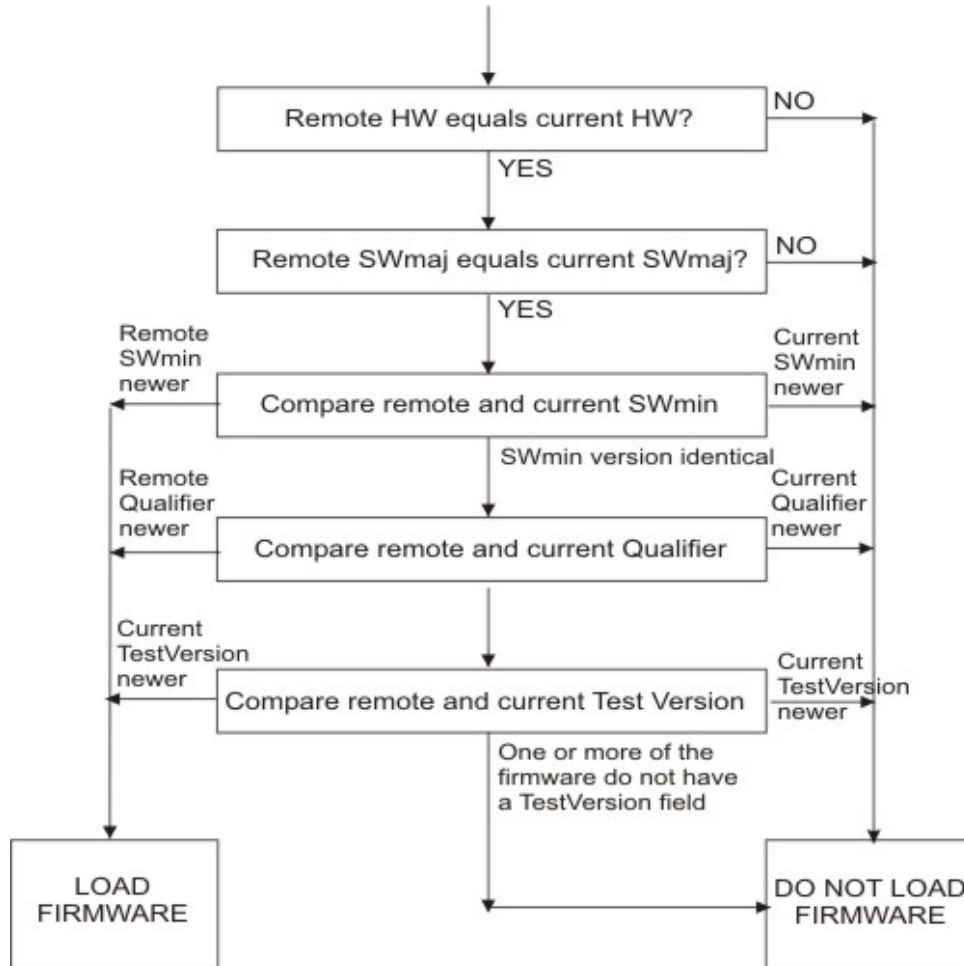

(6) download firmware vega50pwisc.abs ifdiff

Same as "download firmware" but before loading the code the Vega checks the version of the code on the server against the current version. The firmware will only be loaded if the code version on the server is different.

(7) download firmware vega50pwisc.abs reboot ifnew

Same as "download firmware vega50pwisc.abs ifnew" except that if the download is performed the Vega will automatically reboot.

(8) download firmware vega50pwisc.abs reboot ifdiff

Same as "download firmware vega50pwisc.abs ifdiff" except that if the download is performed the Vega will automatically reboot.

## 19.5 Configuring Autoexec Parameters

The default configuration is:

```
[_advanced.autoexec]
    enable=1
    lastconfig=none
    scriptfile1=%iscript.txt
    scriptfile2=defaultscript.txt
```

Term	Description
enable	The Vega will only try to fetch a script file if this is set to '1'.
lastconfig	The version of the last successfully loaded configuration file – this is updated by the vega based on the last configuration loaded; there is no need to alter this parameter.
scriptfile1	The first file containing the commands to be executed on boot up.
scriptfile2	If the Vega can't find scriptfile1 then it will try scriptfile2.

## 19.6 Scriptfile Name – Expandable Characters

In "\_advanced.autoexec.scriptfile1" and "\_advanced.autoexec.scriptfile2", the expandable characters %i and %n can be used:

%i	Expands to the ip_address of the Vega. So, if the Vega's IP address is aaa.bbb.ccc.ddd then "%i" will become "aaa_bbb_ccc_ddd". The IP address is taken either from "lan.if.1.ip" in the configuration or from that obtained via DHCP (for Lan interface 1).
%m	Expands to the MAC address of the Vega.
%n	Expands to the hostname of the Vega. The hostname is specified by "lan.name" in the configuration.
%p	Expands to the product type as shown in show banner, e.g. VEGA400 and VEGA-6x4

e.g. if

```
[_advanced.autoexec]
    scriptfile1=vega_%i_cfg.txt
```

and the ip address of the vega is 192.168.1.102, then autoexec will look for a file vega\_192\_168\_1\_102\_cfg.txt on the tftp or ftp server.

## 19.7 Status Reporting

To report the success or failure of the firmware and configuration parameter loading, Vegas use Alert log messages and SNMP "enterprise-specific" traps. The traps show up as:

```
trap objectID=enterprises.4686.11 and
trap specific code=x,
```

where x is the specific code for the enterprise trap (see Information Note "IN-08 SNMP management" for values).

For example, on the CastleRock SNMP manager enterprise traps are displayed in the form:

```
enterprises.4686.11.6.x
```

## 19.8 Example Sequence of Events

For the following script file:

```
upgrade
download enable
download firmware vega50pwisc.abs reboot ifnew
exit
get config2.txt save reboot ifdiff
```

The full sequence of events of an error-free execution of the above script is:

- 1) The Vega will fetch the script file from the ftp or tftp server
- 2) The Vega will download the new firmware if it is newer than the current version.

**\*\* VEGA WILL REBOOT \*\***

- 3) The Vega will fetch the script file again.
- 4) It won't download the firmware because the firmware is already up-to-date (server version of firmware is no longer newer).
- 5) It will load the config file config2.txt if it is different to the current loaded version.
- 6) The config will be saved.

**\*\* VEGA WILL REBOOT \*\***

- 7) The script file will be fetched again.
- 8) The vega won't do the firmware download.
- 9) The vega won't do the config load.
- 10) The vega starts normal operation.

Once step 10 has been reached, if the Vega is rebooted again, the traps sent out by the Vega will be:

```
enterprises.4686.1.6.22    firmware not loaded because it isn't new
enterprises.4686.1.6.21    config not loaded because the version isn't different
```

## 19.9 SIP Notify triggered autoexec

Using a SIP notify, the Vega can be requested to download and execute an autoexec file. The structure of the autoexec is:

```
SIP m:1480342 141002 00009<-- UA RX --- From UDP(18):172.19.1.233:5060
NOTIFY sip:service@172.19.1.230:5060 SIP/2.0
Via: SIP/2.0/UDP 192.168.0.1:5060;branch=z9hG4bK-14823-1-0
From: sipp <sip:sipp@192.168.0.1:5060>;tag=14823SIPpTag001
To: sut <sip:service@172.19.1.230:5060>
Call-ID: 1-14823@192.168.0.1
CSeq: 1 NOTIFY
Contact: sip:sipp@192.168.0.1:5060
User-Agent: Provisioning
Event: ua-profile
Max-Forwards: 70
MIME-Version: 1.0
Content-Type: message/external-body; access-type="URL";
URL="http://Steve/VegaStream/005058040070_notify.txt";
Content-Length: 0
```

This requests the Vega to download and execute the autoexec file `/Steve/VegaStream/005058040070_notify.txt` from an http server.

When the Notify is received, the Vega will ask for authentication to ensure that only authorised requests may cause the Vega to download new configuration.

For details on how to configure SIP Notify handling, see the document `IN_42-Vega_Provisioning` available on [www.VegaAssist.com](http://www.VegaAssist.com)





## 20 WORKING WITH FIREWALLS

The main job of a firewall is to block LAN traffic that is not known to be acceptable. One of the major problems that VoIP introduces to firewall protection is the number of IP port numbers that the protocol specifies as valid for carrying the media. Unless the Firewall is VoIP aware and can open and close IP port numbers based on the protocol messages, the port number range that needs to be left open (i.e. unprotected) is that specified by the RTP spec, 10,000 to 20,000.

In order to reduce the size of the hole that must be opened in the firewall, the Vega can be configured to use a more limited subset of IP port numbers for receiving RTP media traffic. When it specifies the IP port number for the far end device to send the media to, it looks in its configuration parameters for the range of values it has been configured to use. By default the range 10,000 to 20,000 is configured (as per the RTP specification).

If a lesser range is required, the Vega can be configured with up to 10 blocks of port numbers, allowing “islands” of non-intersecting port numbers to be used for the media.

For example if the ranges 10,000 to 10,249 and 11,000 to 11,249 are to be used for media, then configure the Vega as follows:

```
[_advanced.lan.port_range.1]
    max=10249
    min=10000
    name=rtp_range1
    protocol=udp

[_advanced.lan.port_range.6]           // used 6 as 2..5 are defined by default
    max=11249
    min=11000
    name=rtp_range2
    protocol=udp

[_advanced.lan.port_range_list.1]
    list=1,6                           // _advanced.lan.port_ranges 1 & 6 = rtp ports
    name=rtp_ports

[_advanced.media]
    rtp_port_range_list=1               // rtp port list defined by _advanced.lan.port_range_list.1
```

### NOTE

The defined range must allow room for both RTP connections and RTCP connections. By definition an RTP port is an even numbered port and the associated RTCP port is the next higher odd numbered port. To avoid problems of lack of RTP/RTCP ports for media, the minimum number of ports that must be supported over all the *first* / *last* blocks must be 2 \* Vega ports.

To ensure that each RTP port can be used (because there is an associated valid RTCP port) always make *first* an even number and *last* an odd number.

### 20.1 NAT

NAT – Network address translation, is typically used to “hide” a network of private IP addresses behind one or more public IP addresses. A NAT device changes the IP address and often the IP

port number of the IP messages as they cross it. This causes problems to VoIP systems as the VoIP protocol contains references to explicit IP addresses and port numbers, which typically do not get translated.

Vega gateways have configuration parameters that allow it to operate with statically configured NAT devices. This functionality allows the Vega to pre-change the in-protocol IP address and port number information, so that they are consistent with the changes that the NAT device will make to the message headers.

***For further details on the problems of NAT, and for details on how to configure the Vega to work with statically configured NAT devices, see information note "IN 14 NAT handling"***

## 21 QUALITY OF SERVICE (QOS)

Quality of Service is a whole network requirement. All switches / routers and other devices in the LAN path as well as the endpoints must support and be configured correctly to support QOS, otherwise any point that does not properly support QOS will be the weak link that loses or delays packets and ruins the quality for the whole system.

It is up to end-points – like Vegas – to mark LAN packets appropriately so that the in-network routers can give them the priority over other less time critical data transfers.

Vegas support QOS marking of LAN packets. They also support the generation of QOS reports and the monitoring and logging of QOS events.

### 21.1 QOS marking of LAN packets

Vega units support the configuration of both i) Type of Service/Diffserv field in the IP header, and ii) 802.1p/q fields in the Ethernet header.

 <b>WARNING!</b>	<p><b>802.1 Ethernet packet headers are 4 bytes larger than standard Ethernet headers, and so use of 802.1p/q may not be backward compatible with existing Ethernet systems – only enable 802.1 p/q functionality on your Vega if your network supports these LAN packets, otherwise you may lose LAN connection with it.</b></p>
------------------------------------------------------------------------------------------------------	-----------------------------------------------------------------------------------------------------------------------------------------------------------------------------------------------------------------------------------------------------------------------------------------------------------------------------------

#### 21.1.1 Layer 3 (IP header) – Type Of Service bits

Vegas support the configuration of Internet Protocol Header Type Of Service (TOS) value. This is a layer 3 value that LAN routers and switches can use to determine the priority of the IP packet in comparison to other suitably tagged packets.

Configuration of Type Of Service parameters is performed using QOS profiles defined below in section [21.1.3.3 “QOS profile configuration”](#).

The way the Type Of Service bits are used depends on the network manager. The original specification of the TOS bits defines a general structure for using the bits. DiffServ refines and makes more specific the use of the values. The use of the TOS bits in various scenarios is defined below, however a fuller discussion may be found at:

<http://www.aarnet.edu.au/engineering/networkdesign/qos/precedence.html>

### 21.1.1.1 Type Of Service values

The Type Of Service octet contains a 3 bit “precedence” value and 4 bits used to request “minimize delay”, “maximize throughput”, “maximize reliability”, and “minimize monetary cost” – the least significant bit of the octet must remain zero.

In RFC1349 the Type Of Service value is defined as:

```
MS 3 bits    = Precedence
Next 4 bits  = Type Of Service
LS bit      = Zero
```

The 3 bit Precedence field gives an increasing set of precedence:

```
000 -- priority 0, normal precedence
to
111 -- priority 7, network control (maximum precedence)
```

The value of Precedence used will depend on the design of the Network (and configuration of the Network routers), but in typical networks a good value for “precedence” for VoIP traffic is 5.

The 4 bit TOS field is constructed from the following bitmaps:

```
1000 -- minimize delay
0100 -- maximize throughput
0010 -- maximize reliability
0001 -- minimize monetary cost
0000 -- normal service
```

### 21.1.1.2 Diffserv

Diffserv is a specification that formalises the use of the TOS octet. From RFC2597, Diffserv has a notion of two data transfer schemes, “AF – Assured Forwarding” and “EF – Expedited Forwarding”

In Assured Forwarding, at LAN routers / switches:

- short term congestion will result in packets being queued
- long term congestion results in packets being dropped

**Assured Forwarding** uses 6 bits to identify 4 classes and 3 drop precedences (the 2 LS bits of the TOS octet remain zero):

	Class 1	Class 2	Class 3	Class 4
Low Drop precedence	AF11 = 001010 <sub>00</sub> (=40, 0x28)	AF21 = 010010 <sub>00</sub> (=72, 0x48)	AF31 = 011010 <sub>00</sub> (=104, 0x68)	AF41 = 100010 <sub>00</sub> (=136, 0x88)
Medium Drop precedence	AF12 = 001100 <sub>00</sub> (=48, 0x30)	AF22 = 010100 <sub>00</sub> (=80, 0x50)	AF32 = 011100 <sub>00</sub> (=112, 0x70)	AF42 = 100100 <sub>00</sub> (=144, 0x90)
High Drop precedence	AF13 = 001110 <sub>00</sub> (=56, 0x38)	AF23 = 010110 <sub>00</sub> (=88, 0x58)	AF33 = 011110 <sub>00</sub> (=120, 0x78)	AF43 = 100110 <sub>00</sub> (=152, 0x98)

**Expedited Forwarding** implies that this traffic is high priority traffic and should take precedence over **ALL** other LAN traffic. Packets are marked EF when they need to be transmitted across the Network with low latency and low jitter.

In Expedited Forwarding:

- This traffic takes precedence over all other traffic so long as the traffic rate stays within preset bounds.
- If the traffic rate is exceeded then the excess packets are dropped

Expedited Forwarding uses a single 6 bit value for identification (RFC2598), the 2 LS bits remain zero:

- 101110<sub>00</sub> (=184, 0xb8)

For VoIP traffic it is recommended that Expedited Forwarding is selected (set the TOS value to 184 (0xb8)).

### 21.1.2 Layer 2 (Ethernet Header) – 802.1p Class of Service tagging and 802.1q VLAN tagging

Vegas support the configuration of both 802.1p Class of Service tagging and 802.1q VLAN tagging. 802.1 p/q are layer 2 (Ethernet header) values that LAN bridges, layer 2 routers and switches can use to determine the priority of the IP packet in comparison to other suitably tagged packets.



**WARNING!**

**802.1 Ethernet headers are 4 bytes larger than standard Ethernet headers, and so may not be backward compatible with existing Ethernet systems – only enable 802.1 p/q functionality on your Vega if your network supports these packets, otherwise you may lose LAN connection with it.**

**NOTE**

If the Vega gateway is connected to an **access port** of an 802.1 p/q switch/router, you do not need to enable 802.1 p/q handling on the Vega because the switch/router will handle (add) the 802.1 p/q labelling of the LAN packets.

Only enable 802.1 p/q handling on the Vega if you need the Vega to specify the CoS (Class of Service / User Priority) or VLAN membership, or if you want to connect the Vega to a **trunk port** of an 802.1q enabled switch/router.

(A switch/router **access port** generally accepts both tagged and untagged LAN packets – the untagged packets will be assigned a VLAN ID and priority by the switch/router. VLAN tagged packets will usually be rejected if the VLAN ID is not the same as that configured for this port.

A **trunk port** will generally accept only VLAN tagged LAN packets – it will not check the VLAN ID – it will just pass on all packets)

The 802.1p (priority) can take a value in the range 0..7

0 = best effort ... priority really depends on configuration of network bridges, layer 2 routers and switches

1 to 7 = increasing priority; 7=highest priority

The 802.1q (Virtual LAN) defines a LAN ID which can take a value in the range 0 to 4095

### 21.1.3 Configuring QOS Profiles

For flexibility Vegas support the ability to configure a number of QOS profiles. The QOS profile that is used on a specific LAN packet depends on the currently active QOS profile. The active QOS profile is specified using configuration parameters in the Vega. If the LAN packet relates to a specific call, the dial planner can override the selection of QOS profile to be used.

The QOS profile to use is specified within a LAN\_profile. The various LAN applications call up which LAN profile (and therefore which QOS profile) to use for that application (e.g. calls, tftp, ftp etc.).

#### 21.1.3.1 Configuring QOS Profiles

The Qos profile to use in a specific circumstance is now selected by the LAN profile that has been selected for that circumstance. LAN profiles enable both the selection of a physical LAN interface (important for Vega 400) and the qos profile to use on that interface.

LAN profiles are defined for:

- ftp
- h.323
- h.323 gatekeeper
- http

- lan
- ntp
- sip
- telnet
- tftp

The Vega will use the qos profile called up by the “lan” lan\_profile for all IP data unless there is a more relevant lan, profile, e.g. tftp.lan\_profile (for tftp data).

### 21.1.3.2 Dial plan override of QOS profile

Specific QOS profiles can be selected for LAN packets associated with specific calls by specifying the QOS profile to use in the dial plan dest statement, using the token QOS:. QOS: can be specified for both calls being routed to the LAN and also for calls being received from the LAN.

**NOTE**

The Vega does not use the same QOS values that it receives for an incoming call in its responses for that call; the Vega must be configured appropriately (manually) to use the correct QOS settings.

For example, for a call being directed to the LAN:

```
dest=IF:05,TEL:<1>,TA:192.168.1.4,QOS:2
```

For a call being received from the LAN:

```
dest=IF:02,TEL:<1>,QOS:2
```

**NOTE**

When overriding QOS profiles in the dial planner ensure that `vlan_id` is configured appropriately. Typically the `vlan_id` should be the same as the VoIP protocol specific `vlan_id` because before a call is routed (and hence before the QOS profile override takes over) there may be ARPs or other messages between VoIP endpoints which must also be routed through appropriately.

### 21.1.3.3 QOS profile configuration

#### 21.1.3.3.1 Non 802.1 configuration

If the Vega is not configured for 802.1 operation then there are 4 configurable parameters in each QOS profile:

```
[lan.if.x.8021q]
    enable=0                ; disable 802.1 operation
    accept_non_tagged=1    ; accept non 802.1 LAN packets
                          ; as well as 802.1 packets

[qos_profile.n]
    name=default

[qos_profile.n.tos]
    default_priority=0     ; IP header TOS octet
    media_priority=0      ; IP header TOS octet
    signalling_priority=0 ; IP header TOS octet
```

The `media_priority` is used for media packets, ie audio RTP packets and T.38 packets



The `signalling_priority` is used for the VoIP signalling messages

The `default_priority` is used for any LAN traffic not associated with either call signalling or call media (e.g. Telnet messages and Radius accounting messages).

### 21.1.3.3.2 802.1 configuration

If the Vega is configured for 802.1 operation then there are 9 configurable parameters in each QoS profile:

```
[lan.if.x.8021q]
  enable=1                ; enable 802.1 operation
  accept_non_tagged=1     ; accept non 802.1 LAN packets
                          ; as well as 802.1 packets

[qos_profile.n]
  name=default

[qos_profile.n.tos]
  default_priority=0      ; IP header TOS octet
  media_priority=0       ; IP header TOS octet
  signalling_priority=0  ; IP header TOS octet

[qos_profile.n.8021q]
  default_priority=0      ; 802.1p priority
  media_priority=0       ; 802.1p priority
  signalling_priority=0  ; 802.1p priority
  vlan_id=0              ; 802.1q Virtual LAN ID
  vlan_name=Default
```

The `media_priority` is used for media packets, ie audio RTP packets and T.38 packets

The `signalling_priority` is used for the VoIP signalling messages

The `default_priority` is used for any LAN traffic not associated with either call signalling or call media (e.g. Telnet messages and Radius accounting messages).

The `vlan_id` specifies the 802.1q Virtual LAN id to be used for LAN packets sent using this profile. (All VoIP devices that need to communicate with each other must be configured with the same VLAN id number.)

The `vlan_name` is provided for self-documentation purposes only. It does not affect the information sent.

These items are configurable on the web browser interface on the [QoS](#) page – select [Modify](#) against the appropriate profile.



## 21.2 QoS Event Monitoring

Vegas may be configured to monitor certain QOS statistics, like jitter, buffer under / over –flows and packet loss. By monitoring their occurrence against thresholds the Vega can provide alerts when the thresholds are exceeded (and also when the problem recovers). Per-call and per-gateway QOS events may be selected for monitoring.

***For details on configuring QOS event monitoring in the Vega and details of the resulting alarms, see information note “IN 15 QOS Statistics”***

## 21.3 QoS Statistics Reports

Vegas can produce both per-call and per-gateway reports. These can be displayed either on demand from an internal buffer, or delivered live to a terminal interface.

***For details on configuring the Vega and the format of the resulting QOS statistics reports, see information note “IN 15 QOS Statistics”***

## APPENDIX A: SYSTEM EVENT LOG MESSAGES

System event log messages are created in the following format:

```
LOG: <time> <code area generating msg>
      (<seriousness>)R<reason code>C<channel number> <message>
```

The following tables provide details of the reason codes and seriousness values. For further details on reading LOG: messages, see section 9.

Reason Code (and seriousness)	Reason Code in Hex	Description
<b>0-99 (Info)</b>		
0	00	Entity/service starting
1	01	Incoming call
2	02	Outgoing call
3	03	Connect call
4	04	Disconnect
5	05	On-hook
6	06	Off-hook
7	07	No route to destination
8	08	DSP license limit reached
10	0A	Factory defaults restored
11	0B	Route found
12	0C	Time loaded from server
15	0F	Call blocked
16	10	Detected system clock speed
17	11	config parameter with 'auto' setting, has been set to default, as appropriate
18	12	config. Parameter with incompatible value has been changed to appropriate setting.
20	14	Profiles reduced to 40% of MAX when RAM < 16M (V100 prototypes)
21	15	Connect media
22	16	DHCP item discovery
23 <sup>17</sup>	17	Vega Reboot
24	18	Exceeded Max calls
25	19	Call congestion on an interface

---

<sup>17</sup> watchdog and fatal reboots are reported in the log as <seriousness> Alert, user and coldstart are <seriousness> Info

Vega Admin Guide R8.5 V1.5

Reason Code (and seriousness)	Reason Code in Hex	Description
<b>100-150 (Warning)</b>		
100	64	No services available
101	65	No default routes
103	66	Caller ID received after the call has progressed
104	68	DSP channel refused
105	69	ISDN card(s) failed
106	6A	Entity/service stopping
108	6C	DHCP discovery failed
111	6F	Billing record lost
112	70	Billing log approaching full
113	71	Entity message queue congested
114	72	TCP session aborted (keepalive timeout)
115	73	Entity message queue congestion released
116	74	Tone definition not written
117	75	Invalid tone definition
118	76	Too many tones in sequence
119	77	Tone in sequence does not exist
120	78	Invalid tone sequence definition
121	79	Tone sequence definition not written
122	7A	Illegal packet source
123	7B	SIP registration reconfigure in unhandled state
124	7C	DNS lookup failed for sip.default_proxy
130	82	Mismatch of configured lyr1 settings (Telogy 8 problem)
140	8C	Unable to read configuration
141	8D	CALL_BLOCKED option disabled
142	8E	Invalid dial plan configuration - An endpoint can only be assigned to one QoS profile

Reason Code (and seriousness)	Reason Code in Hex	Description
<b>150-170 (Fail)</b>		
150	96	DSP boot code load failure
151	97	DSP expected CODEC image absent
152	98	DSP boot code absent
153	99	DSP failure
154	9A	Open channel failure - detected by router
155	9B	SIP initial resource allocation failure -

Vega Admin Guide R8.5 V1.5

Reason Code (and seriousness)	Reason Code in Hex	Description
		sip.max_calls too large
156	9C	System Fan Failure
157	9D	ISDN card failure
170	AA	System Overheat / back to normal temperature

Reason Code (and seriousness)	Reason Code in Hex	Description
<b>171-190 (Alert)</b>		
171	AB	System is ready for use
172	AC	POTS incoming call
173	AD	DSL active
174	AE	DSL inactive
175	AF	Call rejected; whitelist match failed
176	B0	Call rejected; findroute failed
177	B1	Last active call terminated. New calls are blocked
178	B2	'apply' configuration changes complete
179	B3	N channels licensed
180	B4	LAN active
181	B5	LAN inactive
182	B6	Gatekeeper event
183	B7	An 'admin' user has just logged in
184	B8	Too many login failures
185	B9	Password changed for user
186	BA	Duplicate MAC address detected
187	BB	Boot-up script status reporting
188	BC	Number of licensed POTS ports
189	BD	Reboot due to IP address change by DHCP server
190	BE	VLAN values not preserved
191	BF	New calls unblocked
192	C0	QoS: Packet Loss below threshold for call number
193	C1	QoS: Packet playout delay below threshold
194	C2	QoS: Packet jitter below threshold
195	C3	QoS: Packet Loss threshold reached
196	C4	QoS: Packet playout delay threshold reached
197	C5	QoS: Packet jitter threshold reached
198	C6	QoS: Jitter buffer overflow for call reached
199	C7	QoS: Jitter buffer underflow for call
199	C7	QoS: IP Service available, LAN link restored
199	C7	QoS: IP Service unavailable due to LAN failure
199	C7	QoS: Packet playout error rate below threshold for call
199	C7	QoS: Packet playout error rate threshold reached for call

Vega Admin Guide R8.5 V1.5

Reason Code (and seriousness)	Reason Code in Hex	Description
199	C7	System Fan no longer failed

Reason Code (and seriousness)	Reason Code in Hex	Description
<b>200-255 (Error)</b>		
200	C8	No logical channel available for call
201	C9	H.323 preferred capability not in list
202	CA	H.323 first capability not G.723.1 or G.729AnnexA
203	CB	DSP - internal error
204	CC	Configuration syntax error
205	CD	Duplicate interface id found
206	CE	Too many interfaces registered
207	CF	Tone initialisation failed
208	D0	Tone sequence initialisation failed
209	D1	SIP WRITE data too long
210	D2	Invalid ISDN card hardware version for T1 mode
211	D3	Compressed web browser page is too big to unpack and display
255	FF	System power above threshold, returned below threshold.

## APPENDIX B: SIP SIGNALLING MESSAGES

The following SIP signalling messages are supported:

- Vega FXS gateways can transmit INFO messages indicating a flash-hook event
- Vega FXO gateways can receive INFO messages indicating a flash-hook event
- Vegas can transmit and receive INFO messages indicating DTMF events
- Vegas can receive INFO messages requesting playing of a tone (used to indicate “call-waiting”)
- Vegas can receive NOTIFY messages indicating if any voice messages are waiting
- Vega FXS gateways can handle “Alert-Info” headers in an incoming INVITE (used for generating distinctive ringing)

### INFO Messages

INFO messages allow the Vega to:

- 1) Inform SIP clients that a “flash hook” event has occurred.
- 2) Inform SIP clients that a DTMF event has occurred.
- 3) Receive a request to play a DTMF tone.
- 4) Receive a request to play a tone (e.g.call-waiting).

The INFO messages contain a Content-Type field that will be in the form:

`application/signalling_app_id`

where `signalling_app_id` is defined by the `sip.signalling_app_id` configuration parameter.

## INFO Messages – DTMF and Hookflash MESSAGE

The generation of DTMF and Hookflash INFO messages requires the codec configured for out-of-band DTMF and the Vega configured to send out INFO messages – not just RFC2833.

check also parameters:

```
[_advanced.sip.info]
  tx_hookflash
  tx_dtmf
```

sip.dtmf\_info=model (VegaStream standard):

Whenever a DTMF tone key is pressed on a POTS phone during a SIP call and the Vega detects that tone, it will send a message like this:

```
INFO sip:3019775337@192.168.2.175:5060 SIP/2.0
.
.
CSeq: 2 INFO
Content-Type: application/signalling_app_id
Content-Length: xx
event DTMF 1 {key}
```

Where **{key}** is a single character indicating the key pressed (0,1,2 .. #,\*)

When a hookflash event occurs, the Vega will send a message like this:

```
INFO sip:3019775337@192.168.2.175:5060 SIP/2.0
.
.
CSeq: 2 INFO
Content-Type: application/signalling_app_id
Content-Length: xx
event flashhook
```

sip.dtmf\_info=mode2 (Cisco compatible):

Whenever a DTMF tone key is pressed on a POTS phone during a SIP call or a hookflash event occurs, the Vega will send a message like this:

```
INFO sip:3019775337@192.168.2.175:5060 SIP/2.0
.
.
CSeq: 2 INFO
Content-Type: application/dtmf-relay
Content-Length: xx
Signal {key}
Duration 250
```

Where **{key}** is a single character indicating the key pressed (0,1,2 .. #,\*), a hookflash is indicated by **{key}** being the ! character.

**Duration** is always given as 250ms.



## INFO Messages – PLAY TONE MESSAGES

When the remote end wants the Vega to play a tone, it can activate this by sending a message like this:

```
INFO sip:3019775337@192.168.2.175:5060 SIP/2.0
.
.

CSeq: 2 INFO
Content-Type: application/signalling_app_id
Content-Length: xx
play tone preset 1
```

INFO message body	Configuration
<pre>play tone preset 1 Or: play tone CallWaitingTone1</pre>	tone defined by tones.callwait1_seq
<pre>play tone preset 2 Or: play tone CallWaitingTone2</pre>	tone defined by tones.callwait2_seq

E.g. for call waiting tone 1:

```
admin >show tones.callwait1_seq
[tones]
callwait1_seq=6
```

This points to the definition of tone sequence 6:

```
admin >show tones.seq.6
[tones.seq.6]
name=callwait1_seq
repeat=0
[tones.seq.6.tone.1]
duration=350
play_tone=7
```

## NOTIFY Messages

NOTIFY messages allow the Vega to receive notification of waiting voice messages.

```
NOTIFY sip:3019775337@192.168.2.153 SIP/2.0
.
.

Cseq: 1 NOTIFY
Content-Type: text/plain
Content-Length: xx
Messages-Waiting: mw
```

Where `mw` can be:

yes

no

`n` where `n=0,1,2,...` and specifies the number of waiting messages

When the Vega receives a message where `n>0` or `mw` is `yes`, then the Vega will:

- 1) Play a "stutter" dial-tone to the POTS user next time he/she takes the phone off-hook.
- 2) Send an MWI (message waiting indication) signal to the phone.

NOTE

1. The stutter dial-tone is specified by `tones.stutterd_seq`. This defines which tone sequence to use as the stutter dial-tone.

By default:

```
[tones]
stutterd_seq=2
```

2. To send an MWI signal to the phone, the Vega uses FSK tones. Some phones require a short voltage drop before the sending of the tones (like a hookflash) – this is not supported.

### INVITE Messages with Alert-Info

Vega FXS gateways can handle INVITE messages containing an "Alert-Info" field. The Alert-Info header will look something like this:

```
Alert-Info: bellcore-r1
```

The Vega will try to match up the alert type (in this case, "bellcore-r1") to an `_advanced.pots.ring.x.name` field in the configuration.

In this case, there would be a match with the following entry:

```
[_advanced.pots.ring.4]
name=bellcore-r1
frequency=20
repeat=1
ring1_on=350
ring1_off=350
ring2_on=900
ring2_off=300
ring3_on=350
ring3_off=3700
```

LIMITATIONS: This currently only works on calls on POTS interfaces that are in group 1, e.g.

```
pots.port.3.if.1
```

When NO "Alert-Info" field is present, then the Vega FXS port will use the ring specified by:

pots.port.x.if.1.ring\_index

where x (1-8) is the called POTS interface.

If the "Alert-Info" field is present, then the Vega will try to use the ring specified.

### **INVITE Message Session Description**

Some systems require the "c=" line to be in in the SDP media description, others require it in the SDP session description. Vegas can support either requirement based on the configuration of the parameter:

\_advanced.sip.sdp.ssess\_desc\_connection=0

the "c=" line appears in the SDP media description. For example:

```
v=0
o=Vega50 7 1 IN IP4 136.170.208.245
s=Sip Call
t=0 0
m=audio 10012 RTP/AVP 0
c=IN IP4 136.170.208.245
a=rtpmap:0 PCMU/8000
```

\_advanced.sip.sdp.ssess\_desc\_connection=1

the "c=" line appears in the SDP session description. For example:

```
v=0
o=Vega50 8 1 IN IP4 136.170.208.245
s=Sip Call
c=IN IP4 136.170.208.245
t=0 0
m=audio 10014 RTP/AVP 0
a=rtpmap:0 PCMU/8000
```

**APPENDIX C: DTMF TONE FREQUENCIES**

Frequency (Hz)		1209Hz	1336Hz	1477Hz	1633Hz
	Frequency (Hex)	0x4b9	0x538	0x5c5	0x661
697Hz	0x2b9	1	2	3	A
770Hz	0x302	4	5	6	B
852Hz	0x354	7	8	9	C
941Hz	0x3ad	*	0	#	D

**APPENDIX D: HEXADECIMAL TO DECIMAL CONVERSION**

Hex	Dec	Hex	Dec	Hex	Dec	Hex	Dec	Hex	Dec	Hex	Dec	Hex	Dec	Hex	Dec
00	0	20	32	40	64	60	96	80	128	A0	160	C0	192	E0	224
01	1	21	33	41	65	61	97	81	129	A1	161	C1	193	E1	225
02	2	22	34	42	66	62	98	82	130	A2	162	C2	194	E2	226
03	3	23	35	43	67	63	99	83	131	A3	163	C3	195	E3	227
04	4	24	36	44	68	64	100	84	132	A4	164	C4	196	E4	228
05	5	25	37	45	69	65	101	85	133	A5	165	C5	197	E5	229
06	6	26	38	46	70	66	102	86	134	A6	166	C6	198	E6	230
07	7	27	39	47	71	67	103	87	135	A7	167	C7	199	E7	231
08	8	28	40	48	72	68	104	88	136	A8	168	C8	200	E8	232
09	9	29	41	49	73	69	105	89	137	A9	169	C9	201	E9	233
0A	10	2A	42	4A	74	6A	106	8A	138	AA	170	CA	202	EA	234
0B	11	2B	43	4B	75	6B	107	8B	139	AB	171	CB	203	EB	235
0C	12	2C	44	4C	76	6C	108	8C	140	AC	172	CC	204	EC	236
0D	13	2D	45	4D	77	6D	109	8D	141	AD	173	CD	205	ED	237
0E	14	2E	46	4E	78	6E	110	8E	142	AE	174	CE	206	EE	238
0F	15	2F	47	4F	79	6F	111	8F	143	AF	175	CF	207	EF	239
10	16	30	48	50	80	70	112	90	144	B0	176	D0	208	F0	240
11	17	31	49	51	81	71	113	91	145	B1	177	D1	209	F1	241
12	18	32	50	52	82	72	114	92	146	B2	178	D2	210	F2	242
13	19	33	51	53	83	73	115	93	147	B3	179	D3	211	F3	243
14	20	34	52	54	84	74	116	94	148	B4	180	D4	212	F4	244
15	21	35	53	55	85	75	117	95	149	B5	181	D5	213	F5	245
16	22	36	54	56	86	76	118	96	150	B6	182	D6	214	F6	246
17	23	37	55	57	87	77	119	97	151	B7	183	D7	215	F7	247
18	24	38	56	58	88	78	120	98	152	B8	184	D8	216	F8	248
19	25	39	57	59	89	79	121	99	153	B9	185	D9	217	F9	249
1A	26	3A	58	5A	90	7A	122	9A	154	BA	186	DA	218	FA	250
1B	27	3B	59	5B	91	7B	123	9B	155	BB	187	DB	219	FB	251
1C	28	3C	60	5C	92	7C	124	9C	156	BC	188	DC	220	FC	252
1D	29	3D	61	5D	93	7D	125	9D	157	BD	189	DD	221	FD	253
1E	30	3E	62	5E	94	7E	126	9E	158	BE	190	DE	222	FE	254
1F	31	3F	63	5F	95	7F	127	9F	159	BF	191	DF	223	FF	255